

**Version
December 2013**

Add-on Module

RF-STEEL SP

**Ultimate Limit State and Serviceability
Limit State Design According to
SP 16.13330.2011 –
Updated Edition of SNIIP II-23-81***

Program Description

All rights, including those of translations, are reserved.

No portion of this book may be reproduced – mechanically, electronically, or by any other means, including photocopying – without written permission of DLUBAL SOFTWARE GMBH.

© **Dlubal Software GmbH**
Am Zellweg 2 D-93464 Tiefenbach

Tel.: +49 9673 9203-0
Fax: +49 9673 9203-51
E-Mail: info@dlubal.com
Web: www.dlubal.com

Contents

Contents		Page	Contents		Page
1.	Introduction	4	4.6	Governing Internal Forces by Member	33
1.1	Additional Module RF-STEEL SP	4	4.7	Governing Internal Forces by Set of Members	34
1.2	RF-STEEL SP Team	5	4.8	Member Slendernesses	35
1.3	Using the Manual	5	4.9	Parts List by Member	36
1.4	Starting RF-STEEL SP	6	4.10	Parts List by Set of Members	37
2.	Input Data	8	5.	Results Evaluation	38
2.1	General Data	8	5.1	Results in the RFEM Model	39
2.1.1	Ultimate Limit State	9	5.2	Result Diagrams	41
2.1.2	Serviceability Limit State	11	5.3	Filter for Results	42
2.2	Materials	12	6.	Printout	44
2.3	Cross-Sections	14	6.1	Printout Report	44
2.4	Intermediate Lateral Restraints	18	6.2	RF-STEEL SP Graphic Printout	44
2.5	Effective Lengths - Members	19	7.	General Functions	46
2.6	Effective Lengths - Sets of Members	22	7.1	Design Cases	46
2.7	Serviceability Data	23	7.2	Cross-Section Optimization	48
2.8	Parameters - Members	24	7.3	Units and Decimal Places	50
3.	Calculation	25	7.4	Data Transfer	51
3.1	Details	25	7.4.1	Export Material to RFEM	51
3.2	Start Calculation	27	7.4.2	Export Effective Lengths to RFEM	51
4.	Results	28	7.4.3	Export Results	51
4.1	Design by Load Case	29	8.	Example	53
4.2	Design by Cross-Section	30	A	Literature	58
4.3	Design by Set of Members	31	B	Index	59
4.4	Design by Member	32			
4.5	Design by x-Location	32			

1. Introduction

1.1 Additional Module RF-STEEL SP

The Russian Standard *SP 16.13330.2011* determines rules for the design, analysis and construction of steel buildings in the Russian Federation. With the add-on module RF-STEEL SP from the DLUBAL SOFTWARE GMBH company all users obtain a highly efficient and universal tool to design steel structures according to this standard.

All typical designs of load capacity, stability and deformation are carried out in the module RF-STEEL SP. Different actions are taken into account during the load capacity design. RF-STEEL SP automatically calculates the limiting width-to-thickness ratios of compressed parts and carries out the slenderness check of cross-section automatically.

The sectional coordinate system in RF-STEEL SP is different from the indices used in the Russian code. It corresponds to the one used in RFEM: The indices "y" and "z" refer to the axes in the cross-section plane as seen in the image to the left.

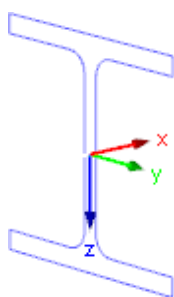

Axis system

For the stability design, you can determine for every single member or set of members whether buckling is possible in the direction of y-axis and/or z-axis. Lateral supports can be added for a realistic representation of the structural model. The specific ratios of slendernesses and critical stresses are automatically determined by RF-STEEL SP on the basis of the boundary conditions. The location where the loads are applied, which influences the lateral torsional design, can be defined in the detailed settings.

The serviceability limit state has become important for the static calculation of modern civil engineering as more and more slender cross-sections are being used. In RF-STEEL SP, load cases, load combinations and result combinations can be arranged individually to cover the various design situations.

If required, you can use the add-on module to optimize cross-sections and export the modified cross-sections to RFEM. Using the design cases, you can design separate structural components in complex structures or analyze variants.

RF-STEEL SP is an add-on module integrated in RFEM. For this reason, the design relevant input data is already preset when you have started the module. Subsequent to the design, you can use the graphical RFEM user interface to evaluate the results. Finally, the design process can be documented in the global printout report, from determination of internal forces to design.

We hope you will enjoy working with RF-STEEL SP.

Your DLUBAL Team

1.2 RF-STEEL SP Team

The following people participated in the development of the RF-STEEL SP module:

Program Coordinators

Dipl.-Ing. Georg Dlubal
Dipl.-Ing. (FH) Younes El Frem

Ing. Ph.D. Peter Chromiak

Programmers

Ing. Zdeněk Kosáček
Ing. Ph.D. Peter Chromiak
Ing. Martin Budáč
Mgr. Petr Oulehle

Dipl.-Ing. Georg Dlubal
Dr.-Ing. Jaroslav Lain
Ing. Zbyněk Zámečník
Ing. Jakub Melka

Library of Cross-Sections and Materials

Ing. Ph.D. Jan Rybín
Stanislav Krytinář

Jan Brnušák

Design of Program, Dialog Boxes and Icons

Dipl.-Ing. Georg Dlubal
MgA. Robert Kolouch

Ing. Jan Miléř

Testing and Technical Support

Ing. Martin Hlavačka
Ing. Ph.D. Peter Chromiak
Dipl.-Ing. (BA) Markus Baumgärtel
M.Sc. Sonja von Bloh
Dipl.-Ing. (FH) Steffen Clauß
Dipl.-Ing. (FH) René Flori
Dipl.-Ing. (FH) Walter Fröhlich

Dipl.-Ing. (FH) Wieland Götzler
Dipl.-Ing. (FH) Ulrich Lex
Dipl.-Ing. (BA) Andreas Niemeier
Dipl.-Ing. (FH) Walter Rustler
M.Sc. Dipl.-Ing. (FH) Frank Sonntag
Dipl.-Ing. (FH) Lukas Sühnel
Dipl.-Ing. (FH) Robert Vogl

Manuals, Documentation and Translations

Ing. Ph.D. Peter Chromiak
Dipl.-Ing. (FH) Robert Vogl
Ing. Ladislav Kábrt

Dipl.-Ing. Frank Faulstich
MA Translation Anton Mitleider
Ing. Dmitry Bystrov

1.3 Using the Manual

Topics like installation, graphical user interface, results evaluation, and printout are described in detail in the manual of the main program RFEM. The present manual focuses on typical features of the add-on module RF-STEEL SP.



The descriptions in this manual follow the sequence and structure of the module's input and results windows. The text of the manual shows the described **buttons** in square brackets, for example [View mode]. At the same time, they are pictured on the left. **Expressions** appearing in dialog boxes, windows, and menus are set in *italics* to clarify the explanations.

At the end of the manual, you find the index. However, if you don't find what you are looking for, please check our website www.dlubal.com where you can go through our comprehensive FAQ pages by selecting particular criteria.

1.4 Starting RF-STEEL SP

RFEM provides the following options to start the add-on module RF-STEEL SP.

Menu

To start the program in the RFEM menu bar, click

Add-on Modules → Design - Steel → RF-STEEL SP.

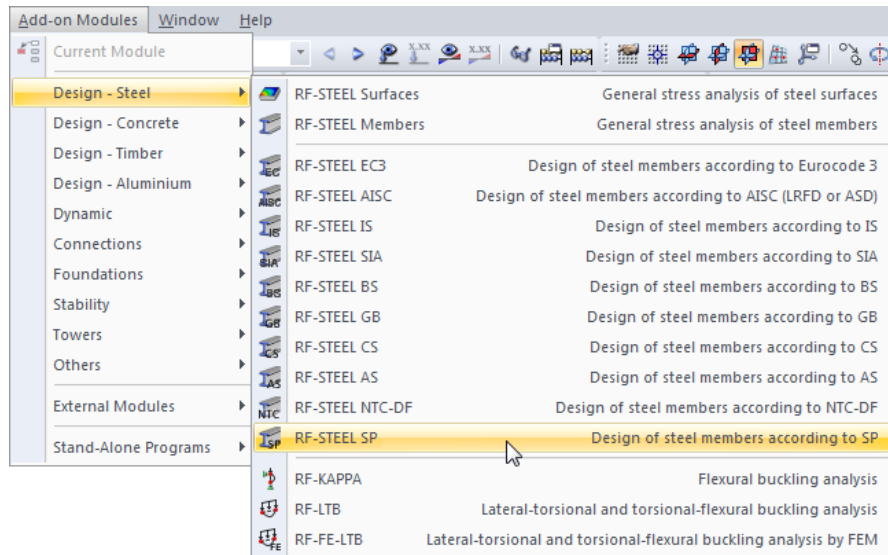

Figure 1.1: Main Menu: *Add-on Modules → Design - Steel → RF-STEEL SP*

Navigator

You can also start the add-on module in the *Data* navigator by clicking

Add-on Modules → RF-STEEL SP.

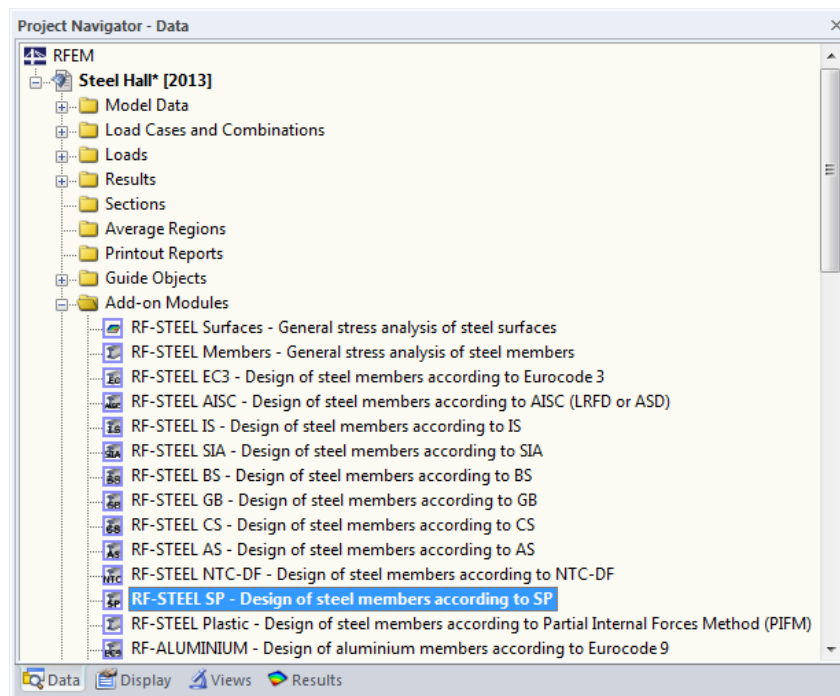
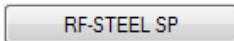
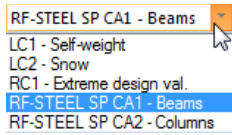

Figure 1.2: Data Navigator: *Add-on Modules → RF-STEEL SP*



Panel

If results from RF-STEEL SP are already available in the RFEM model, you can also open the design module in the panel:

Set the relevant RF-STEEL SP design case in the load case list of the RFEM toolbar. Then click the button [Show Results] to display the design criterion on the members graphically.

When the results display is activated, the panel is available, too. Now you can click the button [RF-STEEL SP] in the panel to open the module.

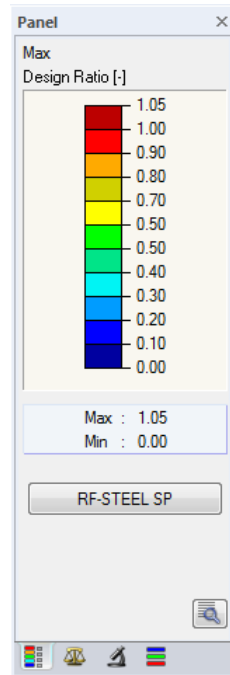

Figure 1.3: Panel button [RF-STEEL SP]

2. Input Data

When you have started the add-on module, a new window opens. In this window, a Navigator is displayed on the left, managing the windows that can be currently selected. The drop-down list above the navigator contains the design cases (see chapter 7.1, page 46).

The design relevant data is defined in several input windows. When you open RF-STEEL SP for the first time, the following parameters are imported automatically:

- Members and sets of members
- Load cases, load combinations, and result combinations
- Materials
- Cross-sections
- Effective lengths
- Internal forces (in background, if calculated)

To select a window, click the corresponding entry in the navigator. To set the previous or next input window, use the buttons shown on the left. You can also use the function keys to select the next [F2] or previous [F3] window.

Click [OK] to save the results. Thus you exit RF-STEEL SP and return to the main program. If you click [Cancel], you exit the module but without saving the data.



2.1 General Data

In window 1.1 *General Data*, you select the members, sets of members, and actions that you want to design. The tabs are managing the load cases, load combinations, and result combinations for the different designs.

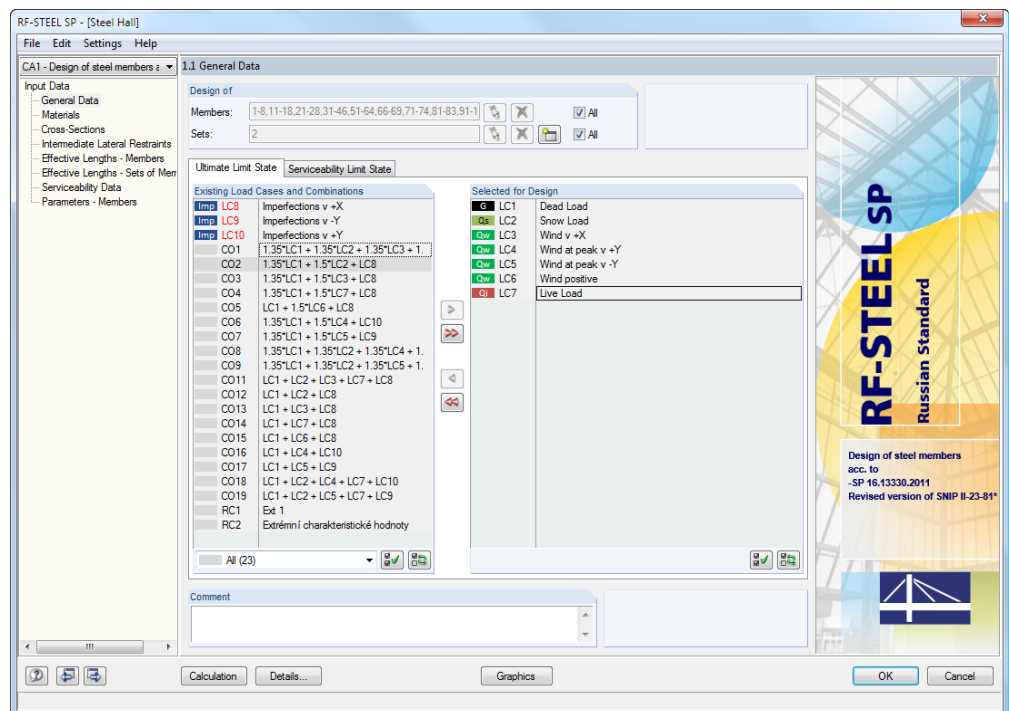

Figure 2.1: Window 1.1 *General Data*

Design of

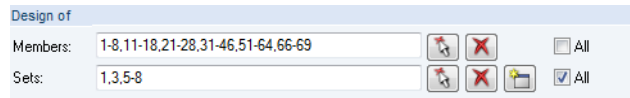

Figure 2.2: Design of members and sets of members



The design can be carried out for *Members* as well as for *Sets of Members*. If you want to design only selected objects, clear the *All* check box: Then you can access the input fields to enter the numbers of the relevant members or sets of members. The list of the numbers preset in the field can be selected by double-clicking and overwritten by entering the data manually. Alternatively, you can select the objects graphically in the RFEM work window after clicking [↖].

When you design a set of members, the program determines the extreme values of the designs of all members contained in the set of members and takes into account the boundary conditions of connected members for the stability analysis. The results are shown in the result windows 2.3 *Design by Set of Members*, 3.2 *Governing Internal Forces by Set of Members*, and 4.2 *Parts List by Set of Members*.



Click [New] to create a new set of members. The dialog box that you already know from RFEM appears where you can specify the parameters for a set of members.

2.1.1 Ultimate Limit State

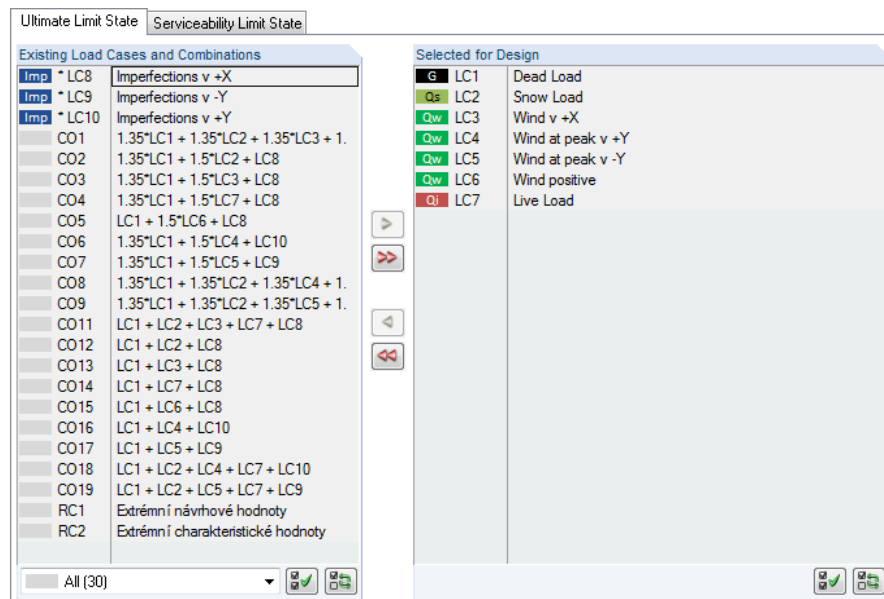

Figure 2.3: Window 1.1 *General Data*, *Ultimate Limit State* tab

Existing Load Cases and Combinations

This column lists all load cases, load combinations, and result combinations created in RFEM.



Click [▶] to transfer selected entries to the list *Selected for Design* on the right side. You can also double-click the items. To transfer the complete list to the right, click [▶▶].



To transfer multiple entries at once, select them while pressing the [Ctrl] key, as common for Windows applications.

Load cases marked by an asterisk (*), like load cases 8 to 10 in Figure 2.3, cannot be designed: This happens when the load cases are defined without any load data or the load cases contain only imperfections. When you transfer the load cases, a corresponding warning appears.

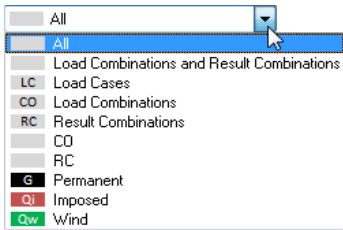

At the end of the list, several filter options are available. They will help you assign the entries sorted by load case, load combination, or action category. The buttons have the following functions:



	Select all cases in the list.
	Invert selection of load cases.

Table 2.1: Buttons in tab *Ultimate Limit State*

Selected for Design

The column on the right lists the load cases, load and result combinations selected for design. To remove selected items from the list, click [◀] or double-click the entries. To transfer the entire list to the left, click [◀◀].

The design of an enveloping max/min result combination is performed faster than the design of all contained load cases and load combinations. However, the analysis of a result combination has also disadvantages: First, the influence of the contained loads is difficult to discern.

Second, for the determination of the elastic critical moment for lateral-torsional buckling, the envelope of the moment distributions is analyzed, from which the most unfavorable distribution (max or min) is taken. However, this distribution only rarely reflects the moment distribution in the individual load combinations. Thus, in the case of a RC design, more unfavorable values for the elastic critical moment are to be expected, leading to higher ratios.

Result combinations should be selected for design only for dynamic combinations. For "usual" combinations, load combinations are recommended.



2.1.2 Serviceability Limit State

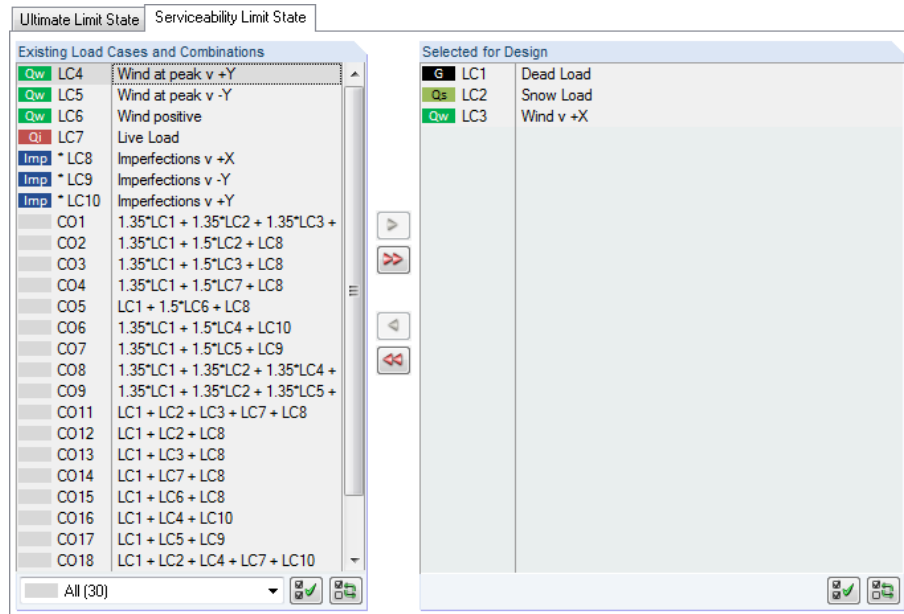

Figure 2.4: Window 1.1 *General Data*, *Serviceability Limit State* tab

Existing Load Cases and Combinations

This section lists all load cases, load and result combinations created in RFEM.

Selected for Design

Load cases, load and result combinations can be added or removed, as described in chapter 2.1.1.

The limit values of the deformations are controlled by the settings in the *Details* dialog box (see Figure 3.1, page 25) which you can call up by clicking the [Details] button.

In the window 1.7 *Serviceability Data*, the reference lengths decisive for the deformation check are managed (see chapter 2.7, page 23).

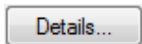

2.2 Materials

The window consists of two parts. In the upper part, all materials created in RFEM are listed. In the *Material Properties* section, the properties of the current material, that is, the table row currently selected in the upper section, are displayed.

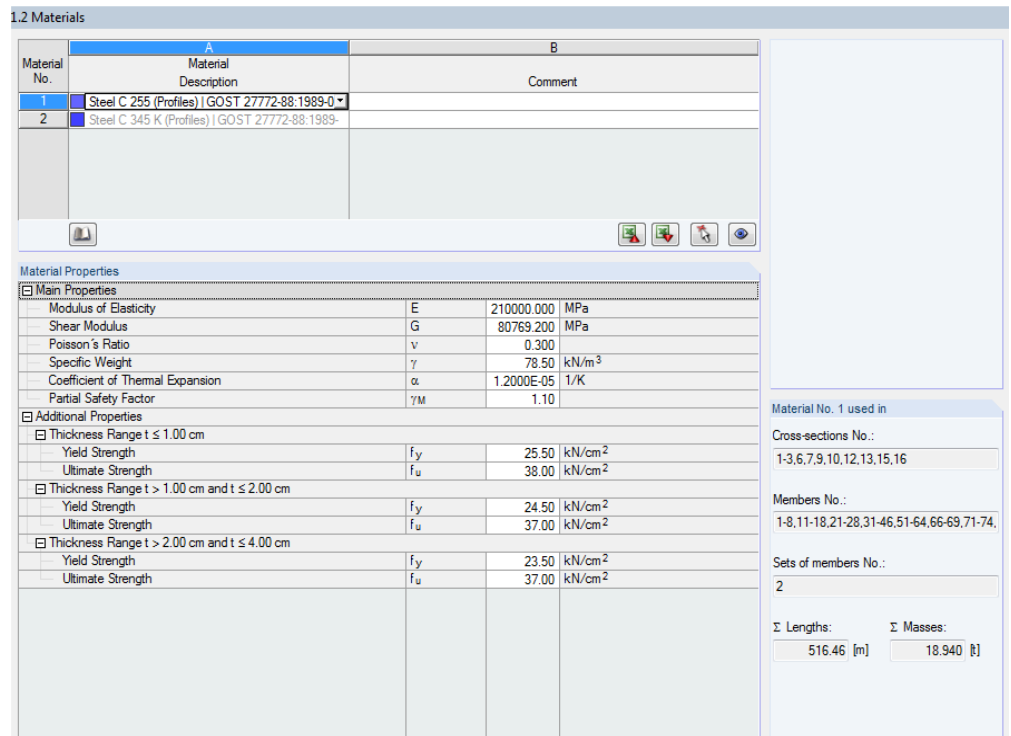

Figure 2.5: Window 1.2 *Materials*

Materials that will not be used in the design are dimmed. Materials that are not allowed are highlighted in red. Modified materials are displayed in blue.

The material properties required for the determination of internal forces are described in chapter 4.3 of the RFEM manual (*Main Properties*). The material properties required for design are stored in the global material library. The values are preset (*Additional Properties*).

To adjust the units and decimal places of material properties and stresses, select in the module's menu **Settings** → **Units and Decimal Places** (see chapter 7.3, page 50).

Material Description

The materials defined in RFEM are already preset, but it is always possible to modify them: To select the field, click the material in column A. Then click [▼] or press function key [F7] to open the material list.

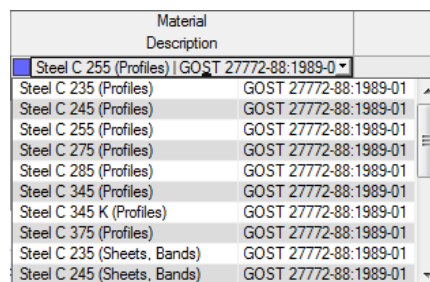

Figure 2.6: List of materials

According to the design concept of SP 16.13330.2011 [1], you can select only materials of the “Steel” category.

When you have imported a material, the design relevant *Material Properties* are updated.

If you change the material description manually and the entry is stored in the material library, RF-STEEL SP will import the material properties, too.

Principally, it is not possible to edit the material properties in the add-on module RF-STEEL SP.

Material Library

Numerous materials are already available in the library. To open the corresponding dialog box, click



Edit → Material Library

or use the button shown on the left.

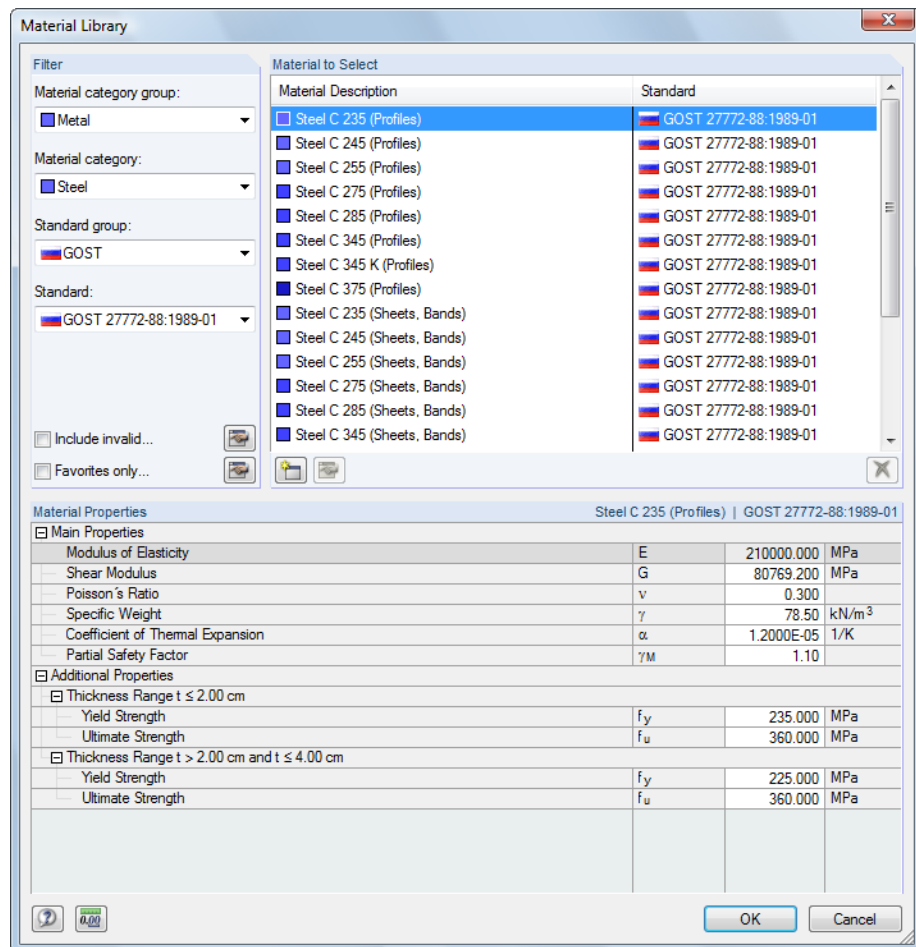

Figure 2.7: Dialog box *Material Library*

In the *Filter* section, *Steel* is preset as material category. Select the steel grade that you want to use for the design in the list *Material to Select*. The corresponding properties can be checked in the dialog section below.

Click [OK] or [↵] to transfer the selected material to window 1.2 of the module RF-STEEL SP.

Chapter 4.3 in the RFEM manual describes in detail how materials can be filtered, added, or rearranged.

You can also select material categories like *Cast Iron* or *Stainless Steel*. Please check, however, whether these materials are covered by the design concept of the Code [1].

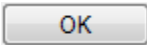

2.3 Cross-Sections

This window manages the cross-sections used for design. In addition, the window allows you to specify optimization parameters.

Coordinate System



The sectional coordinate system in RF-STEEL SP is different from the indices used in the Russian standard. It corresponds to the one used in RFEM (see image in Figure 2.8): The **y**-axis is the major principal axis of the cross-section, the **z**-axis the minor axis. This coordinate system is used for both the input data and the results.

1.3 Cross-Sections

Section No.	A	B	C	D	E	F	G
Material No.	Cross-Section Description	Cross-Section Type for Classification	Max. Design Ratio	Optimize	Remark	Comment	
1	1	I IP-B 55 B1 GOST, 1994	I-section rolled	0.64	No		
2	1	I IP-B 40 B1 GOST, 1994	I-section rolled	1.11	No		
3	1	I IP 40 B1 GOST 26020-83	I-section rolled	1.11	From current row		
6	1	I IP-K 20 K2 GOST, 1994	I-section rolled	0.15	No		
7	1	I IP-K 20 K2 GOST, 1994	I-section rolled	0.09	No		
9	1	I IP-B 35 B2 GOST, 1994	I-section rolled	0.70	No		
10	1	HP 200x54 CAN/CSA-S1	I-section rolled	0.06	No		
12	1	QRO 70x5 GOST 30245-	Box rolled	0.08	No		
13	1	Circle 24	General	0.04	No		
15	1	I IP-K 25 K2 GOST, 1994	I-section rolled	0.05	No		
16	1	I IP-B 25 B1 GOST, 1994	I-section rolled	0.71	No		
17	1	L 160x100x12 GOST 851	Angle		No	5)	
18	1	TU 250/50/100/10/6/0	General		No	5)	

1 - IP-B 55 B1 | GOST, 1994

[mm]

Cross-Section Values - IP-B 55 B1 | GOST, 1994

Cross-Section Type		I-section rolled
Section Height	h	543.0 mm
Section Width	b	220.0 mm
Web Thickness	t _w	9.5 mm
Flange Thickness	t _f	13.5 mm
Root Radius	r	24.0 mm
Area of Cross-Section	A	11336.0 mm ²
Shear Area	A _{vy}	5940.0 mm ²
Shear Area	A _{w,z}	5158.5 mm ²
Moment of Inertia	I _y	5.56820E+0 mm ⁴
Moment of Inertia	I _z	24045000.0 mm ⁴
Torsional Constant	I _t	508324.0 mm ⁴
Radius of Gyration	r _y	221.6 mm
Radius of Gyration	r _z	46.1 mm
Elastic Section Modulus	W _{yn,min}	2050900.0 mm ³
Elastic Section Modulus	W _{zn,min}	218600.0 mm ³
Plastic Section Modulus	Z _{py}	2330200.0 mm ³

Cross-section No. 1 used in

Members No.:

1,2,11,12,21,22,31,32,39,40

Sets of members No.:

2

Σ Lengths: 48.00 [m] Σ Masses: 4.271 [t]

Material:

1 - Steel C 235 (Profiles)

Figure 2.8: Window 1.3 Cross-Sections

Cross-Section Description

The cross-sections defined in RFEM are preset together with the assigned material numbers.

To modify a cross-section, click the entry in column B selecting this field. Click [Cross-section Library] or [...] in the field or press function key [F7] to open the cross-section table of the current input field (see the following figure).



In this dialog box, you can select a different cross-section or a different cross-section table. To select a different cross-section category, click [Back to cross-section library] to access the general cross-section library.

Chapter 4.13 of the RFEM manual describes how cross-sections can be selected from the library.

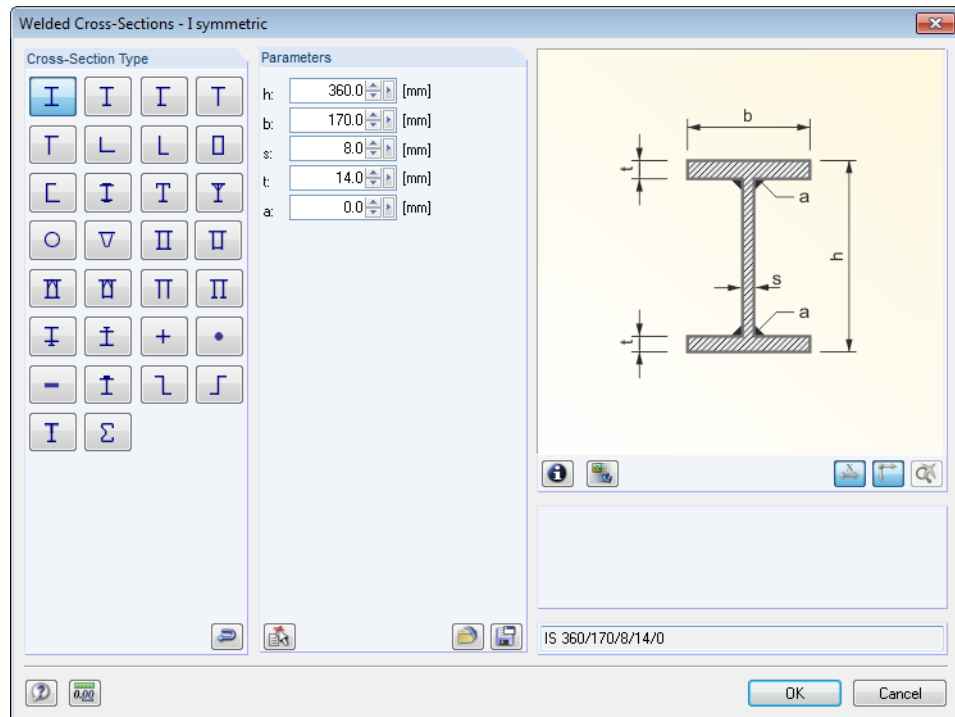
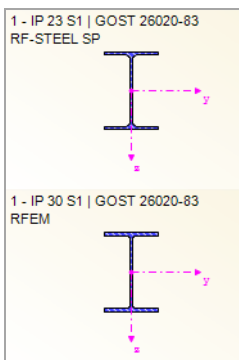

Figure 2.9: IS cross-sections in the cross-section library



The new cross-section description can be entered in the input field directly. If the data base contains an entry, RF-STEEL SP imports these cross-section parameters, too.

A modified cross-section will be highlighted in blue.

If cross-sections set in RF-STEEL SP are different from the ones used in RFEM, both cross-sections are displayed in the graphic in the right part of the window. The designs will be performed with the internal forces from RFEM for the cross-section selected in RF-STEEL SP.

Cross-Section Type for Classification

The cross-section type used for the classification is displayed, e.g. I-shape rolled, welded, box, round bar, etc. Cross-sections that are not covered by the standard are classified as *General*.

Max. Design Ratio

This table column is displayed only after the calculation. It is a decision support for the optimization. By means of the displayed design ratio and colored relation scales, you can see which cross-sections are little utilized and thus oversized, or overloaded and thus undersized.

Optimize

You can optimize every cross-section from the library: For the RFEM internal forces, the program searches the cross-section in the same table that comes as close as possible to a user-defined maximum ratio. The maximum ratio can be defined in the *Details* dialog box (see Figure 3.1, page 25).

If you want to optimize a cross-section, open the drop-down list in column D or E and select the desired entry: *From Current Row* or, if available, *From favorites 'Description'*. Recommendations for the cross-section optimization can be found in chapter 7.2 on page 48.

Remark

This column shows remarks in the form of footers that are described in detail below the cross-section list.



A warning might appear before the calculation: *Incorrect type of cross-section!* This means that there is a cross-section that is not registered in the data base. This may be a user-defined cross-section, or a SHAPE-THIN cross-section that has not been calculated yet. To select an appropriate cross-section for design, click [Library] (see description after Figure 2.8).

Member with tapered cross-section

For tapered members with different cross-sections at the member start and member end, the module displays both cross-section numbers in two rows, in accordance with the definition in RFEM.

RF-STEEL SP also designs tapered members, provided that the cross-section at the member's start has the same number of stress points as the cross-section at the member end. For example, the normal stresses are determined from the moments of inertia and the centroidal distances of the stress points. If the start and the end cross-section of a tapered member have not the same number of stress points, the intermediate values cannot be interpolated. The calculation is possible neither in RFEM nor in RF-STEEL SP.



The cross-section's stress points including numbering can also be checked graphically: Select the cross-section in window 1.3 and click [Info]. The dialog box shown in Figure 2.10 appears.

Info About Cross-Section



In the dialog box *Info About Cross-Section*, you can view the cross-section properties, stress points and c/t-parts.

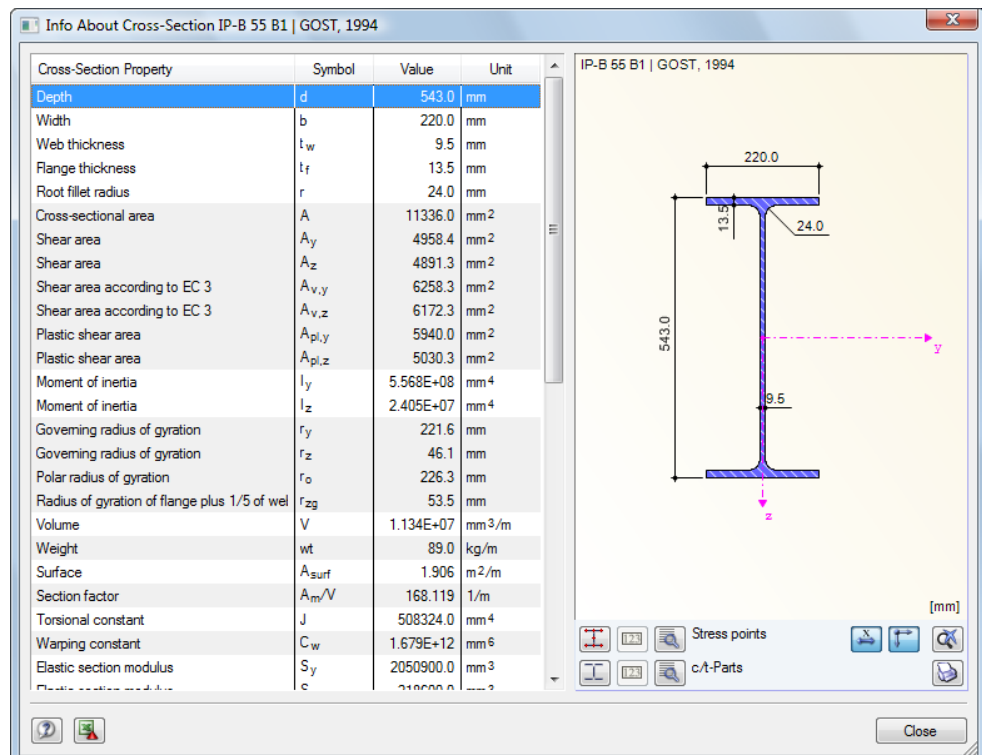

Figure 2.10: Dialog box *Info about Cross-Section*

In the right part of the dialog box, the currently selected cross-section is displayed.

The buttons below the graphic have the following functions:







Button	Function
	Displays or hides the stress points
	Displays or hides the c/t-parts
	Displays or hides the numbering of stress points or c/t-parts
	Displays or hides the details of the stress points or c/t-parts (see Figure 2.11)
	Displays or hides the dimensions of the cross-section
	Displays or hides the principal axes of the cross-section
	Resets the full view of the cross-section graphic

Table 2.2: Buttons of cross-section graphic



Click [Details] to call up detailed information on stress points (distance to center of gravity, statlcal moments of area, normalized warping constants etc.) and c/t-parts.

Stress Points of IP-B 55 B1 | GOST, 1994

StressP No.	Coordinates		Statlcal Moments of Area		Thickness t [mm]	Warping	
	y [mm]	z [mm]	Q _y [mm ³]	Q _z [mm ³]		W _{no} [mm ²]	S _w [mm ⁴]
1	-110.0	-271.5	0.0	0.0	13.5	29122.5	0.0
2	-28.8	-271.5	-290180.0	-76080.0	13.5	7611.6	-20146300.0
3	0.0	-271.5	-403184.0	-82400.5	13.5	0.0	-21623500.0
4	28.8	-271.5	-290180.0	76080.0	13.5	-7611.6	20146300.0
5	110.0	-271.5	0.0	0.0	13.5	-29122.5	0.0
6	-110.0	271.5	0.0	0.0	13.5	-29122.5	0.0
7	-28.8	271.5	-290398.0	76095.7	13.5	-7611.6	-20146300.0
8	0.0	271.5	-403184.0	82400.5	13.5	0.0	-21623500.0
9	28.8	271.5	-290398.0	-76095.7	13.5	7611.6	20146300.0
10	110.0	271.5	0.0	0.0	13.5	29122.5	0.0
11	0.0	-234.0	-901745.0	0.0	9.5	0.0	0.0
12	0.0	234.0	-903270.0	0.0	9.5	0.0	0.0
13	0.0	0.0	-1.16E+06	0.0	9.5	0.0	0.0

IP-B 55 B1

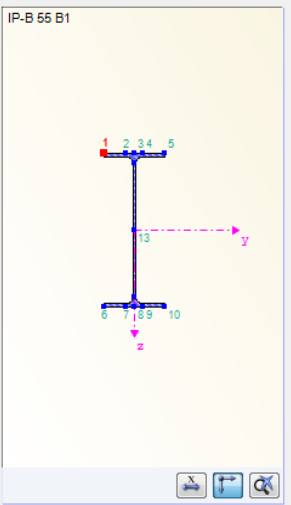

Close

Figure 2.11: Dialog box *Stress Points of IP-B 55 B1*

2.4 Intermediate Lateral Restraints

In window 1.4, you can define intermediate lateral restraints for members. RF-STEEL SP always assumes this kind of support to be perpendicular to the cross-section's minor axis z (see Figure 2.8). Thus, it is possible to influence the members' effective lengths which are important for the design of column buckling and lateral torsional buckling.



For the calculation, all intermediate lateral restraints are considered as torsional supports.

1.4 Intermediate Lateral Restraints

Member No.	A Lateral Restraint	B Length L [m]	C Number	D x ₁	E x ₂	F x ₃	G x ₄	H x ₅	I x ₆	J x ₇	K x ₈	L x ₉
1	<input checked="" type="checkbox"/>	6.000	1	0.500								
2	<input type="checkbox"/>	6.000										
3	<input checked="" type="checkbox"/>	3.011	2	0.333	0.667							
4	<input type="checkbox"/>	3.262										
5	<input checked="" type="checkbox"/>	6.274	4	0.200	0.400	0.600	0.800					
6	<input type="checkbox"/>	6.274										
7	<input type="checkbox"/>	3.262										
8	<input type="checkbox"/>	3.011										
11	<input type="checkbox"/>	6.000										
12	<input type="checkbox"/>	6.000										

Relatively (0 ... 1)

Settings - Member No. 5

Cross-Section	2 - IP-B 40 B1 GOST, 1994	
Lateral Restraints	<input checked="" type="checkbox"/>	
Member Length	L	6.274 m
Number of Intermediate Lateral Restraints	n	4
Location of Lateral Restraint No. 1	x ₁	0.200
Location of Lateral Restraint No. 2	x ₂	0.400
Location of Lateral Restraint No. 3	x ₃	0.600
Location of Lateral Restraint No. 4	x ₄	0.800

Set input for members No.: All

Figure 2.12: Window 1.4 *Intermediate Lateral Restraints*

In the upper part of the window, you can assign up to nine lateral supports for each member. The *Settings* section shows the input as column overview for the member selected above.



To define the intermediate restraints of a member, select the *Lateral Restraint* check box in column A. To graphically select the member and to activate its row, click [↵]. By selecting the check box, the other columns become available for you to enter the parameters.

In column C, you specify the number of the intermediate restraints. Depending on the specification, one or more of the following *Intermediate Lateral Restraints* columns for the definition of the x-locations are available.

Relatively (0 ... 1)

If the check box *Relatively (0 ... 1)* is selected, the support points can be defined by relative-input. The positions of the intermediate supports are determined from the member length and the relative distances from the member start. When the check box *Relatively (0 ... 1)* is cleared, you can define the distances manually in the upper table.



In case of cantilevers, avoid intermediate restraints because such supports divide the member into segments. For cantilevered beams, this would result in segments with torsional restraints on one end each that are statically underdetermined.

2.5 Effective Lengths - Members

Window 1.5 consists of two parts. In table in the upper part provides summarized information on the effective length coefficients μ_y and μ_z , the effective lengths $\mu_y l$ and $\mu_z l$, the effective lengths l_{ef} for lateral-torsional buckling and the beam type of the members to be designed. The effective lengths defined in RFEM are preset. In the *Settings* section, further information is shown about the member whose row is selected in the upper section.

Click the button [↖] to select a member graphically and to show its row.

Changes can be made in the table as well as in the *Settings* tree.



1.5 Effective Lengths - Members

Member No.	Buckling Possible	Buckling About Major Axis (y)		Buckling About Minor Axis (z)		Lateral-Torsional Buckling			Comment	
		Possible	μ_y	$\mu_y l$ [m]	Possible	μ_z	$\mu_z l$ [m]	Possible	Beam Type	l_{ef} [m]
1	<input checked="" type="checkbox"/>	<input checked="" type="checkbox"/>	1.000	6.000	<input checked="" type="checkbox"/>	1.000	3.000	<input checked="" type="checkbox"/>	Beam	3.000
2	<input checked="" type="checkbox"/>	<input checked="" type="checkbox"/>	1.000	6.000	<input checked="" type="checkbox"/>	1.000	6.000	<input checked="" type="checkbox"/>	Beam	6.000
3	<input checked="" type="checkbox"/>	<input checked="" type="checkbox"/>	1.000	3.011	<input checked="" type="checkbox"/>	1.000	1.004	<input checked="" type="checkbox"/>	Beam	1.004
4	<input checked="" type="checkbox"/>	<input checked="" type="checkbox"/>	1.000	3.262	<input checked="" type="checkbox"/>	1.000	3.262	<input checked="" type="checkbox"/>	Beam	3.262
5	<input checked="" type="checkbox"/>	<input checked="" type="checkbox"/>	1.000	6.274	<input checked="" type="checkbox"/>	1.000	1.255	<input checked="" type="checkbox"/>	Beam	1.255
6	<input checked="" type="checkbox"/>	<input checked="" type="checkbox"/>	1.000	6.274	<input checked="" type="checkbox"/>	1.000	6.274	<input checked="" type="checkbox"/>	Beam	6.274
7	<input checked="" type="checkbox"/>	<input checked="" type="checkbox"/>	1.000	3.262	<input checked="" type="checkbox"/>	1.000	3.262	<input checked="" type="checkbox"/>	Beam	3.262
8	<input checked="" type="checkbox"/>	<input checked="" type="checkbox"/>	1.000	3.011	<input checked="" type="checkbox"/>	1.000	3.011	<input checked="" type="checkbox"/>	Beam	3.011
11	<input checked="" type="checkbox"/>	<input checked="" type="checkbox"/>	1.000	6.000	<input checked="" type="checkbox"/>	1.000	6.000	<input checked="" type="checkbox"/>	Beam	6.000
12	<input checked="" type="checkbox"/>	<input checked="" type="checkbox"/>	1.000	6.000	<input checked="" type="checkbox"/>	1.000	6.000	<input checked="" type="checkbox"/>	Beam	6.000

Settings - Member No. 1

Cross-Section	1 - IP-B 45 B1 GOST, 1994		
Length	l	6.000	m
Buckling Possible		<input checked="" type="checkbox"/>	
<input type="checkbox"/> Buckling About Axis y Possible		<input checked="" type="checkbox"/>	
Effective Length Coefficient	μ_y	1.000	
Effective Length	$\mu_y l$	6.000	m
<input type="checkbox"/> Buckling About Axis z Possible		<input checked="" type="checkbox"/>	
Effective Length Coefficient	μ_z	1.000	
Effective Length	$\mu_z l$	3.000	m
<input type="checkbox"/> Lateral-Torsional Buckling Possible		<input checked="" type="checkbox"/>	
Beam type		Beam	
LTB Length	l_{ef}	3.000	m
Comment			

IP-B 45 B1 | GOST, 1994

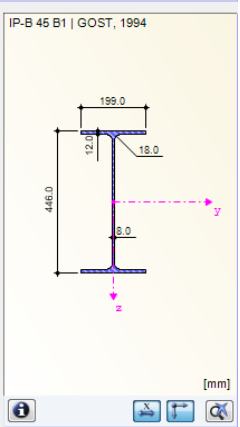

Figure 2.13: Window 1.5 *Effective Lengths - Members*

The effective lengths for the column buckling about the minor axis z and the effective lengths for lateral-torsional buckling are aligned automatically with the entries of window 1.4 *Intermediate Lateral Restraints*. If intermediate restraints divide the member into member segments of different lengths, the program displays no values in the table columns G and J of window 1.5.

The effective lengths can be entered manually in the table and in the *Settings* tree, or defined graphically in the work window after clicking [...]. This button is enabled when you click in the input field.

The *Settings* tree manages the following parameters:

- *Cross-section*
- *Length* (actual length of the member)
- *Buckling Possible* (cf column A)
- *Buckling About Major Axis y Possible* (buckling lengths, cf columns B - D)
- *Buckling About Minor Axis z Possible* (buckling lengths, cf columns E - G)
- *Lateral-Torsional Buckling Possible* (cf column H)
- *Beam Type* (cf column I)
- *Lateral-Torsional Buckling Length* (cf column J)

In this table, you can specify for the currently selected member whether to carry out a buckling or a lateral-torsional buckling analysis. In addition to this, you can adjust the *Effective Length Factor* for the respective lengths. When a coefficient is modified, the equivalent member length is adjusted automatically, and vice versa.



You can also define the buckling length of a member in a dialog box. To open it, click the button shown on the left. It is located on the right below the upper table of the window.

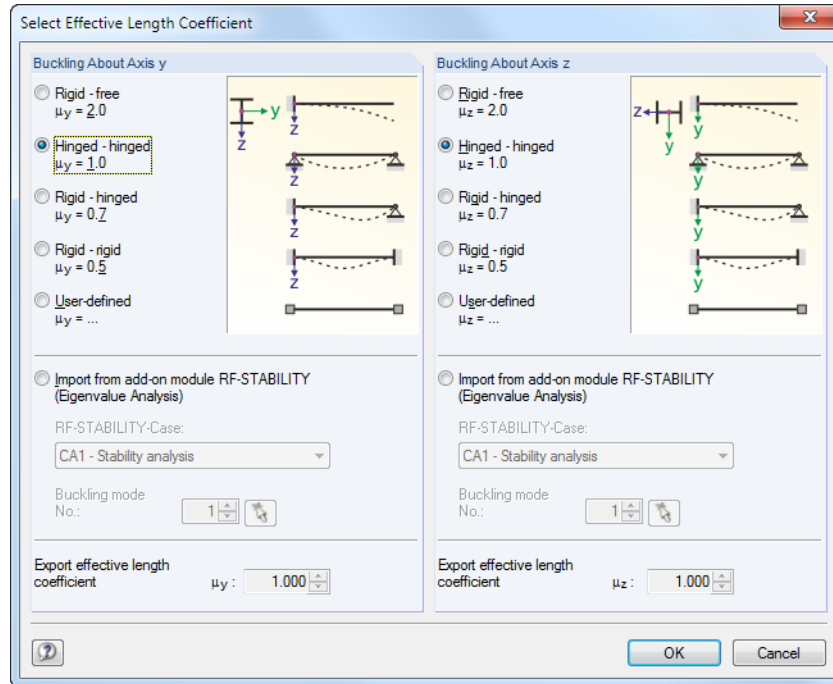

Figure 2.14: Dialog box *Select Effective Length Coefficient*

In this dialog box, the values of the coefficient μ can be defined that are to be assigned to the selected member(s). The μ coefficients are described in detail in [1], clause 10.3 – Effective lengths of columns (page 240). Generally, it is possible to select predefined coefficients or to enter *User-defined* values.

If a RF-STABILITY case calculated according to the eigenvalue analysis is already available, you can also select a *Buckling mode* to determine the factor.

Buckling Possible

A stability analysis for buckling and lateral buckling requires the ability of members to absorb compressive forces. Therefore, members for which such absorption is not possible because of the member type (for example tension members, elastic foundations, rigid connections) are excluded from design in the first place. The corresponding rows appear dimmed and a note is indicated in the *Comment* column.

The *Buckling Possible* check boxes in table row A enable and in the *Settings* tree enable you to classify specific members as compression members or, alternatively, to exclude them from the design according to [1].

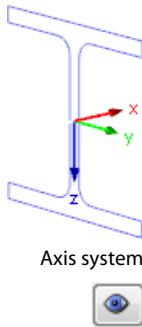

Axis system

Buckling About Axis y or Axis z

With the check boxes in the *Possible* table columns, you decide whether a member is susceptible to buckling about the y-axis and/or z-axis. These axes represent the local member axes, with axis y being the "major" and axis z the "minor" member axis. The effective length coefficients μ_y and μ_z for buckling about the major or the minor axes can be selected freely.

You can check the position of the member axes in the cross-section graphic in window 1.3 *Cross-Sections* (see Figure 2.8, page 14). To access the RFEM work window, click [View mode]. In the work window, you can display the local member axes by using the member's context menu or the *Display* navigator.

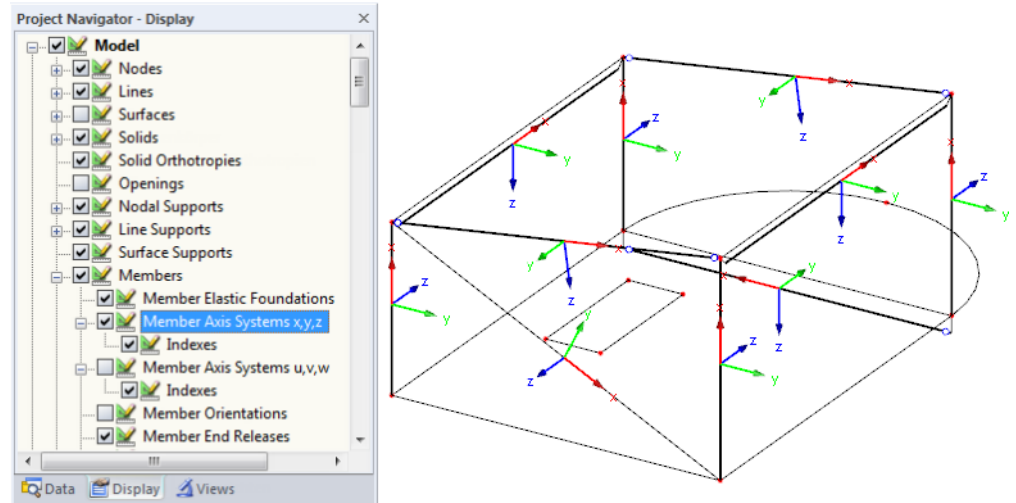

Figure 2.15: Displaying the member axes in the *Display* navigator of RFEM

If buckling is possible about one or even both member axes, you can enter the buckling length coefficients as well as the buckling lengths in the columns C and D respectively F and G. The same is possible in the *Settings* tree.



To specify the buckling lengths in the work window graphically, click [...]. This button becomes available when you click in a μl input field.

When you define the effective length coefficient μ , the program determines the effective length μl by multiplying the member length l by this buckling length coefficient.

Lateral-Torsional Buckling

Table column H controls whether a lateral torsional buckling design is to be carried out.

Column I provides two options to allocate the *Beam Type* according to [1] Annex G, Tables G.1 and G.2.

The lateral-torsional buckling lengths l_{cr} depend on the settings of window 1.4 *Intermediate Lateral Restraints*. There is also a possibility to insert a user-defined value into the column J.

Comment

In the last table column, you can enter your own comments for each member to describe, for example, the effective member lengths.



Below the *Settings* table, you find the *Set input for members No.* check box. If selected, the settings entered afterwards will be applied to the selected or to *All* members. Members can be selected by typing the member number or by selecting them graphically using the [^] button. This option is useful when you want to assign the same boundary conditions to several members. Please note that already defined settings cannot be changed subsequently with this function.

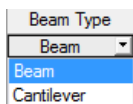

2.6 Effective Lengths - Sets of Members

The input window 1.6 controls the effective lengths for sets of members. It is only available if one or more sets of members have been selected in window 1.1 *General Data*.

1.6 Effective Lengths - Sets of Members

Set No.	A	B	C		D		E		F		G		H	I	J	K
	Buckling Possible	Buckling About Major Axis Possible	μ_y	μ_y [m]	Buckling About Minor Axis Possible	μ_z	μ_z [m]						Lateral-Torsional Buckling Possible	Beam Type	l_{ef} [m]	Comment
2	<input checked="" type="checkbox"/>	<input checked="" type="checkbox"/>	1.000	6.000	<input checked="" type="checkbox"/>	1.000	3.000						<input checked="" type="checkbox"/>	Beam	3.000	

Settings - Set of Members No. 2

<input type="checkbox"/> Set of Members	Set No. 2
<input type="checkbox"/> Cross-Section	1 - IP-B 45 B1 GOST, 1994
Length	6.000 m
<input type="checkbox"/> Buckling Possible	<input checked="" type="checkbox"/>
<input type="checkbox"/> Buckling About Axis y Possible	<input checked="" type="checkbox"/>
Effective Length Coefficient	μ_y 1.000
Effective Length	μ_y 6.000 m
<input type="checkbox"/> Buckling About Axis z Possible	<input checked="" type="checkbox"/>
Effective Length Coefficient	μ_z 1.000
Effective Length	μ_z 3.000 m
<input type="checkbox"/> Lateral-Torsional Buckling Possible	<input checked="" type="checkbox"/>
Beam type	Beam
LTB Length	l_{ef} 3.000 m
Comment	

Set input for sets No.: All

IP-B 45 B1 | GOST, 1994

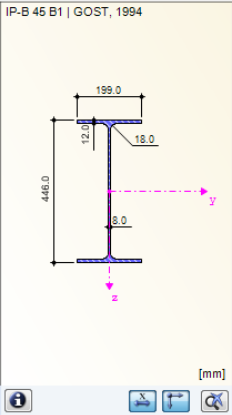

[mm]

Figure 2.16: Window 1.6 *Effective Lengths - Set of Members*

The concept of this window is similar to the one in the previous 1.5 *Effective Lengths - Members* window. In this window, you can enter the effective lengths of the set of members for buckling and lateral-torsional buckling as described in chapter 2.5.

2.7 Serviceability Data

This input window controls several settings for the serviceability limit state design. It is only available if you have set the according entries in the *Serviceability Limit State* tab of window 1.1 *General Data* (see Figure 2.4, page 11).

1.7 Serviceability Data

No.	A Reference to	B Members No.	C Reference Length Manually	D Length L [m]	E Direc- tion	F Precamber w _c [mm]	G Beam Type	H Comment
1	Member	4	<input type="checkbox"/>	3.262	y, z	0.0	Beam	
2	Member	13	<input type="checkbox"/>	3.011	y, z	0.0	Beam	
3	Member	14	<input type="checkbox"/>	3.262	y, z	0.0	Beam	
4	Member	23	<input type="checkbox"/>	3.011	y, z	0.0	Beam	
5	List of Members	3-5	<input type="checkbox"/>	12.548	y, z	0.0	Beam	
6	Set of Members	2	<input type="checkbox"/>	6.000	y, z	0.0	Beam	
7								
8								
9								
10								
11								
12								
13								
14								
15								
16								
17								
18								
19								
20								
21								
22								
23								
24								
25								
26								
27								
28								
29								
30								
31								
32								

Figure 2.17: Window 1.7 *Serviceability Data*

In column A, you decide whether you want to apply the deformation to single members, lists of members, or sets of members.

In table column B, you enter the numbers of the members or sets of members that you want to design. You can also click [...] to select them graphically in the RFEM work window. Then, the *Reference Length* appears in column D automatically. This column presets the lengths of the members, sets of members, or member lists. If required, you can adjust these values after selecting the *Manually* check box in column C.

Table column E defines the governing *Direction* for the deformation analysis. You can select the directions of the local member axes y and z (or u and v for unsymmetrical cross-sections).

A *precamber* w_c can be taken into account by using entries specified in column F.

The *Beam Type* is of vital importance for the correct application of limit deformations. In table column G, you can select the girder to be a beam or a cantilever and decide which end should have no support.

The settings of the *Details* dialog box determine whether the deformations are related to the undeformed initial model or to the shifted ends of members or sets of members (see Figure 3.1, page 25).

Reference to

Member

Member

List of Members

Set of Members

Direction

y, z

y

z

y, z

Beam Type

Beam

Beam

Cantilever Start Free

Cantilever End Free

Details...

2.8 Parameters - Members

The last input window controls additional design parameters for members.

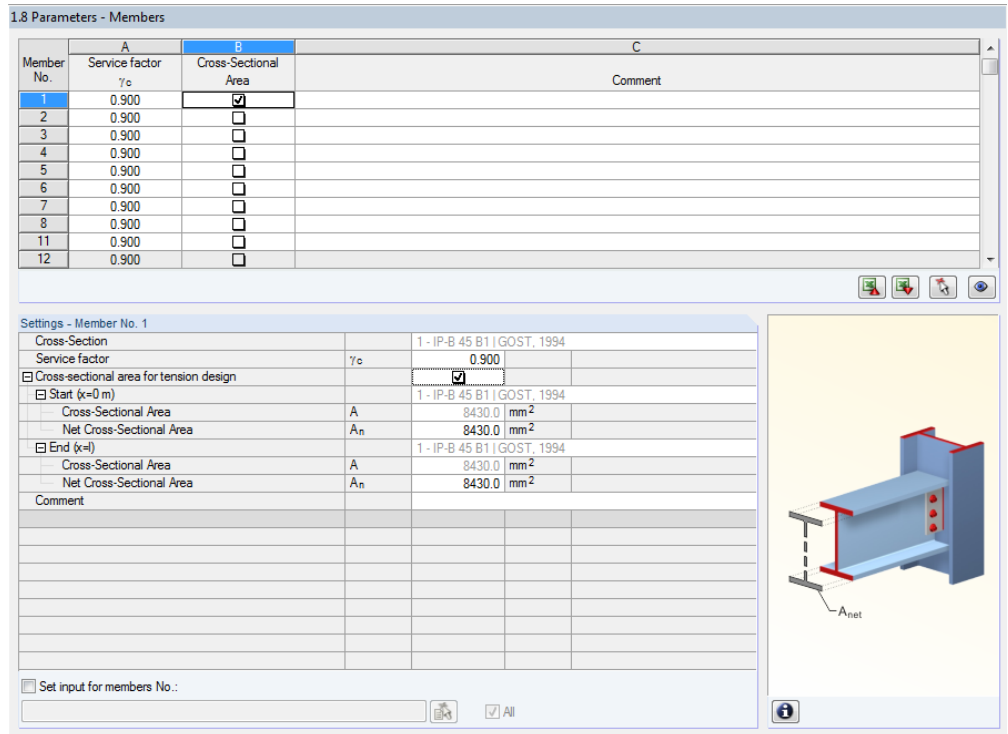

Figure 2.18: Window 1.8 Parameters - Members

Service Factor

In column A, there is the possibility to set a value of service factor according to [1] Table 1. The value is set as 0.9 by default. However, it is important to check the structural member and to correct this value if appropriate.

Cross-Sectional Area

Column B provides an option to reduce the cross-sectional area of the selected member. The values of reduced net cross-sectional areas are related to the start and end of the members.

3. Calculation

3.1 Details

Calculation

Details...

Before you start the [Calculation], it is recommended to check the design details. You can open the corresponding dialog box in all windows of the add-on module by clicking [Details].

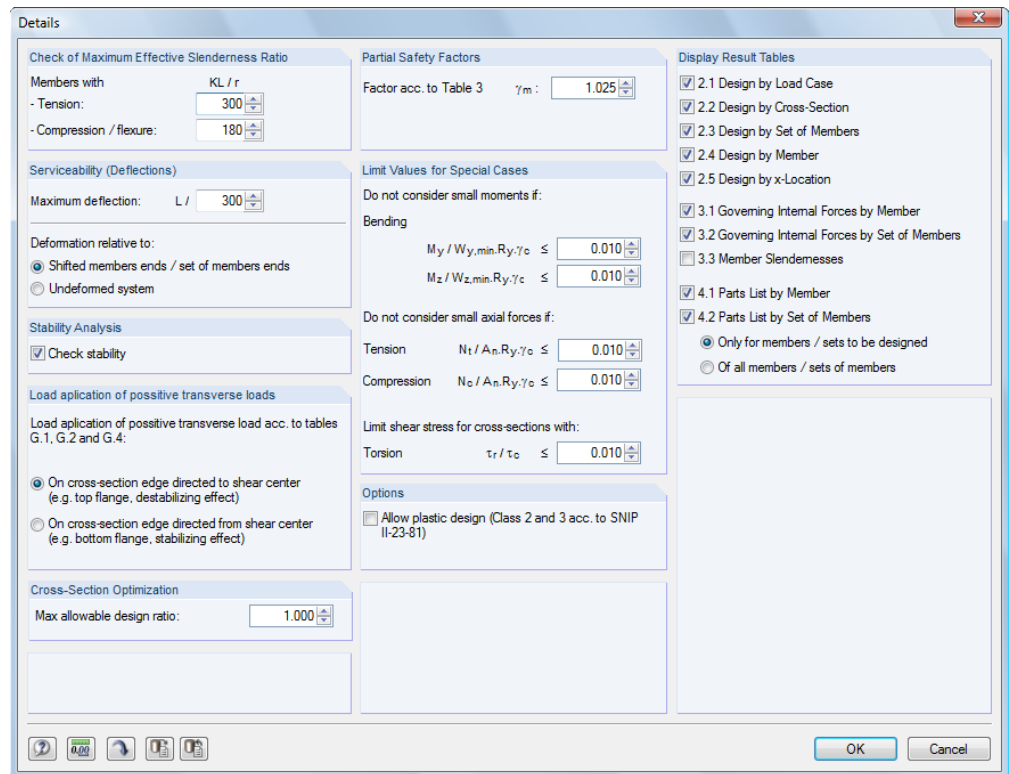

Figure 3.1: Dialog box *Details*

Check of Maximum Effective Slenderness Ratio

In the two input fields, you can specify the limit values $K \cdot L / r$ of the slenderness ratios. It is possible to enter specifications separately for members with pure tension forces and members with bending and compression.

The real member slendernesses are compared to the limit values in window 3.3. This window is available after the calculation (see chapter 4.8, page 35) if the corresponding check box is selected in the dialog section *Display Result Tables*.

This check does not apply to the member types "Tension" and "Cable" because they are excluded from this check.

Serviceability (Deflections)

In this section, it is possible to change set the allowable deflection for the serviceability limit state design if the default value $L/300$ is not appropriate.

The two option fields below control whether the *Deformation* is to be related to the shifted ends of members or sets of members (connection line between start and end nodes of the deformed system) or to the undeformed initial system. As a rule, the deformations have to be checked relative to the displacements in the entire structural system.

Stability Analysis

When ticking the check box in this dialog section, you decide if you want to perform a *Stability Analysis* generally. If you clear the check box, the input windows 1.4 to 1.7 won't be displayed.

Load application of positive transverse loads

Usually, loads act on members (transverse loads). It is important to define where these forces are acting on the cross-section: Depending on the *Load Application* point, transverse loads can be stabilizing or destabilizing, and in this way they can decisively influence the lateral torsional buckling design.

Cross-Section Optimization

The optimization is targeted on the maximum design ratio of 100 %. If necessary, you can specify a different limit value in this input field.

Partial Safety Factors

In this section, you can change partial safety factor γ_m according to [1] Table 3. The most common value is set as default for this factor.

Limit Values for Special Cases

It is possible to neglect small stresses due to *Bending*, *Tension*, *Compression* or *Torsion* and, thus, allow a simplified design which eliminates negligible internal forces. In this dialog section, the limits of the different types of stresses can be defined. Those are the ratios between the existing stresses and the corresponding resistances of each cross-section.



These limit settings are not part of the code [1]. Changing the limits is in the responsibility of the program user.

Options

All cross-sections are automatically classified as Class 1 so that there is an elastic design. Alternatively, you can activate the *Plastic Design* for all cross-sections.

Display Result Tables

In this dialog section, you can select the results windows including parts list that you want to be displayed. The windows are described in chapter 4 *Results*.

The 3.3 *Member Slendernesses* window is inactive by default.

3.2 Start Calculation

Calculation

To start the calculation, click the [Calculation] button that is available in all input windows of the RF-STEEL SP add-on module.

RF-STEEL SP searches for the results of the load cases, load and result combinations to be designed. If these cannot be found, the program starts the RFEM calculation to determine the design relevant internal forces.

You can also start the calculation in the RFEM user interface: In the dialog box *To Calculate* (menu *Calculate* → *To Calculate*), design cases of the add-on modules like load cases and load combinations are listed.

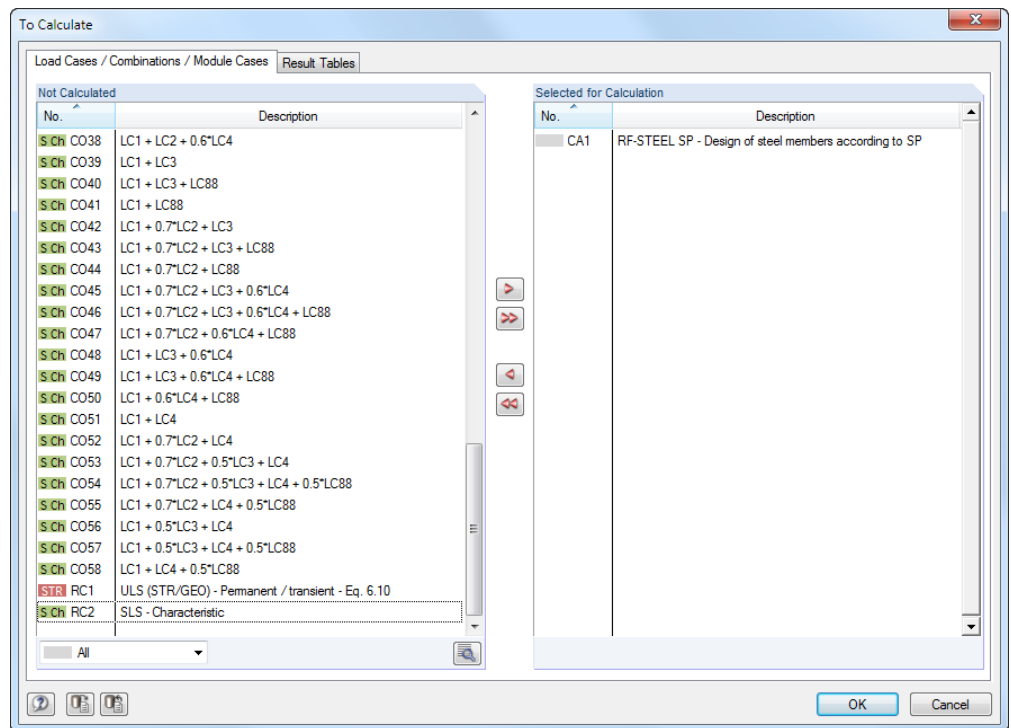
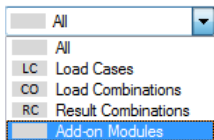

Figure 3.2: *To Calculate* Dialog box

If the RF-STEEL SP design cases are missing in the *Not Calculated* list, select *All* or *Add-on Modules* in the drop-down list at the end of the list.



To transfer the selected RF-STEEL SP cases to the list on the right, use the button [▶]. Click [OK] to start the calculation.



To calculate a design case directly, use the list in the toolbar. Select the RF-STEEL SP design case in the toolbar list, and then click [Show Results].



Figure 3.3: Direct calculation of a RF-STEEL SP design case in RFEM

Subsequently, you can observe the design process in a separate dialog box.

4. Results

Window 2.1 *Design by Load Case* is displayed immediately after the calculation.

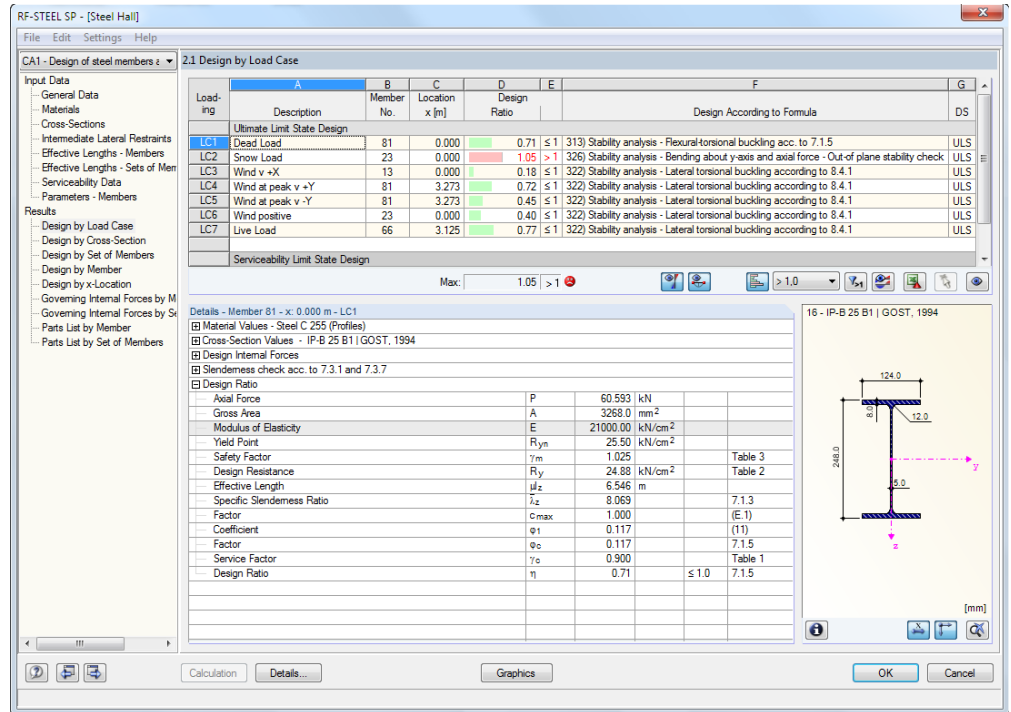

Figure 4.1: Results window with designs and intermediate values

The designs are shown in the results windows 2.1 to 2.5, sorted by different criteria.

The windows 3.1 and 3.2 list the governing internal forces. Window 3.3 informs you about the member slendernesses. The last two results windows 4.1 and 4.2 show the parts lists sorted by member and set of members.

Every window can be selected by clicking the corresponding entry in the navigator. To set the previous or next input window, use the buttons shown on the left. You can also use the function keys to select the next [F2] or previous [F3] window.

Click [OK] to save the results. Thus you exit RF-STEEL SP and return to the main program.

Chapter 4 *Results* describes the different results windows one by one. Evaluating and checking results is described in chapter 5 *Results Evaluation*, page 38.

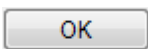

4.1 Design by Load Case



The upper part of this window provides a summary, sorted by load cases, load combinations, and result combinations of the governing designs. Furthermore, the list is divided in *Ultimate Limit State Design* and *Serviceability Limit State Design* results.

The lower part gives detailed information on the cross-section properties, analyzed internal forces, and design parameters for the load case selected above.

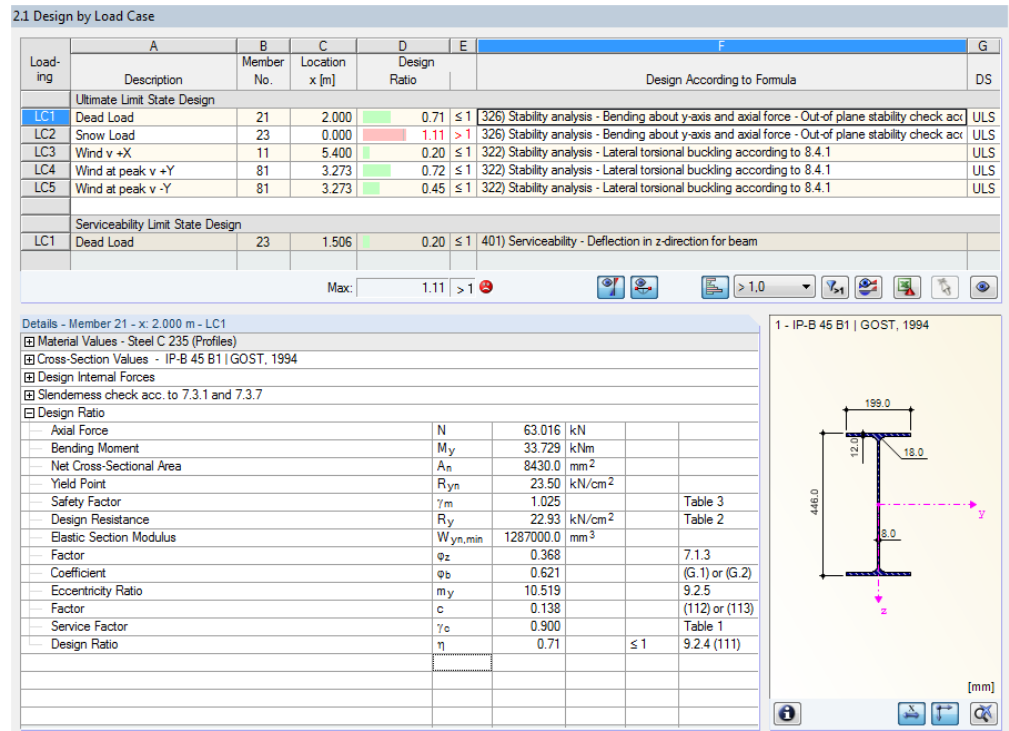

Figure 4.2: Window 2.1 Design by Load Case

Description

This column shows the descriptions of the load cases, load and result combinations used for the design.

Member No.

This column shows the number of the member that bears the maximum stress ratio of the designed loading.

Location x

This column shows the respective x-location where the member's maximum stress ratio occurs. For the table output, the program uses the following member locations x:

- Start and end node
- Division points according to possibly defined member division (see RFEM table 1.16)
- Member division according to specification for member results (RFEM dialog box *Calculation Parameters*, tab *Global Calculation Parameters*)
- Extreme values of internal forces

Design Ratio

Columns D and E display the design conditions according to SP 16.13330.2011 [1].

The lengths of the colored bars represent the respective utilizations.

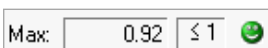

Design according to Formula

This column lists the code's equations by which the designs have been performed.

DS

The final column provides information on the respective design-relevant design situation (DS): ULS (Ultimate Limit State) or SLS (Serviceability Limit State).

4.2 Design by Cross-Section

2.2 Design by Cross-Section

Section No.	A Member No.	B Location x [m]	C Load Case	D Design Ratio	E	F Design According to Formula
1	IP-B 45 B1 GOST, 1994					
	39	3.000	LC4	0.01	≤ 1	100) Negligible internal forces
	31	0.000	LC1	0.06	≤ 1	102) Cross-section check - Compression acc. to 7.1.1
	2	6.000	LC4	0.01	≤ 1	106) Cross-section check - Shear force in y-axis acc. to 8.2.3
	32	0.000	LC2	0.21	≤ 1	108) Cross-section check - Shear force in z-axis acc. to 8.2.3
	21	6.000	LC2	0.64	≤ 1	111) Cross-section check - Bending about y-axis acc. to 8.2.1 - Class 1
	1	3.000	LC4	0.17	≤ 1	116) Cross-section check - Bending about z-axis acc. to 8.2.1 - Class 1
	21	6.000	LC2	0.56	≤ 1	139) Cross-section check - Bending about y- and/or z-axis acc. to 8.2.1
	21	6.000	LC2	0.59	≤ 1	181) Cross-section check - Biaxial bending about y-axis, shear and axial force acc. to 9.1.1
	31	0.000	LC1	0.06	≤ 1	301) Stability analysis - Flexural buckling about y-axis acc. to 7.1.3

Max: 1.11 > 1

Details - Member 2 - x: 6.000 m - LC4

- Material Values - Steel C 235 (Profiles)
- Cross-Section Values - IP-B 45 B1 | GOST, 1994
- Design Internal Forces
- Slenderness check acc. to 7.3.1 and 7.3.7
- Design Ratio

Shear Force	Q _y	3.752	kN		
Statical Moment	S _z	59401.5	mm ³		
Moment of Inertia	I _z	15797000.0	mm ⁴		
Thickness of Flange	t _f	12.0	mm		
Yield Point	R _{yn}	23.50	kN/cm ²		
Safety Factor	γ _m	1.025			Table 3
Design Resistance	R _s	13.30	kN/cm ²		Table 2
Service Factor	γ _c	0.900			Table 1
Design Ratio	η	0.01		≤ 1	8.2.1 (42)

Figure 4.3: Window 2.2 Design by Cross-Section

This window lists the maximum ratios of all members and actions selected for design, sorted by cross-section. The results are sorted by cross-section design and serviceability limit state design.

If there is a tapered member, both cross-section descriptions are displayed in the table row next to the section number.

4.3 Design by Set of Members

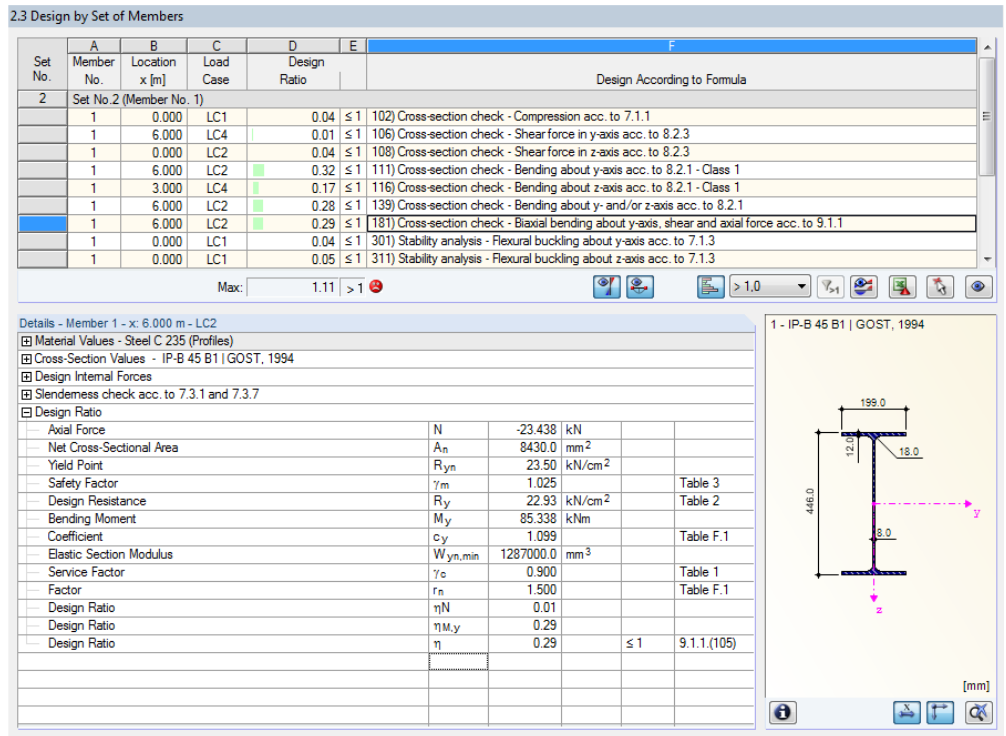

Figure 4.4: Window 2.3 Design by Set of Members

This results window is displayed if you have selected at least one set of members for design. The window lists the maximum ratios sorted by set of members.

The *Member No.* column shows the number of the one member within the set of members that bears the maximum ratio for the individual design criteria.

The output by set of members clearly presents the design for an entire structural group (for example a frame).

4.4 Design by Member

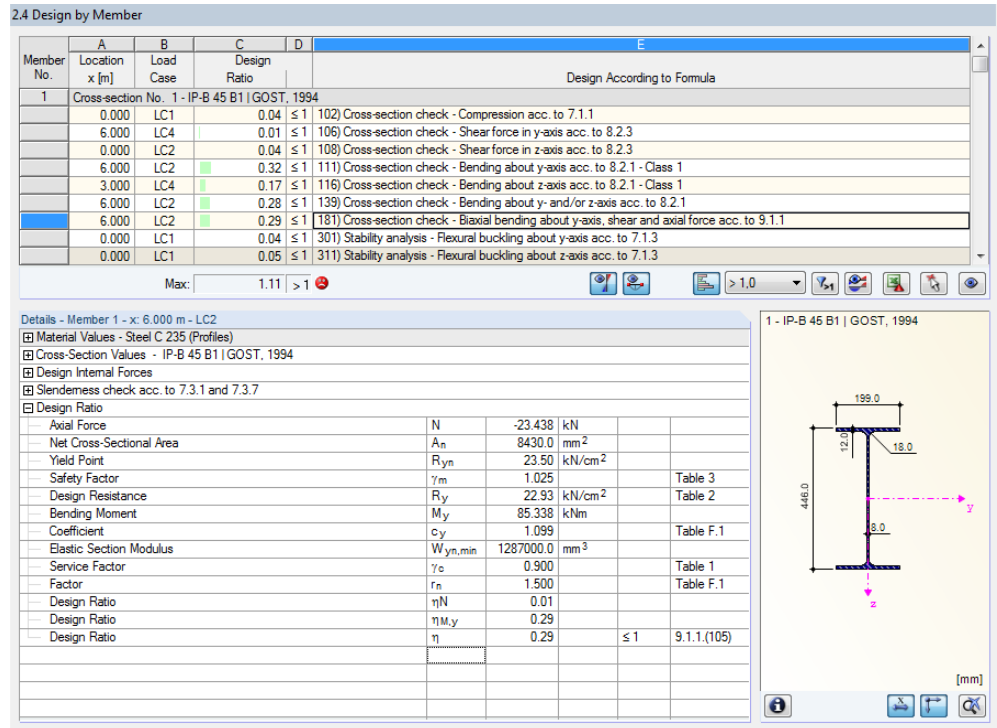

Figure 4.5: Window 2.4 Design by Member

This results window presents the maximum ratios for the individual designs sorted by member number. The columns are described in detail in chapter 4.1 on page 29.

4.5 Design by x-Location

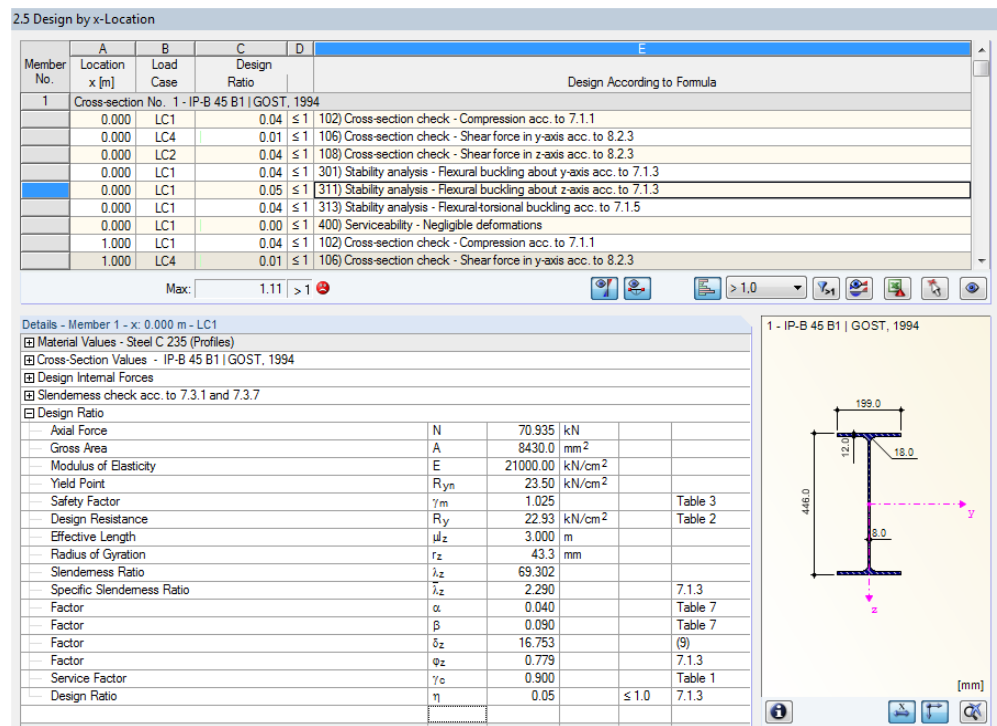

Figure 4.6: Window 2.5 Design by x-Location

This results window lists the maxima for each member at the locations *x* resulting from the division points defined in RFEM:

- Start and end node
- Division points according to possibly defined member division (see RFEM table 1.16)
- Member division according to specification for member results (RFEM dialog box *Calculation Parameters*, tab *Global Calculation Parameters*)
- Extreme values of internal forces

4.6 Governing Internal Forces by Member

3.1 Governing Internal Forces by Member

Member No.	A Location x [m]	B Load- ing	C Forces [kN]			E Moments [kNm]			I Design According to Formula
			N	V _y	V _z	M _x	M _y	M _z	
1	Cross-section No. 1 - IP-B 45 B1 GOST, 1994								
	0.000	LC1	-70.935	0.000	-10.283	0.001	0.000	0.000	102) Cross-section check - Compression acc. to 7.1.1
	6.000	LC4	0.000	3.752	0.000	0.010	0.000	-0.011	106) Cross-section check - Shear force in y-axis acc. to 8.2.3
	0.000	LC2	-23.438	0.000	-14.223	0.000	0.000	0.000	108) Cross-section check - Shear force in z-axis acc. to 8.2.3
	6.000	LC2	-23.438	0.000	-14.223	0.000	-85.338	0.000	111) Cross-section check - Bending about y-axis acc. to 8.2.1 -
	3.000	LC4	0.000	0.002	0.000	0.010	0.000	5.620	116) Cross-section check - Bending about z-axis acc. to 8.2.1 -
	6.000	LC2	-23.438	0.000	-14.223	0.000	-85.338	0.000	139) Cross-section check - Bending about y- and/or z-axis acc.
	6.000	LC2	-23.438	0.000	-14.223	0.000	-85.338	0.000	181) Cross-section check - Biaxial bending about y-axis, shear i
	0.000	LC1	-70.935	0.000	-10.283	0.001	0.000	0.000	301) Stability analysis - Flexural buckling about y-axis acc. to 7.
	0.000	LC1	-70.935	0.000	-10.283	0.001	0.000	0.000	311) Stability analysis - Flexural buckling about z-axis acc. to 7.
	6.000	LC2	-23.438	0.000	-14.223	0.000	-85.338	0.000	313) Stability analysis - Flexural-torsional buckling acc. to 7.1.5
	6.000	LC1	-16.996	0.000	-10.283	0.001	61.698	0.000	322) Stability analysis - Lateral torsional buckling according to 8
	6.000	LC2	-23.438	0.000	-14.223	0.000	-85.338	0.000	324) Stability analysis - Bending about y-axis and axial force - In
	4.000	LC2	-23.438	0.000	-14.223	0.000	-56.892	0.000	326) Stability analysis - Bending about y-axis and axial force - O
	0.000	LC1	0.000	0.000	0.000	0.000	0.000	0.000	400) Serviceability - Negligible deformations
	3.000	LC1	0.000	0.000	0.000	0.000	0.000	0.000	401) Serviceability - Deflection in z-direction for beam
2	Cross-section No. 1 - IP-B 45 B1 GOST, 1994								
	0.000	LC1	-70.935	0.000	10.283	0.000	0.000	0.000	102) Cross-section check - Compression acc. to 7.1.1
	6.000	LC4	0.000	3.752	0.000	-0.010	0.000	-0.011	106) Cross-section check - Shear force in y-axis acc. to 8.2.3
	0.000	LC2	-23.438	0.000	14.223	0.000	0.000	0.000	108) Cross-section check - Shear force in z-axis acc. to 8.2.3
	6.000	LC2	-23.438	0.000	14.223	0.000	85.338	0.000	111) Cross-section check - Bending about y-axis acc. to 8.2.1 -
	3.000	LC4	0.000	0.002	0.000	-0.010	0.000	5.620	116) Cross-section check - Bending about z-axis acc. to 8.2.1 -
	6.000	LC2	-23.438	0.000	14.223	0.000	85.338	0.000	139) Cross-section check - Bending about y- and/or z-axis acc.
	6.000	LC2	-23.438	0.000	14.223	0.000	85.338	0.000	181) Cross-section check - Biaxial bending about y-axis, shear i
	0.000	LC1	-70.935	0.000	10.283	0.000	0.000	0.000	301) Stability analysis - Flexural buckling about y-axis acc. to 7.
	0.000	LC1	-70.935	0.000	10.283	0.000	0.000	0.000	311) Stability analysis - Flexural buckling about z-axis acc. to 7.
	6.000	LC2	-23.438	0.000	14.223	0.000	85.338	0.000	313) Stability analysis - Flexural-torsional buckling acc. to 7.1.5
	6.000	LC1	-16.996	0.000	10.283	0.000	61.698	0.000	322) Stability analysis - Lateral torsional buckling according to 8
	6.000	LC2	-23.438	0.000	14.223	0.000	85.338	0.000	324) Stability analysis - Bending about y-axis and axial force - In
	1.000	LC2	-23.438	0.000	14.223	0.000	14.223	0.000	326) Stability analysis - Bending about y-axis and axial force - O
3	Cross-section No. 3 - IP 40 B1 GOST 26020-83 ... 2 - IP-B 40 B1 GOST, 1994								
	0.000	LC4	0.000	-0.056	0.000	-0.010	0.000	-0.011	100) Negligible internal forces

Figure 4.7: Window 3.1 *Governing Internal Forces by Member*

For each member, this window displays the governing internal forces, i.e. those internal forces that result in the maximum utilization of each design.

Location *x*

At this *x* location of the member, the respective maximum design ratio occurs.

Load Case

This column displays the number of the load case, the load combination or result combination whose internal forces result in the maximum design ratios.

Forces / Moments

For each member, this column displays the axial and shear forces as well as the torsional and bending moments producing maximum design ratios in the respective ultimate limit state and serviceability limit state designs.

Design According to Formula

The final column provides information on the types of design and the equations by which the designs according to [1] have been performed.

4.7 Governing Internal Forces by Set of Members

3.2 Governing Internal Forces by Set of Members

Set No.	A Location x [m]	B Load- ing	D Forces [kN]			G Moments [kNm]			I Design According to Formula
			C N	V _y	V _z	F M _x	M _y	M _z	
2	Set No.2 (Member No. 1)								
	0.000	LC1	-70.935	0.000	-10.283	0.001	0.000	0.000	102) Cross-section check - Compression acc. to 7.1.1
	6.000	LC4	0.000	3.752	0.000	0.010	0.000	-0.011	106) Cross-section check - Shear force in y-axis acc. to 8.2.3
	0.000	LC2	-23.438	0.000	-14.223	0.000	0.000	0.000	108) Cross-section check - Shear force in z-axis acc. to 8.2.3
	6.000	LC2	-23.438	0.000	-14.223	0.000	-85.338	0.000	111) Cross-section check - Bending about y-axis acc. to 8.2.1 - Cla
	3.000	LC4	0.000	0.002	0.000	0.010	0.000	5.620	116) Cross-section check - Bending about z-axis acc. to 8.2.1 - Cla
	6.000	LC2	-23.438	0.000	-14.223	0.000	-85.338	0.000	139) Cross-section check - Bending about y- and/or z-axis acc. to .
	6.000	LC2	-23.438	0.000	-14.223	0.000	-85.338	0.000	181) Cross-section check - Biaxial bending about y-axis, shear and
	0.000	LC1	-70.935	0.000	-10.283	0.001	0.000	0.000	301) Stability analysis - Flexural buckling about y-axis acc. to 7.1.3
	0.000	LC1	-70.935	0.000	-10.283	0.001	0.000	0.000	311) Stability analysis - Flexural buckling about z-axis acc. to 7.1.3
	6.000	LC2	-23.438	0.000	-14.223	0.000	-85.338	0.000	313) Stability analysis - Flexural-torsional buckling acc. to 7.1.5
	6.000	LC1	-16.996	0.000	-10.283	0.001	-61.698	0.000	322) Stability analysis - Lateral torsional buckling according to 8.4.1
	6.000	LC2	-23.438	0.000	-14.223	0.000	-85.338	0.000	324) Stability analysis - Bending about y-axis and axial force - In pla
	4.000	LC2	-23.438	0.000	-14.223	0.000	-56.892	0.000	326) Stability analysis - Bending about y-axis and axial force - Out-o
	0.000	LC1	0.000	0.000	0.000	0.000	0.000	0.000	400) Serviceability - Negligible deformations
	3.000	LC1	0.000	0.000	0.000	0.000	0.000	0.000	401) Serviceability - Deflection in z-direction for beam

Figure 4.8: Window 3.2 Governing Internal Forces by Set of Members

This window shows the internal forces that result in the maximum ratios of the design for each set of members.

4.8 Member Slendernesses

3.3 Member Slendernesses

Member No.	A Under Stress	B Length L [m]	C k_y [-]	D Major Axis y i_y [mm]	E λ_y [-]	F k_z [-]	G Minor Axis z i_z [mm]	H λ_z [-]	I
1	Compression / Flexure	6.000	1.000	184.5	32.519	0.500	43.3	69.302	
2	Compression / Flexure	6.000	1.000	184.5	32.519	1.000	43.3	138.605	
3	Compression / Flexure	3.011	1.000	160.4	18.779	0.333	34.2	29.381	
4	Compression / Flexure	3.262	1.000	166.6	19.587	1.000	44.8	72.858	
5	Compression / Flexure	6.274	1.000	166.6	37.667	0.200	44.8	28.022	
6	Compression / Flexure	6.274	1.000	166.6	37.667	1.000	44.8	140.111	
7	Compression / Flexure	3.262	1.000	166.6	19.587	1.000	44.8	72.858	
8	Compression / Flexure	3.011	1.000	160.4	18.779	1.000	34.2	88.143	
11	Compression / Flexure	6.000	1.000	184.5	32.519	1.000	43.3	138.605	
12	Compression / Flexure	6.000	1.000	184.5	32.519	1.000	43.3	138.605	
13	Compression / Flexure	3.011	1.000	160.4	18.779	1.000	34.2	88.143	
14	Compression / Flexure	3.262	1.000	166.6	19.587	1.000	44.8	72.858	
15	Compression / Flexure	6.274	1.000	166.6	37.667	1.000	44.8	140.111	
16	Compression / Flexure	6.274	1.000	166.6	37.667	1.000	44.8	140.111	
17	Compression / Flexure	3.262	1.000	166.6	19.587	1.000	44.8	72.858	
18	Compression / Flexure	3.011	1.000	160.4	18.779	1.000	34.2	88.143	
21	Compression / Flexure	6.000	1.000	184.5	32.519	1.000	43.3	138.605	
22	Compression / Flexure	6.000	1.000	184.5	32.519	1.000	43.3	138.605	
23	Compression / Flexure	3.011	1.000	160.4	18.779	1.000	34.2	88.143	
24	Compression / Flexure	3.262	1.000	166.6	19.587	1.000	44.8	72.858	
25	Compression / Flexure	6.274	1.000	166.6	37.667	1.000	44.8	140.111	
26	Compression / Flexure	6.274	1.000	166.6	37.667	1.000	44.8	140.111	
27	Compression / Flexure	3.262	1.000	166.6	19.587	1.000	44.8	72.858	
28	Compression / Flexure	3.011	1.000	160.4	18.779	1.000	34.2	88.143	
31	Compression / Flexure	3.000	1.000	184.5	16.259	1.000	43.3	69.302	
32	Compression / Flexure	3.000	1.000	184.5	16.259	1.000	43.3	69.302	
33	Compression / Flexure	3.000	1.000	85.5	35.107	1.000	49.5	60.625	
34	Compression / Flexure	3.546	1.000	85.5	41.497	1.000	49.5	71.659	
35	Compression / Flexure	3.000	1.000	85.5	35.107	1.000	49.5	60.625	
36	Compression / Flexure	4.094	1.000	85.5	47.910	1.000	49.5	82.734	

Members with compression / flexure:
 Max KL_y / r_y : 191.205 > 180
 Max KL_z / r_z : 234.432 > 180

Figure 4.8: Window 3.3 Member Slendernesses

Details...

Details...

This results window is shown only when you have selected the respective check box in the *Details* dialog box (see Figure 3.1, page 25).

The table lists the effective slendernesses of the designed members for both directions of the principal axes. They were determined depending on the type of load. At the end of the list, you find a comparison with the limit values that have been defined in the *Details* dialog box (see Figure 3.1, page 25).

Members of the member type "Tension" or "Cable" are not included in this table.

This window is displayed only for information. No design of the slendernesses is carried out.

4.9 Parts List by Member

Finally, RF-STEEL SP provides a summary of all cross-sections that are included in the design case.

4.1 Parts List by Member

Part No.	A Cross-Section Description	B Number of Members	C Length [m]	D Total Length [m]	E Surface Area [m ²]	F Volume [m ³]	G Unit Weight [kg/m]	H Weight [kg]	I Total Weight [t]
1	1 - IP-B 45 B1 GOST, 1994	6	6.00	36.00	59.08	0.30	66.18	397.05	2.382
2	2 - IP-B 40 B1 GOST, 1994 ... 3 - IP 40 B1	8	3.01	24.09	35.42	0.16	52.36	157.68	1.261
3	2 - IP-B 40 B1 GOST, 1994	8	3.26	26.10	40.36	0.19	56.65	184.80	1.478
4	2 - IP-B 40 B1 GOST, 1994	8	6.27	50.19	77.62	0.36	56.65	355.39	2.843
5	1 - IP-B 45 B1 GOST, 1994	4	3.00	12.00	19.69	0.10	66.18	198.53	0.794
6	10 - HP 200x54 CAN/CSA-S16-01	3	3.00	9.00	10.89	0.06	53.54	160.61	0.482
7	10 - HP 200x54 CAN/CSA-S16-01	2	3.55	7.09	8.58	0.05	53.54	189.84	0.380
8	10 - HP 200x54 CAN/CSA-S16-01	1	4.09	4.09	4.95	0.03	53.54	219.18	0.219
9	15 - IP-K 25 K2 GOST, 1994	4	3.00	12.00	17.45	0.11	72.36	217.08	0.868
10	6 - IP-K 20 K2 GOST, 1994	3	3.00	9.00	10.46	0.06	49.87	149.61	0.449
11	6 - IP-K 20 K2 GOST, 1994	2	3.55	7.09	8.24	0.05	49.87	176.84	0.354
12	6 - IP-K 20 K2 GOST, 1994	1	4.09	4.09	4.76	0.03	49.87	204.17	0.204
13	7 - IP-K 20 K2 GOST, 1994	4	6.27	25.10	29.15	0.16	49.87	312.88	1.252
14	9 - IP-B 35 B2 GOST, 1994	8	6.25	50.00	68.10	0.32	49.56	309.78	2.478
15	16 - IP-B 25 B1 GOST, 1994	1	6.55	6.55	6.29	0.02	25.65	167.93	0.168
16	6 - IP-K 20 K2 GOST, 1994	1	7.09	7.09	8.24	0.05	49.87	353.79	0.354
17	6 - IP-K 20 K2 GOST, 1994	1	6.55	6.55	7.60	0.04	49.87	326.46	0.326
18	12 - QRO 70x5 GOST 30245-03	25	5.00	125.00	32.85	0.15	9.70	48.51	1.213
19	13 - Circle 24	4	7.81	31.24	2.36	0.01	3.55	27.74	0.111
20	13 - Circle 24	8	8.02	64.18	4.84	0.03	3.55	28.49	0.228
Sum		102		516.46	456.95	2.27			17.845

Figure 4.9: Window 4.1 Parts List by Member

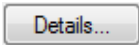

By default, this list contains only the designed members. If you need a parts list for all members of the model, select the corresponding option in the *Details* dialog box (see Figure 3.1, page 25).

Part No.

The program automatically assigns item numbers to similar members.

Cross-Section Description

This column lists the cross-section numbers and descriptions.

Number of Members

This column shows how many similar members are used for each part.

Length

This column displays the respective length of an individual member.

Total Length

This column shows the product determined from the two previous columns.

Surface Area

For each part, the program indicates the surface area related to the total length. The surface area is determined from the *Surface Area* of the cross-sections that can be seen in windows 1.3 and 2.1 to 2.5 in the cross-section information (see Figure 2.10, page 16).



Volume

The volume of a part is determined from the cross-sectional area and the total length.

Unit Weight

The *Unit Weight* of the cross-section is relative to the length of one meter. For tapered cross-sections, the program averages both cross-section masses.

Weight

The values of this column are determined from the respective product of the entries in column C and G.

Total Weight

The final column indicates the total mass of each part.

Sum

At the bottom of the list, you find a sum of the values in the columns B, D, E, F, and I. The last data field of the column *Total Weight* gives information about the total amount of steel required.

4.10 Parts List by Set of Members

4.2 Parts List by Set of Members

Part No.	A Set of Members Description	B Number of Sets	C Length [m]	D Total Length [m]	E Surface Area [m ²]	F Volume [m ³]	G Unit Weight [kg/m]	H Weight [kg]	I Total Weight [t]
1	Set No.2	1	6.00	6.00	9.85	0.05	66.18	397.05	0.397
	Sum	1		6.00	9.85	0.05			0.397

Figure 4.10: Window 4.2 *Parts List by Set of Members*

The last results window is displayed if you have selected at least one set of members for design. The table summarizes an entire structural group (for example a horizontal beam) in a parts list.

Details on the various columns can be found in the previous chapter. If different cross-sections are used in the set of members, the program averages the surface area, the volume, and the cross-section weight.

5. Results Evaluation

The design results can be evaluated in different ways. For this, the buttons in the results windows are very useful which are located below the upper tables.

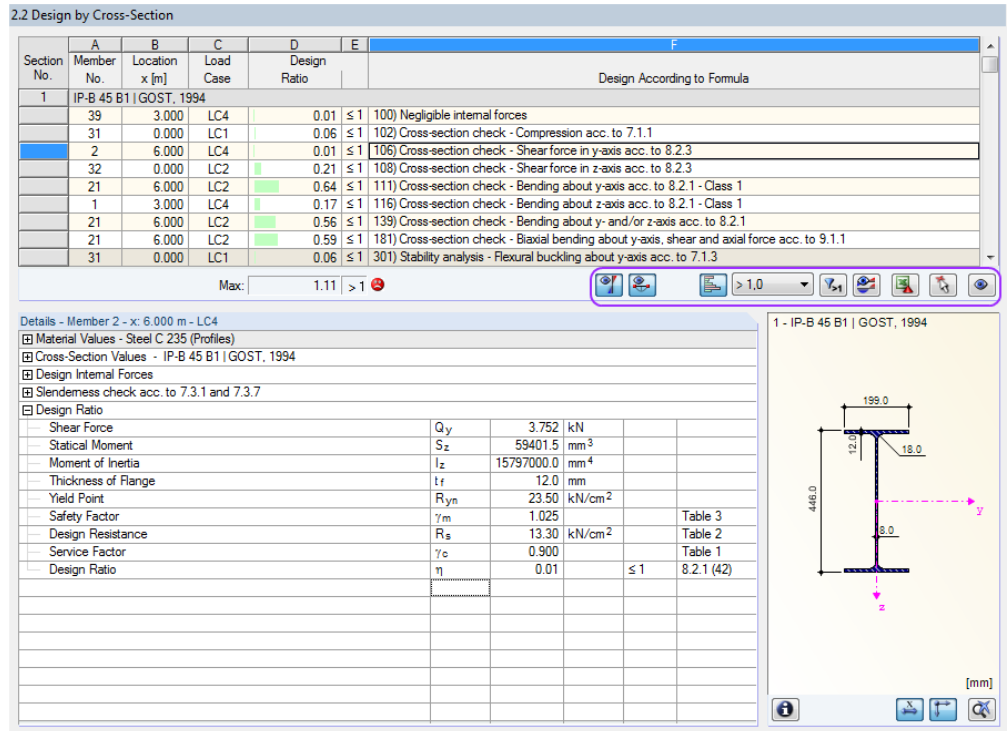

Figure 5.1: Buttons for results evaluation

These buttons have the following functions:

Button	Description	Function
	Ultimate Limit State Designs	Turns on and off the results of the ultimate limit state design
	Serviceability Limit State Designs	Turns on and off the results of the serviceability limit state design
	Show Color Bars	Turns on and off the colored reference scales in the results windows
	Show Rows with Ratio > 1	Displays only the rows where the ratio is greater than 1, and thus the design is failed
	Result Diagrams	Opens the window <i>Result Diagram on Member</i> → chapter 5.2, page 41
	Excel Export	Exports the table to MS Excel / OpenOffice → chapter 7.4.3, page 51
	Member Selection	Allows you to graphically select a member to display its results in the table
	View Mode	Jumps to the RFEM work window to change the view

Table 5.1: Buttons in results windows 2.1 through 2.5

5.1 Results in the RFEM Model

To evaluate the design results, you can also use the RFEM work window.

RFEM background graphic and view mode

The RFEM work window in the background is useful when you want to find the position of a particular member in the model: The member selected in the RF-STEEL SP results window is highlighted in the selection color in the background graphic. Furthermore, an arrow indicates the member's x-location that is displayed in the selected table row.

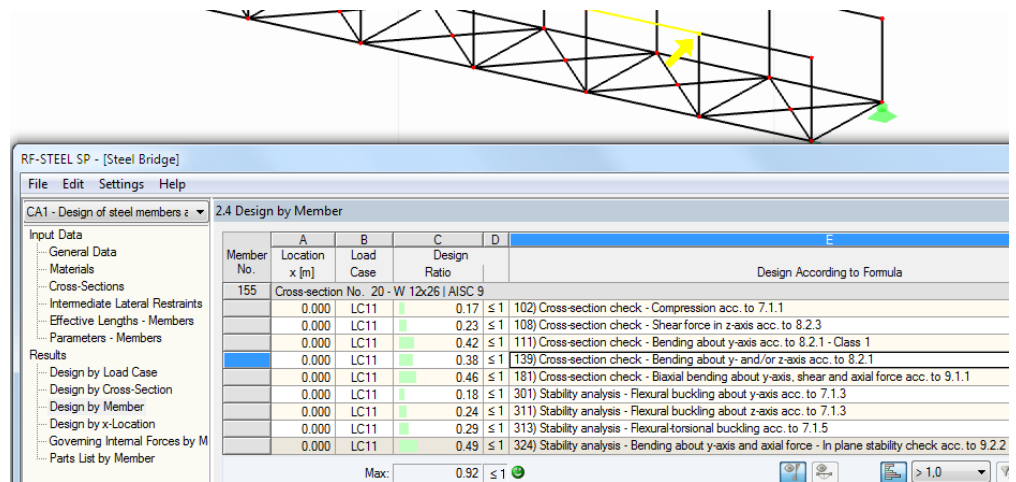

Figure 5.2: Indication of the member and the current Location x in the RFEM model

If you cannot improve the display by moving the RF-STEEL SP module window, click [Jump to Graphic] to activate the View Mode: The program hides the module window so that you can modify the display in the RFEM user interface. The view mode provides the functions of the View menu, for example zooming, moving, or rotating the display. The pointer remains visible.

Click [Back] to return to the add-on module RF-STEEL SP.

RFEM work window

You can also graphically check the design ratios in the RFEM model. Click [Graphics] to exit the design module. In the RFEM work window, the design ratios are now displayed like the internal forces of a load case.

In the Results navigator, you can specify which design ratios of the service or ultimate limit state design you want to display graphically.

To turn the display of design results on or off, use the [Show Results] button known from the display of internal forces in RFEM. To display the result values, use the toolbar button [Show Values] to the right.

As the RFEM tables are of no relevance for the evaluation of design results, you can hide them.

The design cases can be set by means of the list in the RFEM menu bar.

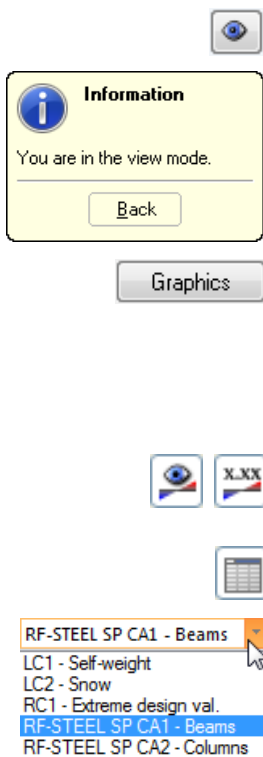

To adjust the graphical representation of the results, you can select *Results* → *Members* in the *Display* navigator. The display of the design ratios is *Two-Colored* by default.

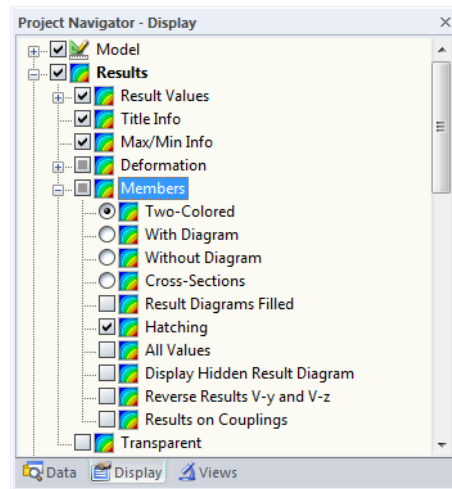

Figure 5.3: *Display* navigator: *Results* → *Members*



When you select a multicolor representation (options *With/Without Diagram* or *Cross-Sections*), the color panel becomes available. It provides the common control functions described in detail in the RFEM manual, chapter 3.4.6.

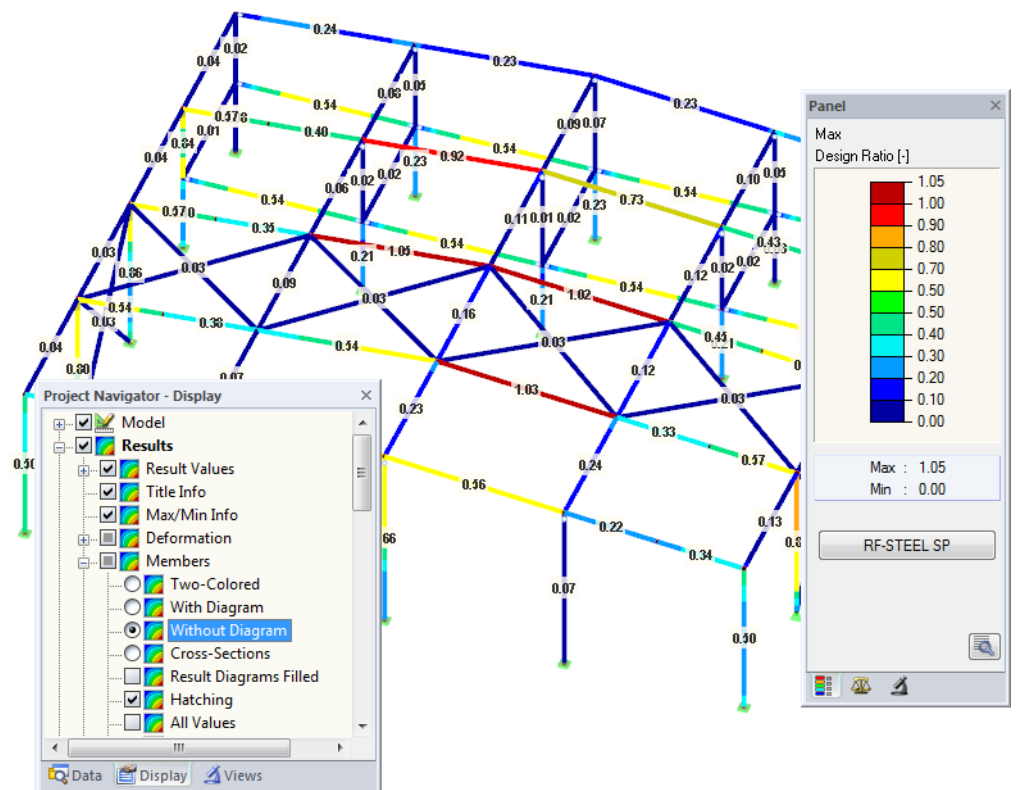

Figure 5.4: Design ratios with display option *Without Diagram*

This graphics of the design results can be transferred to the printout report (see chapter 6.2, page 44).

To return to the RF-STEEL SP module, click [RF-STEEL SP] in the panel.

RF-STEEL SP

5.2 Result Diagrams

You can also graphically evaluate a member's result distributions in the result diagram.



To do this, select the member (or set of members) in the RF-STEEL SP results window by clicking in the table row of the member. Then open the *Result Diagram on Member* dialog box by clicking the button shown on the left. The button is located below the upper results table (see Figure 5.1, page 38).



The result diagrams are also available in the RFEM graphic. To display the diagrams, click

Results → Result Diagrams for Selected Members

or use the button in the RFEM toolbar shown on the left.

A window opens, graphically showing the distribution of the maximum design values on the member or set of members.

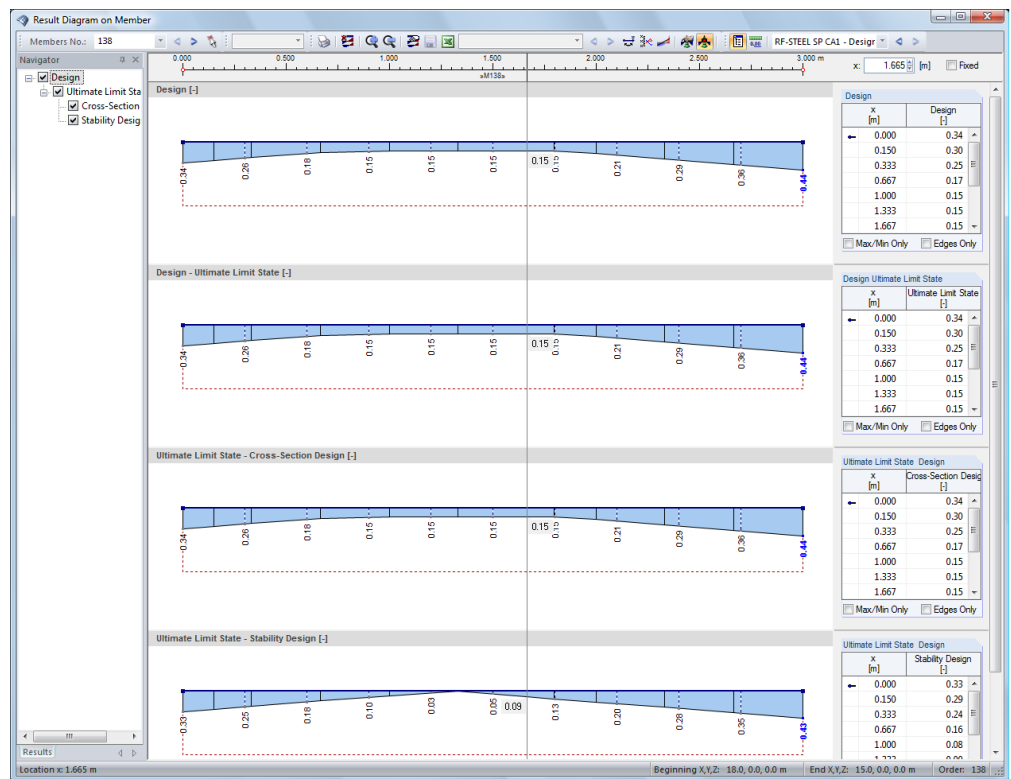
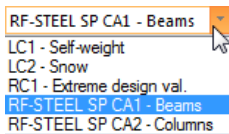

Figure 5.5: Dialog box *Result Diagram on Member*



Use the list in the toolbar above to choose the relevant RF-STEEL SP design case.

The *Result Diagram on Member* dialog box is described in the RFEM manual, chapter 9.5.

5.3 Filter for Results

The RF-STEEL SP results windows allow you to sort the results by various criteria. In addition, you can use the filter options described in chapter 9.9 of the RFEM manual to evaluate the design results graphically.

You can use the *Visibility* options also for RF-STEEL SP (see RFEM manual, chapter 9.9.1) to filter the members in order to evaluate them.

Filtering designs

The design ratios can easily be used as filter criteria in the RFEM work window which you can access by clicking [Graphics]. To apply this filter function, the panel must be displayed. If it is not shown, click

View → Control Panel (Color Scale, Factors, Filter)

or use the toolbar button shown on the left.

The panel is described in the RFEM manual, chapter 3.4.6. The filter settings for the results must be defined in the first panel tab (Color spectrum). As this register is not available for the two-colored results display, you have to use the *Display* navigator and set the display options *Colored With/Without Diagram* or *Cross-Sections* first.

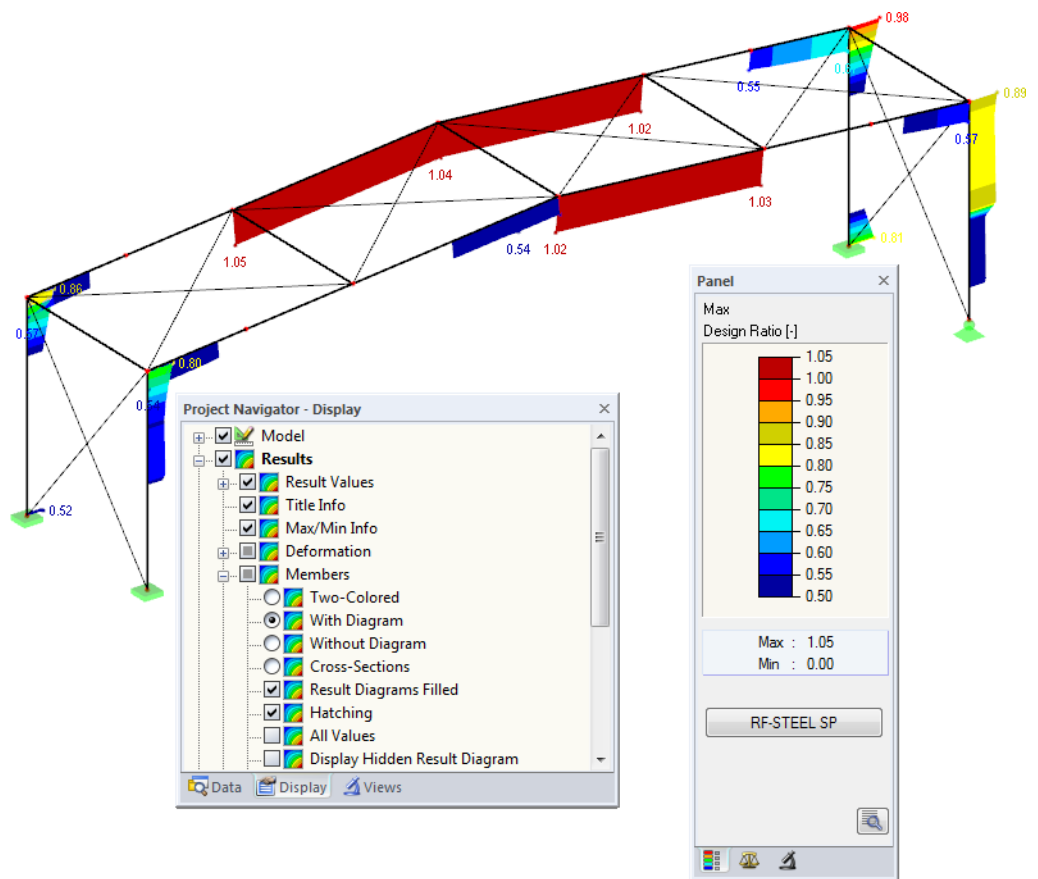

Figure 5.6: Filtering design ratios with adjusted color spectrum

As the figure above shows, the color spectrum can be set in such a way that only ratios higher than 0.50 are shown in a color range between blue and red.

If you select the *Display Hidden Result Diagram* option in the *Display* navigator (*Results* → *Members*), you can display all stress ratio diagrams that are not covered by the color spectrum. Those diagrams are represented by dotted lines.

Filtering members



In the *Filter* tab of the control panel, you can specify the numbers of particular members to display their results exclusively, that is, filtered. This function is described in detail in the RFEM manual, chapter 9.9.3.

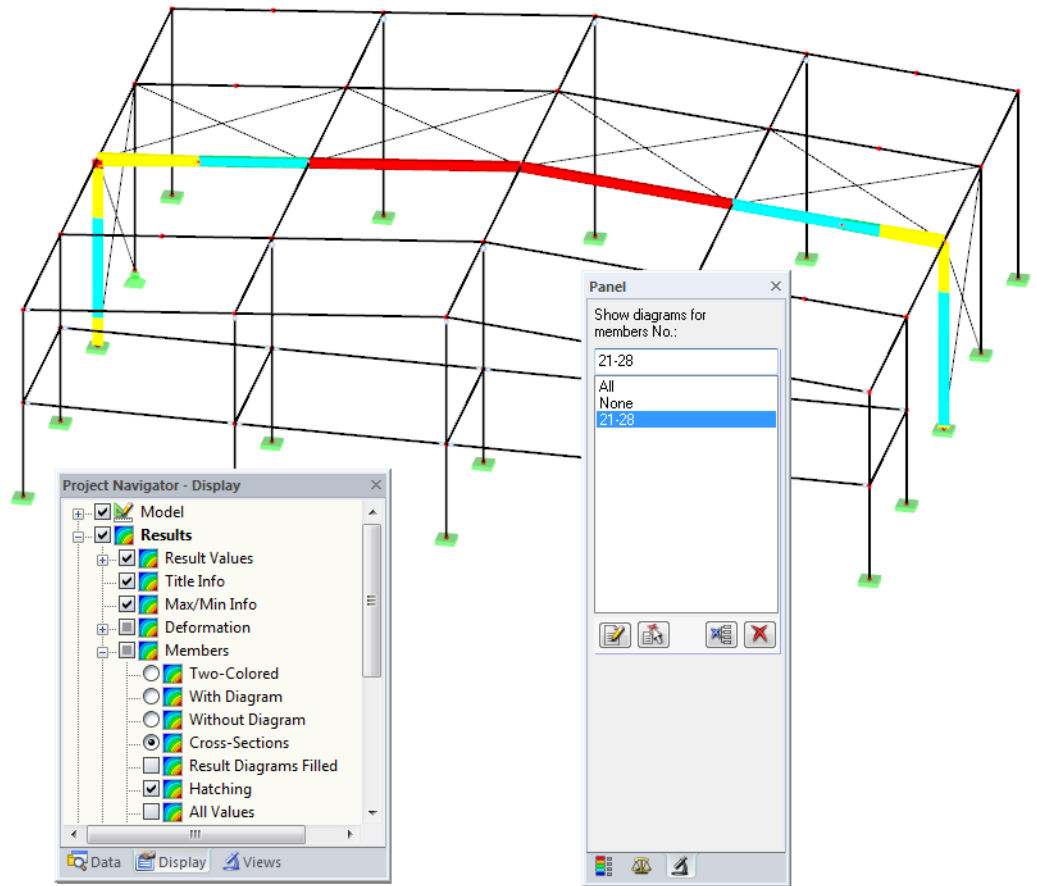

Figure 5.7: Member filter for the stress ratios of a hall frame

Unlike the partial view function (*Visibilities*), the graphic displays the entire model. The figure above shows the design ratios of a hall frame. The remaining members are displayed in the model but are shown without design ratios.

6. Printout

6.1 Printout Report

Similar to RFEM, the program generates a printout report for the RF-STEEL SP results, to which graphics and descriptions can be added. The selection in the printout report determines what data from the design module will be included in the printout.



The printout report is described in the RFEM manual. In particular, chapter 10.1.3.4 *Selecting Data of Add-on Modules* describes how to select input and output data of add-on modules for the printout.

For complex structural systems with many design cases, it is recommended to split the data into several printout reports, thus allowing for a clearly-arranged printout.

6.2 RF-STEEL SP Graphic Printout

In RFEM, you can add every picture that is displayed in the work window to the printout report or send it directly to a printer. In this way, you can prepare the design ratios displayed on the RFEM model for the printout, too.



The printing of graphics is described in the RFEM manual, chapter 10.2.

Designs in the RFEM model

To print the currently displayed graphic of the design ratios, click



File → **Print Graphic**

or use the toolbar button shown on the left.

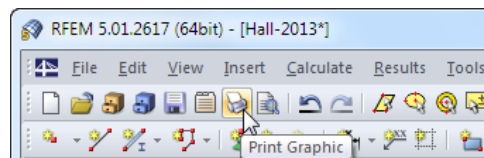

Figure 6.1: Button *Print Graphic* in RFEM toolbar

Result Diagrams

You can also transfer the *Result Diagram on Member* to the report by using the [Print] button. It is also possible to print it directly.

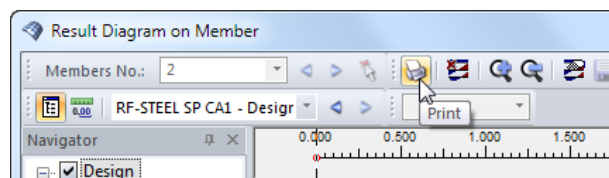

Figure 6.2: Button *Print Graphic* in the dialog box *Result Diagram on Member*

The dialog box *Graphic Printout* opens (see figure on next page).

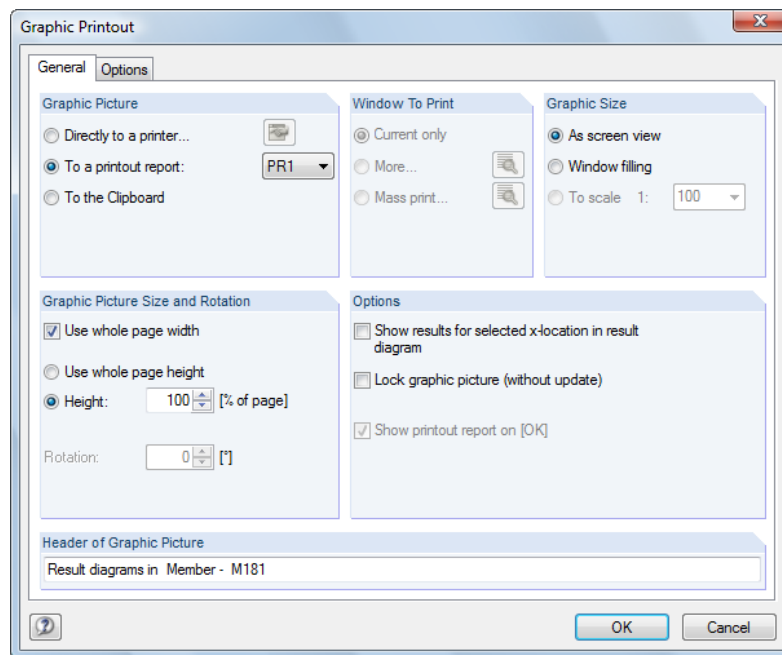

Figure 6.3: Dialog box *Graphic Printout*, tab *General*

This dialog box is described in the RFEM manual, chapter 10.2. The RFEM manual also describes the *Options* and *Color Spectrum* tab.

You can move a graphic anywhere within the printout report by using the drag-and-drop function.

To adjust a graphic subsequently in the printout report, right-click the relevant entry in the navigator of the printout report. The option *Properties* in the context menu opens the dialog box *Graphic Printout*, offering various options for adjustment.

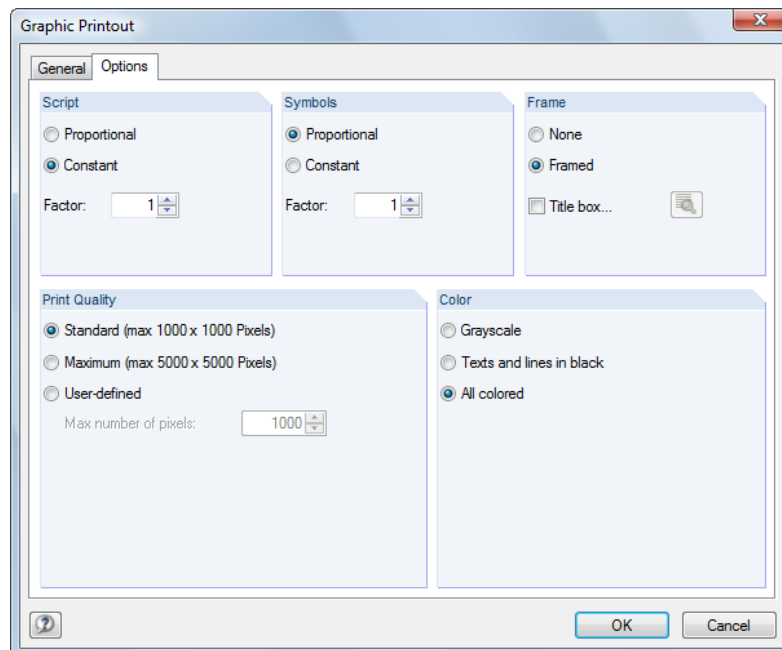
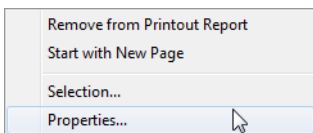

Figure 6.4: Dialog box *Graphic Printout*, tab *Options*

7. General Functions

This chapter describes useful menu functions as well as export options for the designs.

7.1 Design Cases

Design cases allow you to group members for the design: In this way, you can combine groups of structural components or analyze members with particular design specifications (for example changed materials, partial safety factors, optimization).

It is no problem to analyze the same member or set of members in different design cases.

To calculate a RF-STEEL SP design case, you can also use the load case list in the RFEM toolbar.

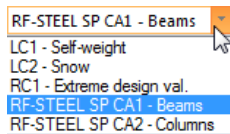

Create New Design Case

To create a new design case, use the RF-STEEL SP menu and click

File → New Case.

The following dialog box appears:

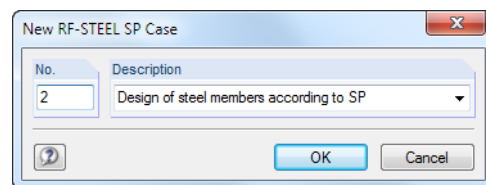

Figure 7.1: Dialog box *New RF-STEEL SP Case*

In this dialog box, enter a *No.* (one that is still available) for the new design case. The corresponding *Description* will make the selection in the load case list easier.

Click [OK] to open the RF-STEEL SP window 1.1 *General Data* where you can enter the design data.

Rename a Design Case

To change the description of a design case, use the RF-STEEL SP menu and click

File → Rename Case.

The following dialog box appears:

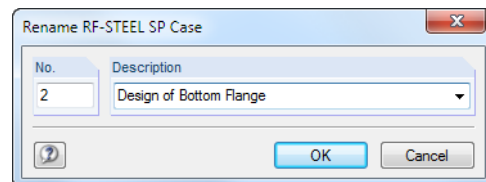

Figure 7.2: Dialog box *Rename RF-STEEL SP Case*

In this dialog box, you can define a different *Description* as well as a different *No.* for the design case.

Copy a Design Case

To copy the input data of the current design case, use the RF-STEEL SP menu and click

File → **Copy Case**.

The following dialog box appears:

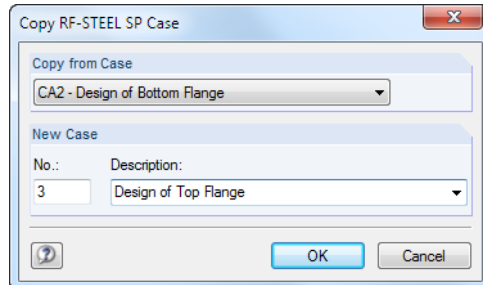

Figure 7.3: Dialog box *Copy RF-STEEL SP Case*

Define the *No.* and, if necessary, a *Description* for the new case.

Delete a Design Case

To delete design cases, use the RF-STEEL SP menu and click

File → **Delete Case**.

The following dialog box appears:

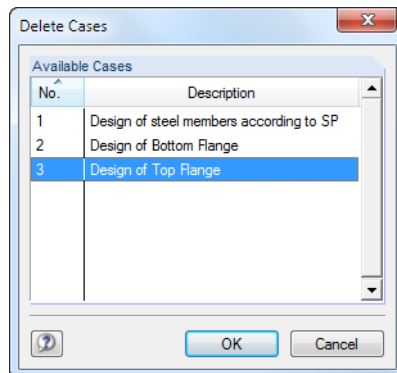
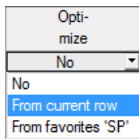

Figure 7.4: Dialog box *Delete Cases*

The design case can be selected in the list *Available Cases*. To delete the selected case, click [OK].

7.2 Cross-Section Optimization



The design module offers you the option to optimize overloaded or little utilized cross-sections. To do this, select in column D or E of the relevant cross-sections in the 1.3 *Cross-Sections* window whether to determine the cross-section *From the current row* or the user-defined *Favorites* (see Figure 2.8, page 14). You can also start the cross-section optimization in the results windows by using the context menu

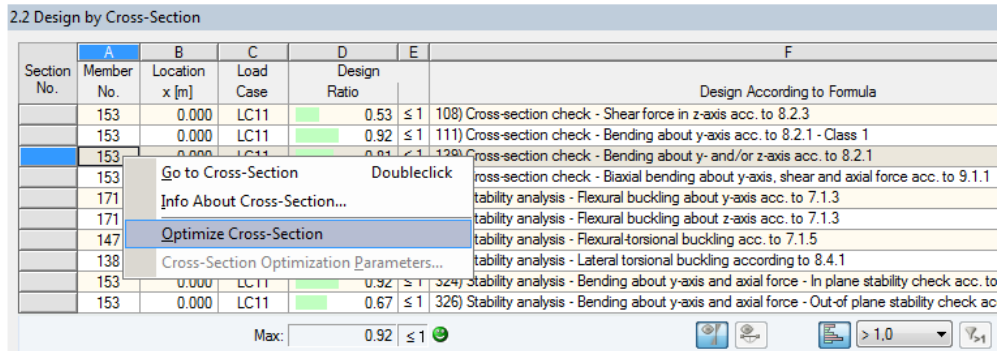

Figure 7.5: Context menu for cross-section optimization

During the optimization process, the module determines the cross-section that fulfills the analysis requirements in the most optimal way, that is, comes as close as possible to the maximum allowable design ratio specified in the *Details* dialog box (see Figure 3.1, page 25). The required cross-section properties are determined with the internal forces from RFEM. If another cross-section proves to be more favorable, this cross-section is used for the design. Then, the graphic in window 1.3 shows two cross-sections: the original cross-section from RFEM and the optimized one (see Figure 7.7).

For a parameterized cross-section, the following dialog box appears when you select 'Yes' from the drop-down list.

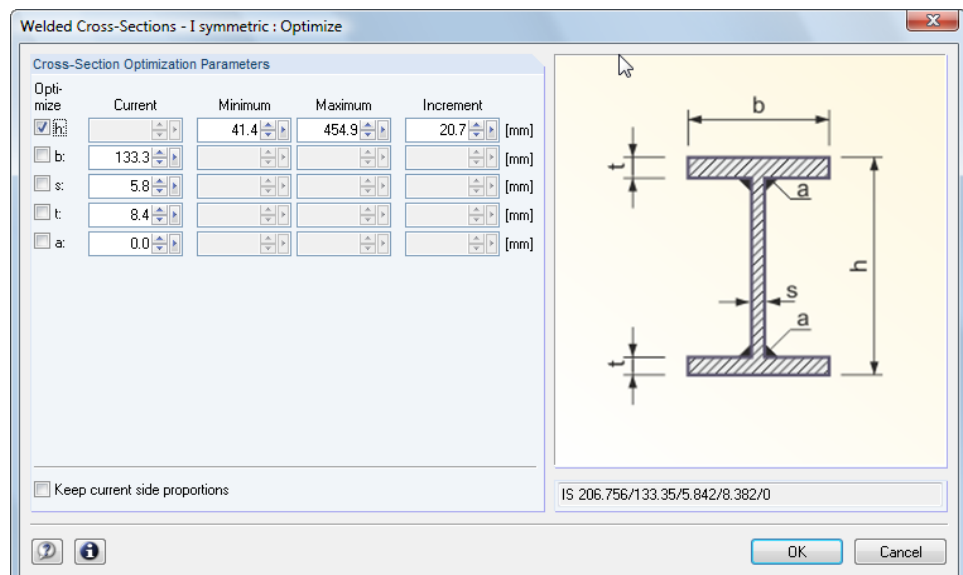

Figure 7.6: Dialog box *Welded Cross-Sections - I symmetric : Optimize*

By selecting the check boxes in the *Optimize* column, you decide which parameter(s) you want to modify. This enables the *Minimum* and *Maximum* columns, where you can specify the upper and lower limits of the parameter. The *Increment* column determines the interval in which the size of the parameter varies during the optimization process.

If you want to *Keep current side proportions*, select the corresponding check box. In addition, you have to select at least two parameters for optimization.

Cross-sections based on combined rolled cross-sections cannot be optimized.



Please note that the internal forces are not automatically recalculated with the changed cross-sections during the optimization: It is up to you to decide which cross-sections should be transferred to RFEM for recalculation. As a result of optimized cross-sections, internal forces may vary significantly because of the changed stiffnesses in the structural system. Therefore, it is recommended to recalculate the internal forces of the modified cross-section data after the first optimization, and then to optimize the cross-sections once again.

You can export the modified cross-sections to RFEM: Go to the 1.3 *Cross-Sections* window, and then click

Edit → Export All Cross-Sections to RFEM.

Alternatively, you can use the context menu in window 1.3 to export optimized cross-sections to RFEM.

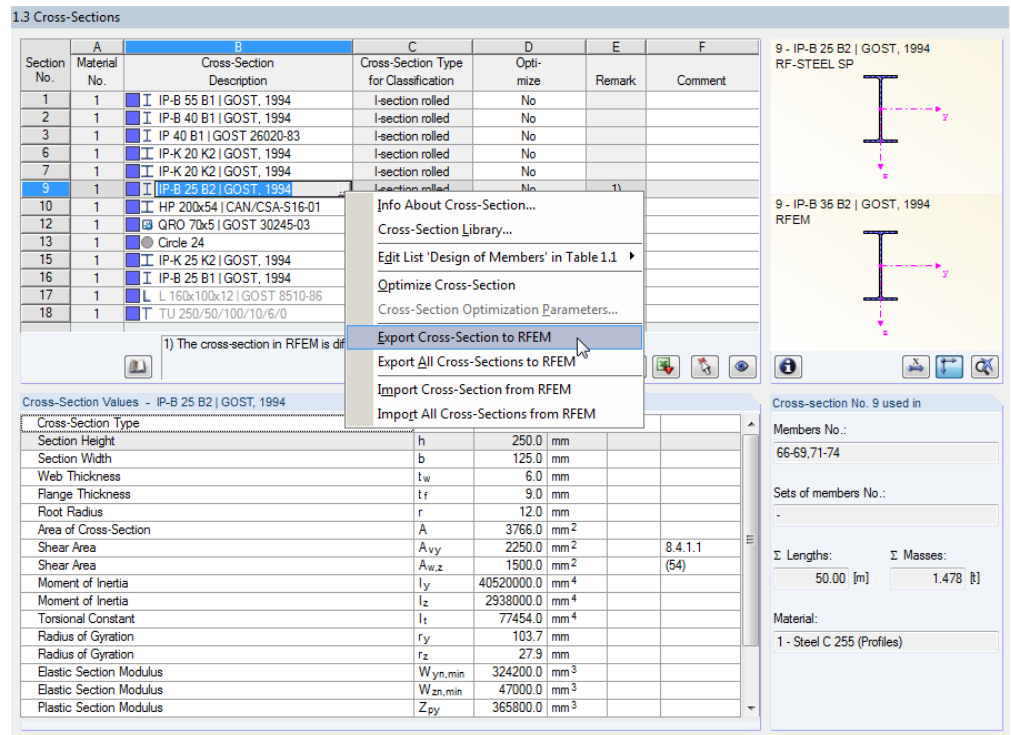

Figure 7.7: Context menu in window 1.3 *Cross-Sections*

Before the modified cross-sections are transferred to RFEM, a security query appears as to whether the results of RFEM should be deleted.

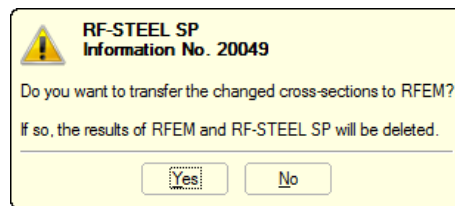

Figure 7.8: Query before transfer of modified cross-sections to RFEM



By confirming the query and then starting the [Calculation] in the RF-STEEL SP module, the RFEM internal forces as well as the designs will be determined in one single calculation run.



If the modified cross-sections have not been exported to RFEM yet, you can import the original cross-sections in the design module by using the options shown in Figure 7.7. Please note that this option is only available in window 1.3 *Cross-sections*.

If you optimize a tapered member, the program modifies the member start and end. Then it linearly interpolates the second moments of area for the intermediate locations. As these moments are considered with the fourth power, the designs may be inaccurate if the depths of the start and end cross-section differ considerably. In such a case, it is recommended to divide the taper into several members, thus manually modeling the taper layout.

7.3 Units and Decimal Places

Units and decimal places for RFEM and the add-on modules are managed in one dialog box. In RF-STEEL SP, you can use the menu to define the units. To open the corresponding dialog box, click

Settings → Units and Decimal Places.

The program opens the following dialog box that you already know from RFEM. RF-STEEL SP will be preset in the list *Program / Module*.

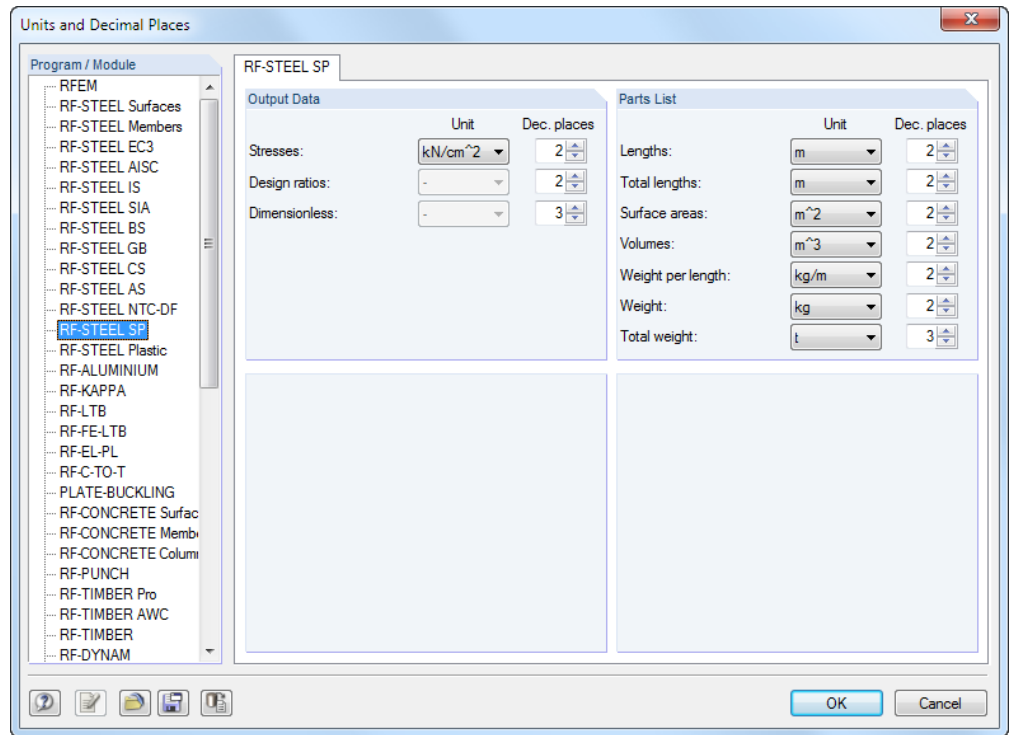

Dialog box *Units and Decimal Places*



You can save the settings as user profile to reuse them in other models. These functions are described in the RFEM manual, chapter 11.1.3.

7.4 Data Transfer

7.4.1 Export Material to RFEM

If you have adjusted the materials in RF-STEEL SP for design, you can export the modified materials to RFEM in a similar manner as you export members and cross-sections: Open window 1.2 *Materials*, and then click

Edit → **Export All Materials to RFEM**.

You can also export the modified materials to RFEM by using the context menu of window 1.2.

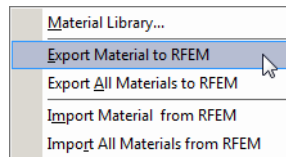

Figure 7.9: Context menu of window 1.2 *Materials*

Calculation

Before the modified materials are transferred to RFEM, a security query appears as to whether the results of RFEM should be deleted. When you have confirmed the query and then start the [Calculation] in RF-STEEL SP, the RFEM internal forces and designs are determined in one single calculation run.

If the modified materials have not been exported to RFEM yet, you can transfer the original materials to the design module, using the options shown in Figure 7.9. Please note, however, that this option is only available in window 1.2 *Materials*.

7.4.2 Export Effective Lengths to RFEM

If you have adjusted the materials in RF-STEEL SP for design, you can export the modified materials to RFEM in a similar manner as you export cross-sections: Open window 1.5 *Effective Lengths - Members*, and then click

Edit → **Export All Effective Lengths to RFEM**.

or use the corresponding option on the context menu of window 1.5.

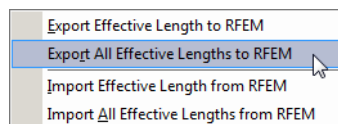

Figure 7.10: Context menu of window 1.5 *Effective Lengths - Members*

Before the modified materials are transferred to RFEM, a security query appears as to whether the results of RFEM should be deleted.

If the modified effective lengths have not been exported to RFEM yet, you can retransfer the original effective lengths to the design module, using the options shown in Figure 7.10. Please note, however, that this option is only available in window 1.5 *Effective Lengths - Members* and 1.6 *Effective Lengths - Sets of Members*.

7.4.3 Export Results

The RF-STEEL SP results can also be used by other programs.

Clipboard

To copy cells selected in the results windows to the Clipboard, press the keys [Ctrl]+[C]. To insert the cells, for example in a word-processing program, press [Ctrl]+[V]. The headers of the table columns will not be transferred.

Printout report

You can print the data of the RF-STEEL SP add-on module into the global printout report (see chapter 6.1, page 44) for export. Then, in the printout report, click

File → Export to RTF.

The function is described in the RFEM manual, 10.1.11.

Excel / OpenOffice

RF-STEEL SP provides a function for the direct data export to MS Excel, OpenOffice.org Calc or the file format CSV. To open the corresponding dialog box, click

File → Export Tables.

The following export dialog box appears

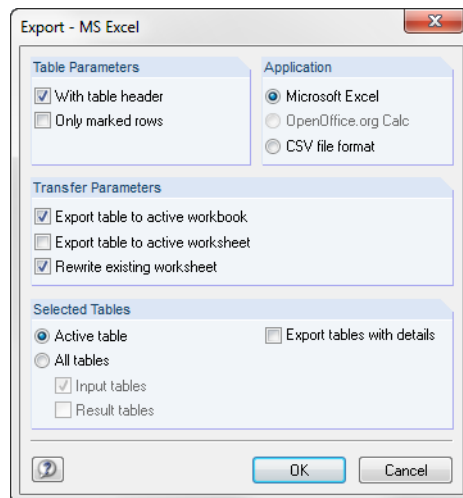

Figure 7.11: Dialog box *Export - MS Excel*

When you have selected the relevant parameters, you can start the export by clicking [OK]. Excel or OpenOffice will be started automatically, that is, the programs do not have to be opened first.

	A	B	C	D	E	F	G
1	Section	Member	Location	Load	Design		
2	No.	No.	x [m]	Case	Ratio		
3	1	IP-B 55 B1	GOST, 1994				Design According to Formula
4		39	3,000	LC4	0,00 ≤ 1	100	Negligible internal forces
5		21	0,000	LC2	0,02 ≤ 1	102	Cross-section check - Compression acc. to 7.1.1
6		2	6,000	LC4	0,01 ≤ 1	106	Cross-section check - Shear force in y-axis acc. to 8.2.3
7		32	0,000	LC2	0,14 ≤ 1	108	Cross-section check - Shear force in z-axis acc. to 8.2.3
8		21	6,000	LC2	0,39 ≤ 1	111	Cross-section check - Bending about y-axis acc. to 8.2.1 - Class 1
9		1	3,000	LC4	0,12 ≤ 1	116	Cross-section check - Bending about z-axis acc. to 8.2.1 - Class 1
10		21	6,000	LC2	0,34 ≤ 1	139	Cross-section check - Bending about y- and/or z-axis acc. to 8.2.1
11		21	6,000	LC2	0,35 ≤ 1	181	Cross-section check - Biaxial bending about y-axis, shear and axial force acc. to 9.1.1
12		21	0,000	LC2	0,02 ≤ 1	301	Stability analysis - Flexural buckling about y-axis acc. to 7.1.3
13		21	0,000	LC2	0,05 ≤ 1	311	Stability analysis - Flexural buckling about z-axis acc. to 7.1.3
14		21	6,000	LC2	0,45 ≤ 1	313	Stability analysis - Flexural-torsional buckling acc. to 7.1.5
15		1	6,000	LC2	0,30 ≤ 1	322	Stability analysis - Lateral torsional buckling according to 8.4.1
16		21	6,000	LC2	0,39 ≤ 1	324	Stability analysis - Bending about y-axis and axial force - In plane stability check acc. to 9.2.2
17		21	1,000	LC2	0,64 ≤ 1	328	Stability analysis - Bending about y-axis and axial force - Out-of plane stability check acc. to 9.2.4
18							
19	2	IP-B 40 B1	GOST, 1994				
20		45	0,000	LC4	0,01 ≤ 1	100	Negligible internal forces
21		26	0,000	LC4	0,01 ≤ 1	101	Cross-section check - Tension acc. to 7.1.1
22		41	0,000	LC2	0,06 ≤ 1	102	Cross-section check - Compression acc. to 7.1.1
23		23	0,000	LC2	0,15 ≤ 1	108	Cross-section check - Shear force in z-axis acc. to 8.2.3
24		23	0,000	LC2	0,99 ≤ 1	111	Cross-section check - Bending about y-axis acc. to 8.2.1 - Class 1
25		23	0,000	LC2	0,86 ≤ 1	139	Cross-section check - Bending about y- and/or z-axis acc. to 8.2.1
26		23	0,000	LC2	0,89 ≤ 1	181	Cross-section check - Biaxial bending about y-axis, shear and axial force acc. to 9.1.1

Figure 7.12: Results in Excel

8. Example

Column with Biaxial Bending

In this example, the stability design of buckling and lateral buckling is carried out by analyzing the relevant interaction conditions according to [1].

Design values

System and loads

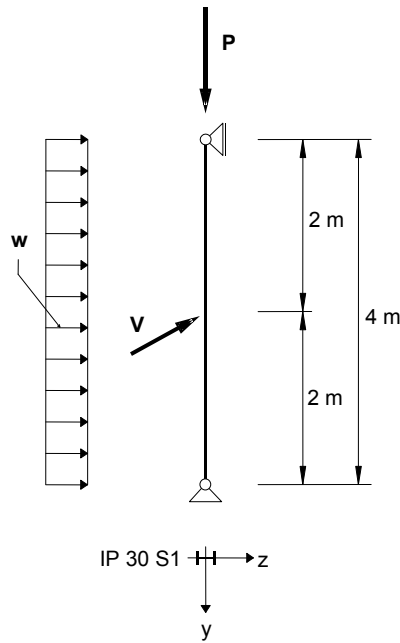

Design values of static loads:

$P = 300 \text{ kN}$
 $w = 5.0 \text{ kN/m}$
 $V = 7.5 \text{ kN}$

Cross-section: IP 30 S1

Material: C 275

Figure 8.1: System and design loads (γ -fold)

Internal forces according to linear static analysis

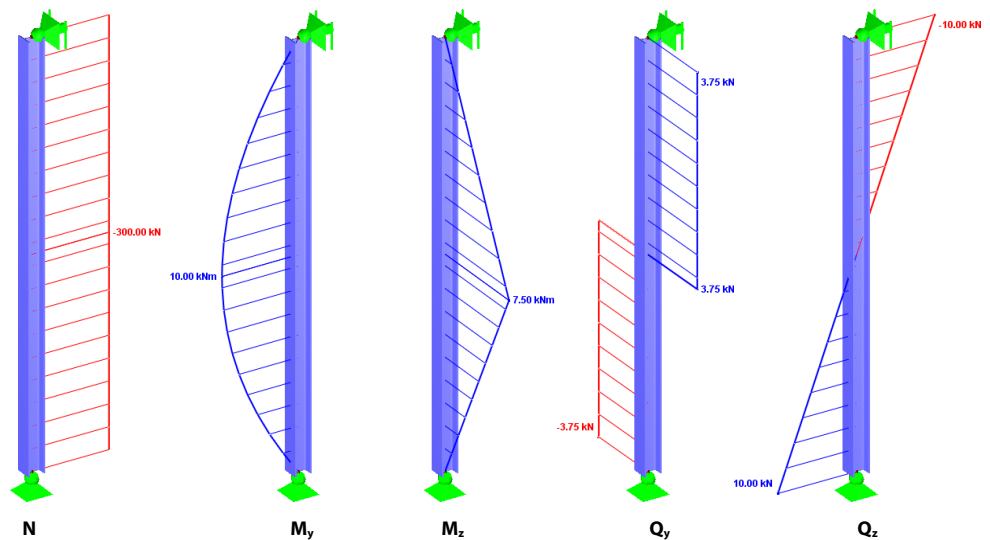

Figure 8.2: Internal Forces

Design location (decisive location x)

The design is performed for all locations x (see chapter 4.5) of the member. The following internal forces act in the decisive location at x = 2.00 m:

$$N = -300.00 \text{ kN} \quad M_y = 10.00 \text{ kNm} \quad M_z = 7.50 \text{ kNm} \quad Q_y = 3.75 \text{ kN} \quad Q_z = 0.00 \text{ kN}$$

Cross-section properties IP 30 S1

Property	Symbol	Value	Unit
Area of cross-section	A_g	68.31	cm ²
Moment of inertia	I_y	10400.00	cm ⁴
Moment of inertia	I_z	1040.00	cm ⁴
Radius of inertia	r_y	12.34	cm
Radius of inertia	r_z	4.64	cm
Cross-section weight	G	53.60	kg/m
Moment of torsional rigidity	J	22.34	cm ⁴
Warping moment of inertia	C_w	287500.00	cm ⁶
Elastic cross-section modulus	$W_{y,min}$	715.00	cm ³
Elastic cross-section modulus	$W_{z,min}$	147.00	cm ³

Material properties C 275

Property	Symbol	Value	Unit
Characteristic strength	R_{yn}	27.50	kN/cm ²
Partial safety factor	γ_m	1.025	-
Design strength	R_y	26.83	kN/cm ²
Modulus of elasticity	E	21000.00	kN/cm ²

Slenderness check of cross-section – Tables 9 and 10**Compression according to 7.3****Flange – Table 10**Slenderness

$$\lambda_f = (b_{ef} / t_f) \sqrt{R_y / E}$$

$$R_y = 26.83 \text{ kN/cm}^2$$

$$E = 21000 \text{ kN/cm}^2$$

$$b_{ef} / t_f = 7.8 / 1.1 = 7.091$$

$$\lambda_f = (b_{ef} / t_f) \sqrt{R_y / E} = 7.091 \sqrt{26.83 / 21000} = 0.253$$

Limit slenderness ratio

$$\bar{\lambda}_{uf} = 0.36 + 0.10 \bar{\lambda}$$

$$\bar{\lambda} = \lambda \sqrt{R_y / E}$$

$$\lambda = \max(\lambda_y, \lambda_z)$$

$$\lambda = \max(l_{ef,y} / i_y, l_{ef,z} / i_z) = \max(400 / 12.34, 400 / 4.64) = \max(32.42, 86.22) = 86.22$$

8 Example

$$R_y = 26.83 \text{ kN/cm}^2$$

$$E = 21000 \text{ kN/cm}^2$$

$$\bar{\lambda} = 86.22 \sqrt{26.83 / 210000} = 3.082$$

$$\bar{\lambda}_{uf} = 0.36 + 0.10 \bar{\lambda} = 0.36 + 0.1 \cdot 3.082 = 0.668$$

$$\lambda_f < \bar{\lambda}_{uf}$$

- Stiffeners are not necessary

Web - Table 9

Slenderness

$$\lambda_w = (h_{ef} / t_w) \sqrt{R_y / E}$$

$$R_y = 26.83 \text{ kN/cm}^2$$

$$E = 21000 \text{ kN/cm}^2$$

$$h_{ef} / t_w = 23.3 / 0.8 = 29.12$$

$$\lambda_w = (h_{ef} / t_w) \sqrt{R_y / E} = 29.12 \sqrt{26.83 / 210000} = 1.041$$

Limit slenderness ratio

$$\bar{\lambda} = 86.22 \sqrt{26.83 / 210000} = 3.082$$

for $\bar{\lambda} > 2.0$

$$\bar{\lambda}_{uw} = 1.20 + 0.35 \bar{\lambda}$$

$$\bar{\lambda}_w = 1.20 + 0.35 \bar{\lambda} = 1.20 + 0.35 \cdot 3.082 = 2.60$$

$$\lambda_w < \bar{\lambda}_{uw}$$

- Reduction of cross-section area is not necessary

Cross section check

Shear and bending according to 8.2

Design Formula (44):

$$\frac{0.87}{R_y \gamma_c} \sqrt{\sigma_y^2 - \sigma_y \sigma_z + \sigma_z^2 + 3\tau_{yz}^2} \leq 1.0$$

This formula is applied to the stresses due to bending and shear that exist at the most exposed stress point no. 1 of the cross-section (see figure to the left).

$$\frac{0.87}{26.83 \cdot 0.95} \sqrt{1.4^2 - 1.4 \cdot 5.1 + 5.1^2 + 0} \leq 1.0$$

$$\frac{0.87}{26.83 \cdot 0.95} \cdot 5.92 \leq 1.0$$

$$0.20 \leq 1.0$$

- OK

Design Formula (44):

$$\frac{\tau_{yz}}{R_s \gamma_c} \leq 1.0$$

This part of the formula is applied to the shear stresses that exist at stress point no. 3.

$$\frac{0.13}{15.56 \cdot 0.95} \leq 1.0$$

$$0.01 \leq 1.0$$

- OK

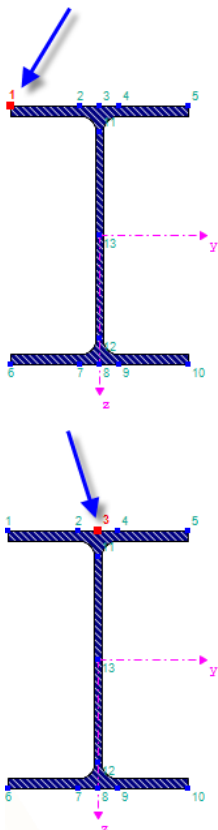

Biaxial bending and compressive force according to 9.1.1

Design Formula (105):

$$\left(\frac{N}{A_n R_y \gamma_c}\right)^n + \left(\frac{M_y}{c_y W_{y,n,\min} R_y \gamma_c}\right) + \left(\frac{M_z}{c_z W_{z,n,\min} R_y \gamma_c}\right) \leq 1.0$$

$$A_f / A_w = 20 \cdot 1.1 / 26.9 \cdot 8 = 1.02$$

We linearly interpolate the values in Table F.1 to determine these coefficients:

$$c_y = 1.069, \quad c_z = 1.47, \quad n = 1.5$$

Service factor for columns: $\gamma_c = 0.95$

$$\left(\frac{300}{68.31 \cdot 26.83 \cdot 0.95}\right)^{1.5} + \left(\frac{1000}{1.069 \cdot 715 \cdot 26.83 \cdot 0.95}\right) + \left(\frac{750}{1.47 \cdot 147 \cdot 26.83 \cdot 0.95}\right) \leq 1.0$$

$$(0.17)^{1.5} + 0.05 + 0.14 \leq 1.0$$

$$0.26 \leq 1.0$$

- OK

Stability check**Biaxial bending and compressive force according to 9.2**

Design Formula (116):

$$N / (\varphi_{eyz} A R_y \gamma_c) \leq 1.0$$

Design Formula (117):

$$\varphi_{eyz} = \varphi_{ez} (0.6\sqrt[3]{\bar{\lambda}_z} + 0.4\sqrt[4]{\bar{\lambda}_z})$$

For the linear interpolation of φ_{ez} according to Table E.3, the values of the relative eccentricity $m_{ef,z}$ and of the flexibility $\bar{\lambda}_z$ are required.

$$\bar{\lambda}_z = \lambda_z \sqrt{R_y / E}$$

$$\bar{\lambda}_z = 86.22 \sqrt{26.83 / 210000} = 3.082$$

$$m_{ef,z} = \eta m_z$$

where m_z eccentricity ratio
 η coefficient of cross-section shape acc. to Table E.2

$$m_z = e_z A / W_{c,z}$$

 $W_{c,z}$ is the sectional modulus computed for the most compressed fiber.

$$e_z = M_z / N$$

$$e_z = 750 / 300 = 2.5 \text{ cm}$$

$$m_z = 2.5 \cdot 68.31 / 147 = 1.16$$

For $\bar{\lambda}_z = 3.082$, $m_z = 1.16$ and $A_f / A_w = 1.022$, the shape coefficient η according to Table E.2 can be determined as follows:

$$\eta = (1.90 - 0.1 \cdot m_z) - 0.02(6 - m_z) \cdot \bar{\lambda}_z$$

$$\eta = (1.90 - 0.1 \cdot 1.16) - 0.02(6 - 1.16) \cdot 3.082 = 1.485$$

$$m_{ef,z} = 1.485 \cdot 1.16 = 1.723$$

8 Example

For $m_{ef,z} = 1.723$ and $\bar{\lambda}_z = 3.082$, the value of φ_{ez} can be linearly interpolated according to Table E.3:

$$\varphi_{ez} = 0.337$$

The coefficient c is to be calculated according to Formulas (112), (113) or (114).

$$m_y = e_y A / W_{c,y}$$

$$e_y = M_y / N$$

$$e_y = 1000 / 300$$

$$e_y = 3.33 \text{ cm}$$

$$m_y = 3.33 \cdot 68.31 / 715 = 0.318$$

For the eccentricity ratio $m_y < 5$, Formula (112) is to be applied to determine the coefficient c .

$$c = \beta / (1 + \alpha m_y) \leq 1.0$$

The coefficients α and β are taken from Table 21.

$$c = 1.0 / (1 + 0.7 \cdot 0.318) \leq 1.0$$

$$c = 0.818$$

We can now apply the coefficient c in Formula (117):

$$\varphi_{eyz} = \varphi_{ez} (0.6\sqrt[3]{c} + 0.4\sqrt[4]{c})$$

$$\varphi_{eyz} = 0.337 (0.6\sqrt[3]{0.818} + 0.4\sqrt[4]{0.818}) = 0.318$$

Finally we get from Formula (118):

$$N / (\varphi_{eyz} A R_y \gamma_c) \leq 1.0$$

$$300 / (0.318 \cdot 68.31 \cdot 26.83 \cdot 0.95) \leq 1.0$$

$$0.542 \leq 1.0$$

- OK

A Literature

- [1] Code of Rules for Steel Structures SP 16.13330.2011, Revised version SNIP II-23-81*, Moscow 2011
- [2] Rules for Member Stability in EN 1993-1-1, ECCS Technical Committee 8 - Stability

B Index

B	
Background graphic.....	39
Beam type.....	23
Buckling.....	20
Buckling about axis	21
Buttons	38
C	
Calculation.....	25
Cantilever.....	18, 23
Clipboard	51
Color spectrum	42
Colored design.....	42
Column buckling.....	18, 19
Control panel.....	42
Coordinate system.....	14
Cross-section	14, 48
Cross-section class.....	26
Cross-section design.....	30
Cross-section library.....	14
Cross-section optimization	48
Cross-section type	15
Cross-sectional area	24
D	
Decimal places.....	12, 50
Deflection	25
Deformation analysis.....	23
Design	9, 15, 28, 29, 30
Design case	39, 46, 47
Design situation.....	30
Details	25
Display navigator	40, 42
E	
Effective length.....	19, 22, 51
Effective slenderness	25
Excel.....	52
Exit RF-STEEL SP.....	8
Export.....	51
Export cross-section.....	49
Export effective length.....	51
Export material.....	51
F	
Favorites.....	48
Filter	42
Filtering members	43
G	
General Data.....	8
Graphic	39
Graphic printout.....	44
H	
Hidden result diagram	42
I	
Info about cross-section.....	16
Installation	5
Intermediate Lateral Restraints.....	18
Intermediate restraints	18
Internal forces	33, 49
K	
K factor	20
L	
Lateral restraint	18
Lateral torsional buckling	18, 21
Length	19, 36
List of members.....	23
Load application	26
Load case.....	9, 11, 33
Load combination	9
Location x.....	29
M	
Material	51
Material description.....	12
Material library.....	13
Material properties.....	12
Materials	12
Members.....	9
N	
Navigator	8
O	
OpenOffice.....	52
Optimization	15, 26, 48, 49
P	
Panel.....	7, 40, 42
Parameterized cross-section.....	48
Parameters.....	24

Part.....	36	Slenderness.....	35
Partial safety factors.....	26	Spacial cases.....	26
Parts list.....	36, 37	Stability analysis.....	26
Plastic design.....	26	Stainless steel.....	13
Precamber.....	23	Start calculation.....	27
Print.....	44	Start program.....	6
Printout report.....	44, 45	Start RF-STEEL SP.....	6
R		Stress point.....	17
Reference length.....	11	Sum.....	37
Reference scales.....	38	Surface area.....	36
Relatively.....	18	T	
Remark.....	16	Tapered member.....	16, 30, 50
Rendering.....	42	Torsional support.....	18
Result combination.....	9, 10	Transverse load.....	26
Result diagram.....	41, 44	U	
Results evaluation.....	38	Ultimate limit state.....	9, 38
Results representation.....	40	Undeformed system.....	25
Results values.....	39	Units.....	12, 50
Results window.....	28	User profile.....	50
RFEM graphic.....	44	V	
RFEM work window.....	39	View mode.....	38, 39
RF-STABILITY.....	20	Visibilities.....	42
S		Volume.....	37
Selecting windows.....	8	W	
Service factor.....	24	Weight.....	37
Serviceability.....	25	Windows.....	8
Serviceability limit state.....	11, 23, 25, 38	X	
Set of members.....	9, 22, 23, 31, 34, 37	x-location.....	33
Shifted member ends.....	25		