

**Version**  
**October 2013**

**Add-on Module**

# **RF-GLASS**

**Design of Single Layer,  
Laminated, and Insulating Glass**

## **Program Description**

All rights, including those of translations, are reserved.

No portion of this book may be reproduced – mechanically, electronically, or by any other means, including photocopying – without written permission of DLUBAL SOFTWARE GMBH.

© **Dlubal Software GmbH**  
**Am Zellweg 2 D-93464 Tiefenbach**

Tel.: +49 9673 9203-0  
Fax: +49 9673 9203-51  
E-Mail: [info@dlubal.com](mailto:info@dlubal.com)  
Web: [www.dlubal.com](http://www.dlubal.com)



# Contents

Contents		Page	Contents		Page
<b>1.</b>	<b>Introduction</b>	<b>4</b>	4.3.3	Standard – None	52
1.1	Add-on Module RF-GLASS	4	4.4	Start calculation	54
1.2	RF-GLASS Team	5	<b>5.</b>	<b>Results</b>	<b>55</b>
1.3	Using the Manual	6	5.1	Max Stress/Ratio by Loading	56
1.4	Open the RF-GLASS module	6	5.2	Max Stress/Ratio by Surface	58
<b>2.</b>	<b>Theoretical background</b>	<b>8</b>	5.3	Stresses in All Points	59
2.1	Symbols	8	5.4	Line Support Reactions	60
2.2	Types of Glass Structures	9	5.5	Nodal Support Reactions	61
2.2.1	Single-Layer Glass	9	5.6	Max Displacements	62
2.2.2	Laminated Glass	9	5.7	Gas Pressure	63
2.2.3	Insulating Glass	10	5.8	Parts List	63
2.3	Stiffness Matrix	12	<b>6.</b>	<b>Printout</b>	<b>65</b>
2.3.1	2D - Consideration of Shear Coupling Between Layers	12	6.1	Printout Report	65
2.3.2	3D	14	6.2	Printing RF-GLASS Graphics	65
2.3.3	2D - Shear Coupling Between Layers Not Considered	14	6.2.1	Results on the RFEM Model	65
<b>3.</b>	<b>Input Data</b>	<b>17</b>	6.2.2	Results in Layers	67
3.1	General Data	17	<b>7.</b>	<b>General Functions</b>	<b>68</b>
3.1.1	Ultimate Limit State	21	7.1	Units and Decimal Places	68
3.1.2	Serviceability Limit State	22	7.2	Export of Results	69
3.2	Layers	23	7.3	Connection to RFEM	70
3.3	Line Supports	27	<b>8.</b>	<b>Examples</b>	<b>71</b>
3.4	Nodal Supports	31	8.1	Determination of Stiffness Matrix Elements	71
3.5	Boundary Members	34	8.2	Insulating glass	76
3.6	Climatic Load Parameters	35	8.2.1	Calculation in RF-GLASS	77
3.7	Load Duration	37	8.2.2	Check of Calculation	83
3.8	Serviceability Data	38	8.3	Insulating Glass According to TRLV, Annex A	89
<b>4.</b>	<b>Calculation</b>	<b>39</b>	8.4	Curved Insulating Glass	92
4.1	Details	39	8.4.1	Calculation in RF-GLASS	93
4.1.1	Stresses	40	8.4.2	Check of Calculation	99
4.1.2	Results	45	<b>9.</b>	<b>Appendix A</b>	<b>103</b>
4.2	Details of Composition	46	9.1	Stiffness Matrix Check for Positive Definiteness	103
4.3	Standard	49	<b>A</b>	<b>Literature</b>	<b>104</b>
4.3.1	Standard – DIN 18008:2010-12	49	<b>B</b>	<b>Index</b>	<b>105</b>
4.3.2	Standard – TRLV:2006-08	51			

# 1. Introduction

## 1.1 Add-on Module RF-GLASS

The add-on module RF-GLASS from DLUBAL SOFTWARE calculates deformations and stresses of glass surfaces. It allows you to generate all glass types like single layer, laminated, and insulation glass. Furthermore, you can consider shear coupling between the layers.

This module provides an extensive material library containing the common types of glass, foils, and gases. This library includes all essential material parameters according to the standards E DIN EN 13474, DIN 18008-1:2010-12, the technical rules TRLV:2006-08, as well as DIBt approval. Of course, you can also add other materials to the library.

For insulating glass, the calculation considers not only external loads, but also changes of temperature, atmospheric pressure, and altitude that influence an intermediate gas layer. The module also provides a simplified calculation according to Annex A of the standard DIN 18008-1:2010-12 or TRLV:2006-08.

This manual provides all necessary information for working with RF-GLASS. At the end of the manual, you find typical examples for glass design.

Like other modules, RF-GLASS is also fully integrated into RFEM. It is, however, not just an optical part of the main program: Results from the glass calculation, including graphical representations, can be transferred to the RFEM printout report. This allows for an easy and, above all, clearly arranged glass design. The clear layout of the program with its intuitive tables and dialog boxes as well as the uniform structure of the Dlubal add-on modules facilitate working with RF-GLASS.

We hope you will enjoy working with RFEM 5 and RF-GLASS.

Your team from DLUBAL SOFTWARE GMBH

## 1.2 RF-GLASS Team

The following people were involved in the development of RF-GLASS:

### Program coordination

Dipl.-Ing. Georg Dlubal  
 Dipl.-Ing. (FH) Younes El Frem

Ing. Pavel Bartoš

### Programming

Doc. Ing. Ivan Němec, CSc.  
 Mgr. Petr Zajíček

Ing. Lukáš Weis  
 Mgr. Vítězslav Štembera, Ph.D.

### Cross-section and material data base

Ing. Jan Rybín, Ph.D.

### Program design, dialog figures, icons

Dipl.-Ing. Georg Dlubal

MgA. Robert Kolouch

### Program supervision

Mgr. Vítězslav Štembera, Ph.D.  
 Ing. Iva Horčíčková

Dipl.-Ing. (FH) Ulrich Lex

### Manual, help system, and translation

Ing. Iva Horčíčková  
 Mgr. Vítězslav Štembera, Ph.D.  
 Ing. Fabio Borriello  
 Ing. Dmitry Bystrov  
 Eng.º Rafael Duarte  
 Ing. Jana Duníková  
 Ing. Lara Freyer  
 Alessandra Grosso  
 Ing. Chelsea Jennings  
 Jan Jeřábek  
 Ing. Ladislav Kábrt  
 Ing. Aleksandra Kociołek  
 Mgr. Michaela Kryšková

Dipl.-Ing. Tingting Ling  
 Ing. Roberto Lombino  
 Eng.º Nilton Lopes  
 Mgr. Ing. Hana Macková  
 Ing. Téc. Ind. José Martínez  
 MA Translation Anton Mitleider  
 Dipl.-Ü. Gundel Pietzcker  
 Mgr. Petra Pokorná  
 Ing. Zoja Rendlová  
 Dipl.-Ing. Jing Sun  
 Ing. Marcela Svitáková  
 Dipl.-Ing. (FH) Robert Vogl  
 Ing. Marcin Wardyn

### Technical support and quality management

M.Eng. Cosme Asseya  
 Dipl.-Ing. (BA) Markus Baumgärtel  
 Dipl.-Ing. Moritz Bertram  
 M.Sc. Sonja von Bloh  
 Dipl.-Ing. (FH) Steffen Clauß  
 Dipl.-Ing. Frank Faulstich  
 Dipl.-Ing. (FH) René Flori  
 Dipl.-Ing. (FH) Stefan Frenzel  
 Dipl.-Ing. (FH) Walter Fröhlich  
 Dipl.-Ing. Wieland Götzler  
 Dipl.-Ing. (FH) Andreas Hörold  
 Dipl.-Ing. (FH) Paul Kieloch

Dipl.-Ing. (FH) Bastian Kuhn  
 Dipl.-Ing. (FH) Ulrich Lex  
 Dipl.-Ing. (BA) Sandy Matula  
 Dipl.-Ing. (FH) Alexander Meierhofer  
 M. Eng. Dipl.-Ing. (BA) Andreas Niemeier  
 Dipl.-Ing. (FH) Gerhard Rehm  
 M. Eng. Dipl.-Ing. (FH) Walter Rustler  
 M.Sc. Dipl.-Ing. (BA) Frank Sonntag  
 Dipl.-Ing. (FH) Christian Stautner  
 Dipl.-Ing. (FH) Lukas Sühnel  
 Dipl.-Ing. (FH) Robert Vogl

## 1.3 Using the Manual

Topics like system requirements or installation are described in detail in the RFEM manual. Therefore, they do not need to be introduced here. Instead, the present manual focuses on the special features of the add-on module RF-GLASS.

The description of the module keeps to the sequence and structure of the input and output module windows. The text of the manual shows the described **buttons** in square brackets, for example [View mode]. At the same time, they are pictured on the left. In addition, **expressions** used in dialog boxes, tables, and menus are set in *italics* to clarify the explanations.

At the end of the manual, you find an index. However, if you still cannot find what you are looking for, please check our website [www.dlubal.com](http://www.dlubal.com), where you can go through our *FAQ* pages by selecting particular criteria.

## 1.4 Open the RF-GLASS module

There are several possibilities to open the add-on module RF-GLASS.

### Main menu

To open RF-GLASS, select on the RFEM menu

**Add-on Modules → Others → RF-GLASS.**

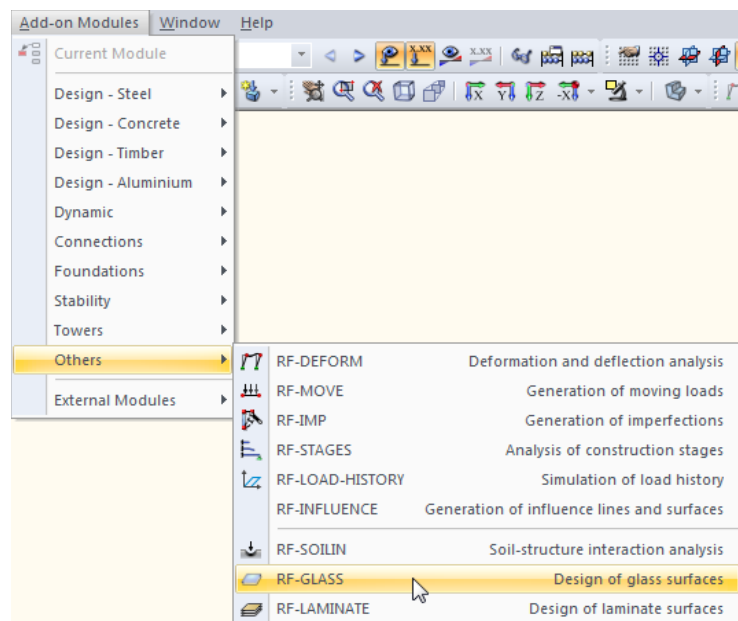

Figure 1.1: Main menu: →Add-on Modules → Others → RF-GLASS

### Navigator

Alternatively, you can start RF-GLASS in the *Data* navigator:

**Add-on Modules → RF-GLASS- Design of glass surfaces.**

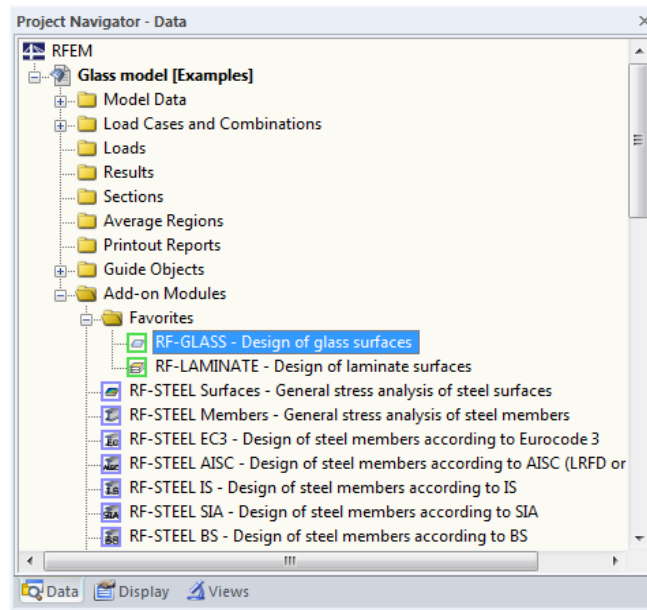

Figure 1.2: Data navigator: Add-on Modules → RF-GLASS

### Panel

If there are already RF-GLASS results in the RFEM model, you can start the add-on module in the panel:

Set the relevant RF-GLASS design case in the load case list, which is located in the RFEM toolbar. Then, click [Show results] to display the deformations or stresses graphically.

In the panel, you can now use the [RF-GLASS] button to open the module.

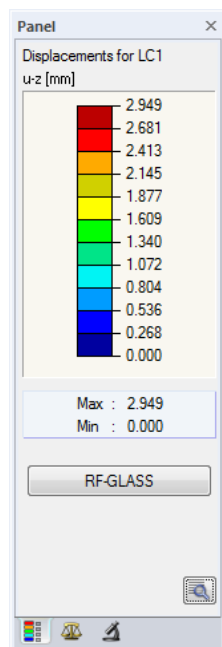
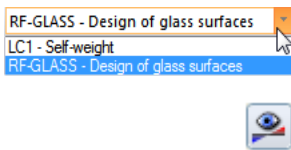

Figure 1.3: Panel button [RF-GLASS]

## 2. Theoretical background

This chapter briefly explains the theoretical principles of the RF-GLASS module.

### 2.1 Symbols

$t$	Thickness of composition [m]
$t_i$	Thickness of individual layers [m]
$E$	Modulus of elasticity [Pa]
$G$	Shear modulus [Pa]
$\nu$	Poisson's ratio [-]
$\gamma$	Specific weight [N/m <sup>3</sup> ]
$\alpha_T$	Coefficient of thermal expansion [1/K]
$\sigma_{\text{limit}}$	Limit stress [Pa]
$\lambda$	Thermal conductivity [W/(mK)]
$d_{ij}$	Elements of the partial stiffness matrix [Pa]
$D_{ij}$	Elements of the global stiffness matrix [Nm, Nm/m, N/m]
$\sigma_x, \sigma_y$	Normal stresses [Pa]
$\tau_{yz}, \tau_{xz}, \tau_{xy}$	Shear stresses [Pa]
$n$	Number of layers [-]
$z$	$z$ -axis coordinate [m]
$T$	Temperature [K]
$p$	Pressure [Pa]
$H$	Altitude [m]
$V$	Volume [m <sup>3</sup> ]
$m_x$	Bending moment inducing stresses in $x$ -axis direction [Nm/m]
$m_y$	Bending moment inducing stresses in $y$ -axis direction [Nm/m]
$m_{xy}$	Torsional moment [Nm/m]
$v_x, v_y$	Shear forces [N/m]
$n_x$	Axial force in $x$ -axis direction [N/m]
$n_y$	Axial force in $y$ -axis direction [N/m]
$n_{xy}$	Shear flow [N/m]



## 2.2 Types of Glass Structures

As already mentioned in the introduction, we distinguish between single layer glass, laminated glass, and insulating glass. Modeling of the different glass types is described in the following chapters.

### 2.2.1 Single-Layer Glass

Single-layer glass is the simplest composition case. For single-layer glass, you can use:

- 2D calculation (plate theory)
- 3D calculation (modeling by using solids)

Calculation according to the plate theory has its limits in the case of plates with an extreme thickness. These are modeled by using solids. An approximation criterion for a valid calculation according to the plate theory is given by the relation  $t/L \leq 0.05$ , where  $t$  is the thickness and  $L$  is the length of the plate side (or the characteristic dimension of the model).

### 2.2.2 Laminated Glass

Laminated glass consists of at least two glass panes, connected by an intermediate layer, which in most cases is made up of a foil or resin.

For laminated glass, you can use:

- 2D calculation with shear coupling between layers (plate theory)
- 3D calculation (modeling by using solids)
- 2D calculation without shear coupling of layers (plate theory)

#### 2D calculation without shear coupling between layers

The stiffness, which is calculated on the basis of the layer composition, is assigned to one or more selected surfaces. The surface is then modeled by using common surface elements.

#### 3D calculation

For laminated glass, the foil connecting individual glass panes is usually much thinner than the glass. The product of the foil thickness and its shear modulus  $t \cdot G$  is about 3-7 decimal places smaller than the product of the glass thickness and the shear modulus of glass. This means that there is a significant shear distortion in glass and foil (see Figure 2.2), and the 2D plate theory yields incorrect results. In this case, it is recommended to use the 3D calculation which yields accurate results, but is more time-consuming.

#### 2D calculation without shear coupling between layers

It is also possible to calculate according to the 2D plate theory without shear coupling between layers. Individual glass panes can then "slide" over each other. This calculation is recommended for long-term loads, when the shear resistance of a connecting foil should not be considered, because its properties depend on the load duration and temperature.

The three mentioned options are shown in Figure 2.1.

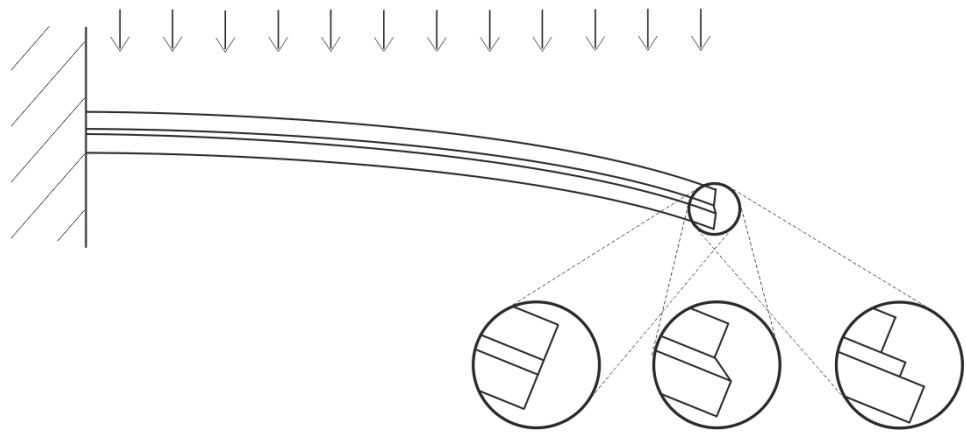

Figure 2.1: Laminated glass subjected to bending: 2D plate theory with shear coupling between layers (left), 3D calculation (middle), 2D plate theory without shear coupling between layers (right)

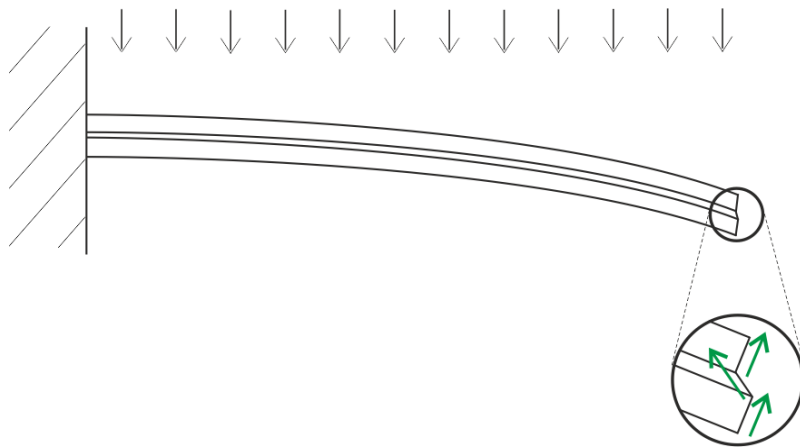

Figure 2.2: Shear distortion in laminated glass (3D calculation)

### 2.2.3 Insulating Glass

This type of glass is always calculated by large deformation analysis, with an application of the NEWTON-RAPHSON method.

Insulating glass consists of individual glass panes, intermediate gas layer, spacer, primary and secondary seal. All these components are essential for the overall behavior of the glass. Besides a composition of individual layers, you can specify properties of the secondary seal and climatic load parameters in RF-GLASS.

Insulating glass is calculated in 3D, therefore all layers are modeled by solids. Consequently, it is only possible to create an insulating glass when the *Local* calculation type is selected (see Chapter 3.1, page 17). A layer of the *Gas* type is modeled by using a solid element, created especially for this calculation. The ideal gas law is then considered in the calculation. Glass is produced at temperature  $T_p$ , pressure  $p_p$ , and initial gas volume  $V_0$  (of a certain intermediate layer).

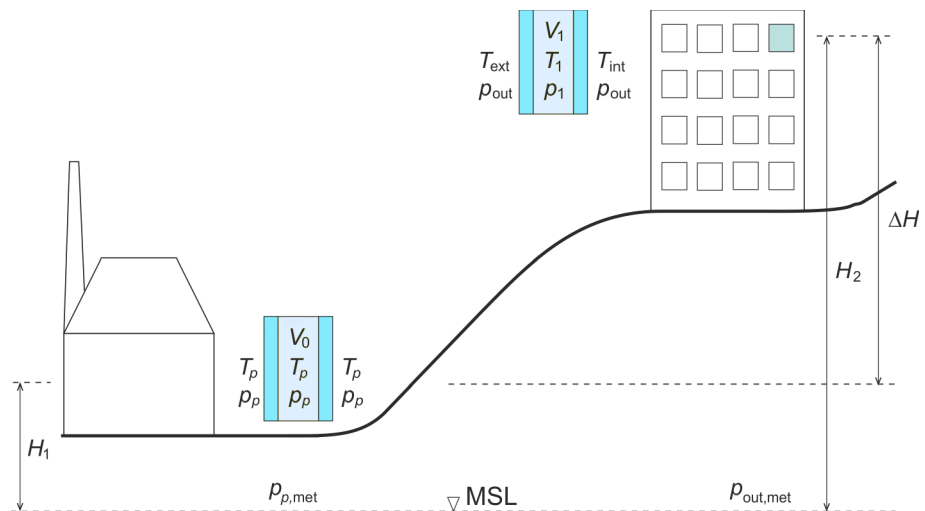

Figure 2.3: Climatic load parameters for manufacturing (left), mount (right), MSL = mean sea level

A load due to a temperature change is converted to a change of an ambient pressure  $p_{out}$  by using the coefficient  $c_1$ . The ambient pressure  $p_{out}$  comprises the atmospheric pressure change converted to the sea level  $\Delta p_{met}$ , the influence of gas heating  $\Delta T$ , and the pressure change due to the altitude  $\Delta H$ . It is determined as follows:

$$p_{out} = p_p + \Delta p_{met} - c_1 \Delta T - c_2 \Delta H \tag{2.1}$$

$$\Delta p_{met} = p_{out,met} - p_{p,met} \tag{2.2}$$

$$\Delta T = T_1 - T_p \tag{2.3}$$

$$\Delta H = H_2 - H_1 \tag{2.4}$$

where

$$c_1 = \frac{p_p}{T_p} \text{ Pa/K} \tag{2.5}$$

$$c_2 = 12 \text{ Pa/m} \tag{2.6}$$

Moreover, the solution satisfies the equilibrium equation

$$p_p V_0 = p_1 V_1 \tag{2.7}$$

$H_1$	Altitude at manufacturing	$p_{p,met}$	Atmospheric pressure at sea level (manufacturing)
$H_2$	Altitude at mount	$p_{out,met}$	Atmospheric pressure at sea level (mount)
$\Delta H$	Difference in altitude $H_2 - H_1$	$p_p$	Pressure during manufacturing
$T_p$	Temperature during manufacturing	$p_{out}$	Ambient pressure during mount
$T_{ext}$	Temperature on the external glass side (mount)	$p_1$	Gas pressure during mount
$T_{int}$	Temperature on the internal glass side (mount)	$V_0$	Initial gas volume
$T_1$	Gas temperature (mount)	$V_1$	Final gas volume

Table 2.1: Symbols for insulating glass

## 2.3 Stiffness Matrix

As an isotropic material, glass is defined by the modulus of elasticity  $E$ , the shear modulus  $G$  and Poisson's ratio  $\nu$ :

$$G = \frac{E}{2 \cdot (1 + \nu)} \quad (2.8)$$

### 2.3.1 2D - Consideration of Shear Coupling Between Layers

Consider a plate consisting of  $n$  isotropic material layers. Each layer has the thickness  $t_i$  and a minimum and maximum  $z$ -coordinate  $z_{\min,i}$ ,  $z_{\max,i}$ .

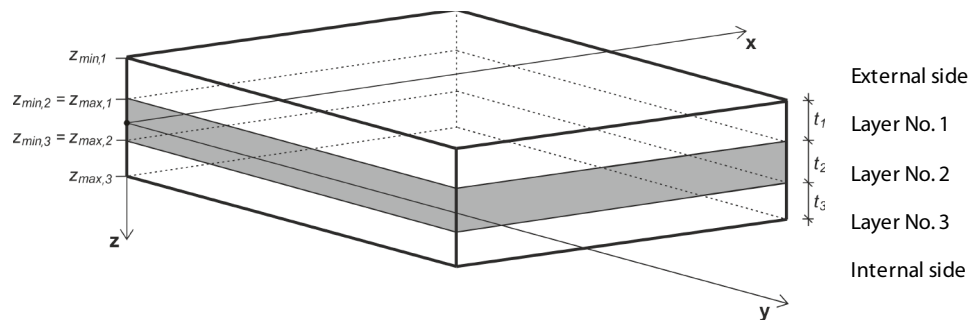

Figure 2.4: Layer composition

The stiffness matrix for each layer  $d_i$  is defined as follows:

$$d_i = \begin{bmatrix} d_{11,i} & d_{12,i} & 0 \\ \text{sym.} & d_{22,i} & 0 \\ & & d_{33,i} \end{bmatrix} = \begin{bmatrix} \frac{E_i}{1-\nu_i^2} & \frac{\nu_i E_i}{1-\nu_i^2} & 0 \\ \frac{E_i}{1-\nu_i^2} & \frac{\nu_i E_i}{1-\nu_i^2} & 0 \\ \text{sym.} & & G_i \end{bmatrix}, \quad G_i = \frac{E_i}{2 \cdot (1 + \nu_i)} \quad i = 1, \dots, n \quad (2.9)$$

The global stiffness matrix is:

$$D = \begin{bmatrix} D_{11} & D_{12} & 0 & 0 & 0 & D_{16} & D_{17} & 0 \\ & D_{22} & 0 & 0 & 0 & \text{sym.} & D_{27} & 0 \\ & & D_{33} & 0 & 0 & \text{sym.} & \text{sym.} & D_{38} \\ & & & D_{44} & 0 & 0 & 0 & 0 \\ & & & & D_{55} & 0 & 0 & 0 \\ & & \text{sym.} & & & D_{66} & D_{67} & 0 \\ & & & & & & D_{77} & 0 \\ & & & & & & & D_{88} \end{bmatrix} \quad (2.10)$$

$$\begin{Bmatrix} m_x \\ m_y \\ m_{xy} \\ v_x \\ v_y \\ n_x \\ n_y \\ n_{xy} \end{Bmatrix} = \begin{bmatrix} D_{11} & D_{12} & 0 & 0 & 0 & D_{16} & D_{17} & 0 \\ & D_{22} & 0 & 0 & 0 & \text{sym.} & D_{27} & 0 \\ & & D_{33} & 0 & 0 & \text{sym.} & \text{sym.} & D_{38} \\ & & & D_{44} & 0 & 0 & 0 & 0 \\ & & & & D_{55} & 0 & 0 & 0 \\ \text{sym.} & & & & & D_{66} & D_{67} & 0 \\ & & & & & & D_{77} & 0 \\ & & & & & & & D_{88} \end{bmatrix} \begin{Bmatrix} \kappa_x \\ \kappa_y \\ \kappa_{xy} \\ \gamma_{xz} \\ \gamma_{yz} \\ \varepsilon_x \\ \varepsilon_y \\ \gamma_{xy} \end{Bmatrix} \quad (2.11)$$

	Bending and torsion
	Shear
	Membrane
	Eccentricity

**Stiffness matrix elements (bending and torsion) [Nm]**

$$\begin{aligned}
 D_{11} &= \sum_{i=1}^n \frac{z_{\max,i}^3 - z_{\min,i}^3}{3} d_{11,i} & D_{12} &= \sum_{i=1}^n \frac{z_{\max,i}^3 - z_{\min,i}^3}{3} d_{12,i} \\
 D_{22} &= \sum_{i=1}^n \frac{z_{\max,i}^3 - z_{\min,i}^3}{3} d_{22,i} & D_{33} &= \sum_{i=1}^n \frac{z_{\max,i}^3 - z_{\min,i}^3}{3} d_{33,i}
 \end{aligned}$$

**Stiffness matrix elements (eccentricity effects) [Nm/m]**

$$\begin{aligned}
 D_{16} &= \sum_{i=1}^n \frac{z_{\max,i}^2 - z_{\min,i}^2}{2} d_{11,i} & D_{17} &= \sum_{i=1}^n \frac{z_{\max,i}^2 - z_{\min,i}^2}{2} d_{12,i} \\
 D_{27} &= \sum_{i=1}^n \frac{z_{\max,i}^2 - z_{\min,i}^2}{2} d_{22,i} & D_{38} &= \sum_{i=1}^n \frac{z_{\max,i}^2 - z_{\min,i}^2}{2} d_{33,i}
 \end{aligned}$$

**Stiffness matrix elements (membrane) [N/m]**

$$\begin{aligned}
 D_{66} &= \sum_{i=1}^n t_i d_{11,i} & D_{67} &= \sum_{i=1}^n t_i d_{12,i} \\
 D_{77} &= \sum_{i=1}^n t_i d_{22,i} & D_{88} &= \sum_{i=1}^n t_i d_{33,i}
 \end{aligned}$$

Stiffness matrix elements (shear) [N/m]

$$D_{44} = D_{55} = \max \left( D_{44/55, \text{calc}}, \frac{48}{5l^2} \frac{1}{\sum_{i=1}^n E_i \frac{t_i^3}{12}} \frac{1}{\sum_{i=1}^n E_i \frac{z_{\max,i}^3 - z_{\min,i}^3}{3}} \right) \quad (2.12)$$

where  $l$  is the middle size of the surface bounding box. The value  $D_{44/55, \text{calc}}$  is given by:

$$D_{44/55, \text{calc}} = \frac{1}{\int_{-t/2}^{t/2} G(z) \left( \frac{\int_{-t/2}^z d_{11}(\bar{z})(\bar{z}-z_0) d\bar{z}}{\int_{-t/2}^{t/2} d_{11}(\bar{z})(\bar{z}-z_0)^2 d\bar{z}} \right)^2 dz}, \quad z_0 = \frac{-t/2}{\int_{-t/2}^{t/2} d_{11}(\bar{z}) d\bar{z}}, \quad t = \sum_{i=1}^n t_i \quad (2.13)$$

2.3.2 3D

If the model is created by means of solids, the following stiffness matrix is used:

$$\begin{Bmatrix} \sigma_x \\ \sigma_y \\ \sigma_z \\ \tau_{yz} \\ \tau_{xz} \\ \tau_{xy} \end{Bmatrix} = \begin{bmatrix} \frac{1}{E} & -\frac{\nu}{E} & -\frac{\nu}{E} & 0 & 0 & 0 \\ & \frac{1}{E} & -\frac{\nu}{E} & 0 & 0 & 0 \\ & & \frac{1}{E} & 0 & 0 & 0 \\ & & & \frac{1}{G} & 0 & 0 \\ & & & & \frac{1}{G} & 0 \\ & \text{sym.} & & & & \frac{1}{G} \end{bmatrix}^{-1} \begin{Bmatrix} \varepsilon_x \\ \varepsilon_y \\ \varepsilon_z \\ \gamma_{yz} \\ \gamma_{xz} \\ \gamma_{xy} \end{Bmatrix}, \quad G = \frac{E}{2 \cdot (1 + \nu)} \quad (2.14)$$

2.3.3 2D - Shear Coupling Between Layers Not Considered

Now, consider a plate consisting of  $n$  isotropic materials without shear coupling of the individual layers. Each layer has the thickness  $t_i$  and a minimum and maximum  $z$ -coordinate  $z_{\min,i}, z_{\max,i}$ .

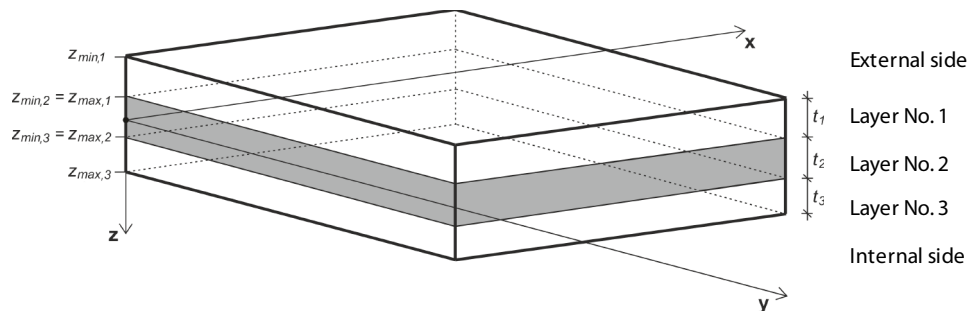

Figure 2.5: Layer composition

The stiffness matrix for each layer  $d_i$  is determined as follows:

$$d_i = \begin{bmatrix} d_{11,i} & d_{12,i} & 0 \\ & d_{22,i} & 0 \\ \text{sym.} & & d_{33,i} \end{bmatrix} = \begin{bmatrix} \frac{E_i}{1-\nu_i^2} & \frac{\nu_i E_i}{1-\nu_i^2} & 0 \\ & \frac{E_i}{1-\nu_i^2} & 0 \\ \text{sym.} & & G_i \end{bmatrix}, \quad G_i = \frac{E_i}{2 \cdot (1 + \nu_i)} \quad i=1, \dots, n \quad (2.15)$$

The global stiffness matrix is:

$$D = \begin{bmatrix} D_{11} & D_{12} & 0 & 0 & 0 & 0 & 0 & 0 \\ & D_{22} & 0 & 0 & 0 & 0 & 0 & 0 \\ & & D_{33} & 0 & 0 & 0 & 0 & 0 \\ & & & D_{44} & 0 & 0 & 0 & 0 \\ & & & & D_{55} & 0 & 0 & 0 \\ & \text{sym.} & & & & D_{66} & D_{67} & 0 \\ & & & & & & D_{77} & 0 \\ & & & & & & & D_{88} \end{bmatrix} \quad (2.16)$$

$$\begin{bmatrix} m_x \\ m_y \\ m_{xy} \\ v_x \\ v_y \\ n_x \\ n_y \\ n_{xy} \end{bmatrix} = \begin{bmatrix} D_{11} & D_{12} & 0 & 0 & 0 & 0 & 0 & 0 \\ & D_{22} & 0 & 0 & 0 & 0 & 0 & 0 \\ & & D_{33} & 0 & 0 & 0 & 0 & 0 \\ & & & D_{44} & 0 & 0 & 0 & 0 \\ & & & & D_{55} & 0 & 0 & 0 \\ & \text{sym.} & & & & D_{66} & D_{67} & 0 \\ & & & & & & D_{77} & 0 \\ & & & & & & & D_{88} \end{bmatrix} \begin{bmatrix} \kappa_x \\ \kappa_y \\ \kappa_{xy} \\ \gamma_{xz} \\ \gamma_{yz} \\ \varepsilon_x \\ \varepsilon_y \\ \gamma_{xy} \end{bmatrix} \quad (2.17)$$

	Bending and torsion
	Shear
	Membrane

**Stiffness matrix elements (bending and torsion) [Nm]**

$$D_{11} = \sum_{i=1}^n \frac{t_i^3}{12} d_{11,i}$$

$$D_{12} = \sum_{i=1}^n \frac{t_i^3}{12} d_{12,i}$$

$$D_{22} = \sum_{i=1}^n \frac{t_i^3}{12} d_{22,i}$$

$$D_{33} = \sum_{i=1}^n \frac{t_i^3}{12} d_{33,i}$$

### Stiffness matrix elements (membrane) [N/m]

$$D_{66} = \sum_{i=1}^n t_i d_{11,i}$$

$$D_{67} = \sum_{i=1}^n t_i d_{12,i}$$

$$D_{77} = \sum_{i=1}^n t_i d_{22,i}$$

$$D_{88} = \sum_{i=1}^n t_i d_{33,i}$$

### Stiffness matrix elements (shear) [N/m]

$$D_{44} = \sum_{i=1}^n \frac{5}{6} G_{11,i} t_i$$

$$D_{55} = \sum_{i=1}^n \frac{5}{6} G_{22,i} t_i$$



## 3. Input Data

When you start RF-GLASS, a new window appears. The navigator on the left side contains the available module windows.

The design-relevant data is to be defined in several input windows.

To open a module window, click the appropriate item in the navigator. To select the previous or next window, use the buttons shown on the left. To browse through the windows, you can use the keys [F2] (next) and [F3] (previous).



Calculation

Details...

Standard

Graphics

OK

Cancel

Having entered all necessary data, you can start the [Calculation].

By clicking [Details], you open the dialog box where you can specify the stresses and results windows to be displayed (see Chapter 4.1, page 39).

To set the limit deflections and other calculation parameters, click [Standard].

To display the RFEM work window, click [Graphics].

To save the entered data and exit RF-GLASS, click [OK]. To exit the module without saving the entered data, click [Cancel].

### 3.1 General Data

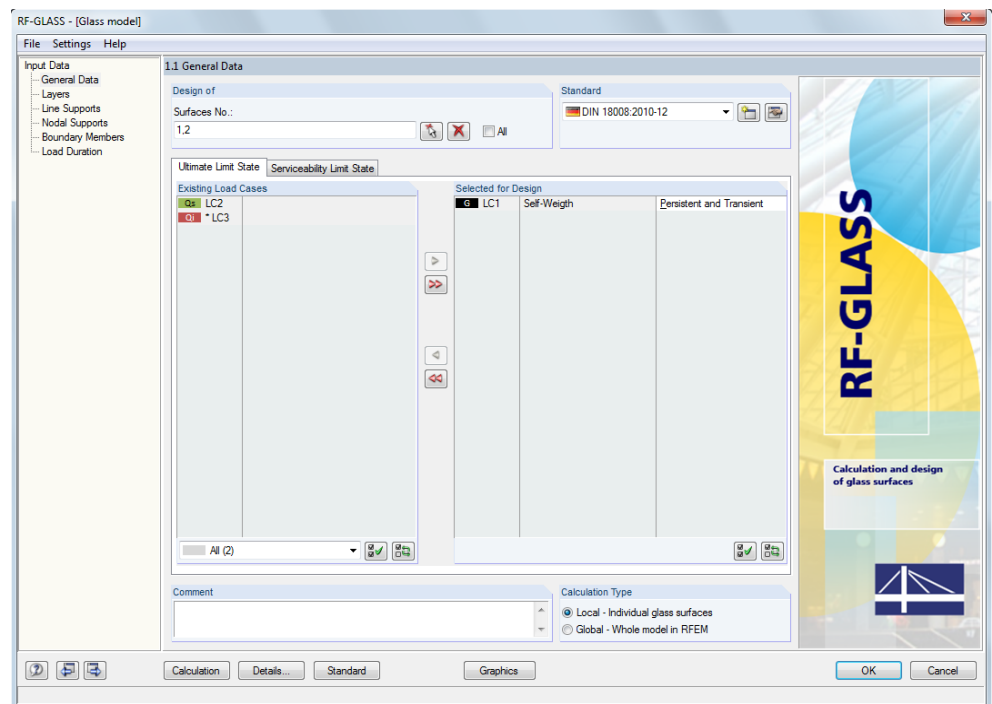

Figure 3.1: Window 1.1 *General Data*

In Window 1.1 *General Data*, you select the surfaces and actions for the design. You can select load cases, load combinations, or result combinations for the ultimate limit state design and the serviceability limit state design in the two respective tabs.

### Design of

In the upper section, you specify the surfaces for the design. If you want to analyze only particular surfaces, clear the selection of the *All* check box: Thus, an input field becomes available where you can enter the relevant surfaces. You can select the list of the preset numbers by double-clicking it, and then overwrite the entry manually. The [ $\wedge$ ] button allows you to graphically select the surfaces in the RFEM work window. You can delete the list of the already preset surface numbers by clicking [X].



### Standard

In the Item list in the upper right corner of the window, you can select the standard from which the parameters will be applied for the design and the limit values of the deflection.

The following standards can be selected:

- DIN 18008:2010-12
- TRLV:2006-08
- None

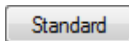

Use the [Edit] button to open a dialog box where you can check and, if necessary, adjust the parameters of the selected standard. The dialog box is described in Chapter 4.3 on page 49.

To create a user-defined standard, click [Create new standard...].

In addition to that, you can click the [Standard] button from all windows. This button also allows you to open the *Standard* dialog box.

### Calculation type

In the section *Calculation type*, you can choose:

- *Local - Individual glass surfaces*
- *Global - Whole model in RFEM*

If you select *Local - Individual glass surfaces*, the calculation of the selected surfaces in RF-GLASS is done in independent systems. The surfaces are analyzed separately, without interaction with the model created in RFEM. Line supports, nodal supports and boundary members can be set directly in Windows 1.3, 1.4 and 1.5 of the module. The supports and members entered in RF-GLASS are considered only in the module; they do not influence RFEM specifications. For this selection, 3D calculation (using 3D finite elements) of glass surfaces is possible.

If you select *Global - Whole model in RFEM*, the calculation proceeds directly with the model created in RFEM. Therefore, it is not necessary to define supports and boundary members directly in RF-GLASS. Consequently, Windows 1.3, 1.4 and 1.5 are not available with this option (as you can see in Figure 3.2). If the *Global* calculation type is selected, only 2D calculation (plate theory) is possible. It is not possible to create insulating glass (set gas layer in Table 1.2) which is always modeled by solid elements (see Chapter 2.2.3, page 10).

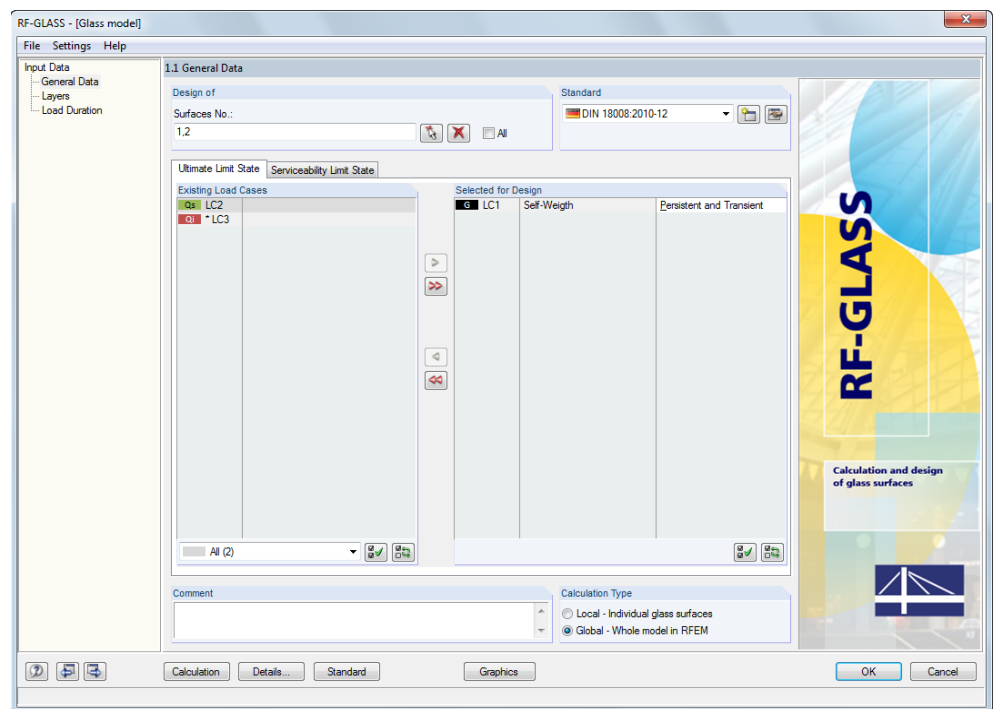

Figure 3.2: Window 1.1 *General Data* – *Global* calculation type

The following example shows how the model in RFEM and the *Calculation type* in RF-GLASS significantly influences the RF-GLASS calculation. Consider the glass structure in the following picture.

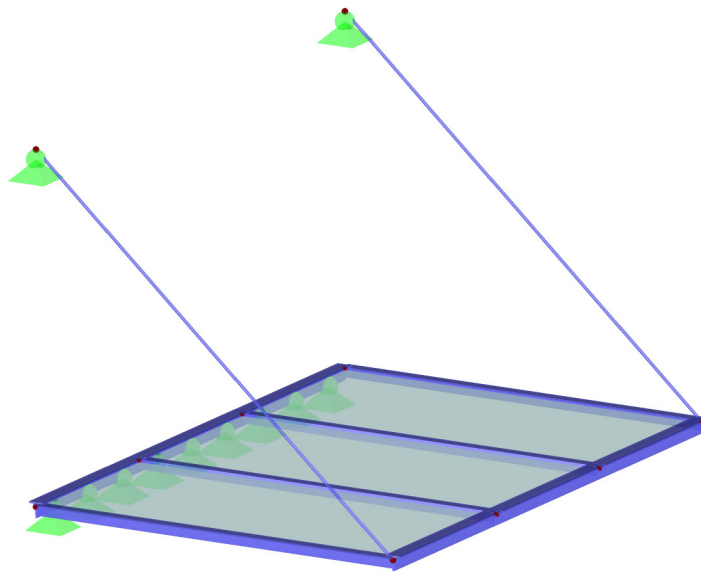

Figure 3.3: RFEM model

- The model is created as one surface. Then, two lines with members are inserted. *Local calculation of individual glass surfaces* is selected in RF-GLASS. The model used for the calculation is in the following picture.

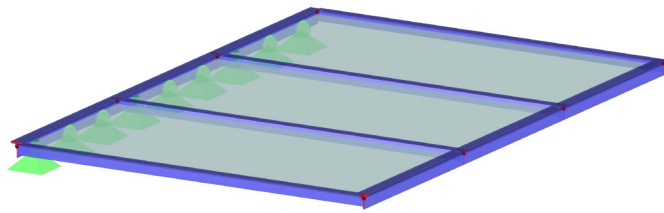

Figure 3.4: RF-GLASS model with one surface of the type *Glass* and *Local calculation of individual glass surfaces*

- This example can also be modeled in RFEM with three surfaces. However, in this case three separate models are created in RF-GLASS – see Figure 3.5, Figure 3.6 and Figure 3.7. You can see that supports or members that are created on common lines or nodes (in this case member) are valid for both surfaces.

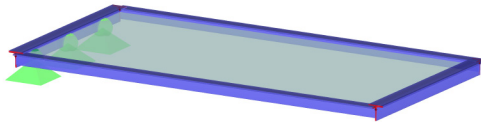

Figure 3.5: Model of surface No. 1 in RF-GLASS in the case of three surfaces of the type *Glass* and *Local calculation of individual glass surfaces*

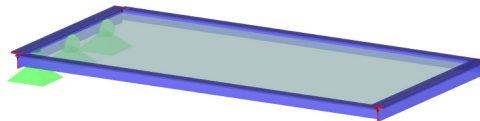

Figure 3.6: Model of surface No. 2 in RF-GLASS in the case of three surfaces of the type *Glass* and *Local calculation of individual glass surfaces*

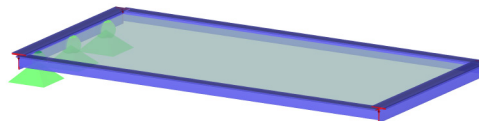

Figure 3.7: Model of surface No. 3 in RF-GLASS in the case of three surfaces of the type *Glass* and *Local calculation of individual glass surfaces*

- If *Global calculation with whole model in RFEM* is selected, calculation is done with the same model as in RFEM.

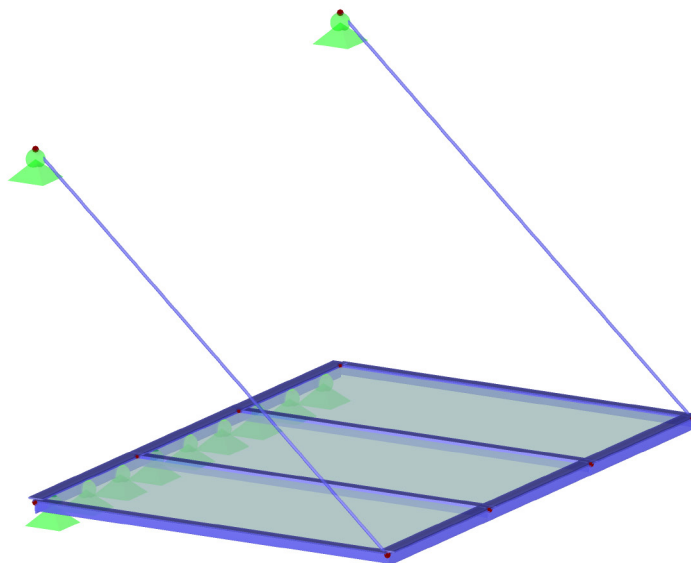

Figure 3.8: Model in the case of *Global calculation with whole structure in RFEM*

### Comment

This comment text box is located at the bottom of the window. You can enter notes or explanations for the RF-GLASS case.

### 3.1.1 Ultimate Limit State

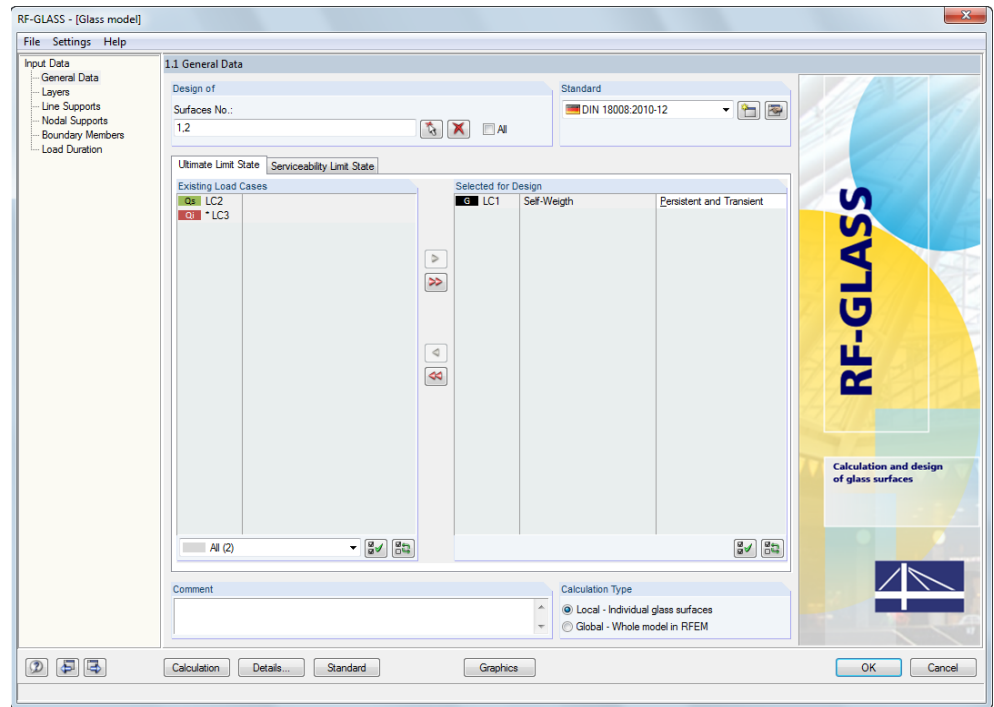

Figure 3.9: Window 1.1 *General Data*, tab *Ultimate Limit State*

#### Existing Load Cases

This section contains the list of all load cases, load combinations, and result combinations created in RFEM.



By using the [▶] button, you can transfer selected entries to the list *Selected for Design* on the right. You can also transfer items by double-clicking them. To transfer the entire list to the right, click [▶▶].



You can also make a multiple selection of load cases by pressing the [Ctrl] key and clicking the respective items, as is usual in Windows. In this way, you can select and transfer several load cases to the list on the right at once.

If a load case or load combination is marked with an asterisk (\*), as for example LC3 in Figure 3.9, you cannot design it: This indicates a load case without load data or an imperfection load case. However, this does not apply to insulating glass: This type of glass can also be loaded by a change of temperature, atmospheric pressure, or altitude (see Chapter 3.6, page 35). If at least one gas layer is defined in the 1.2 *Layers* window, the asterisk (\*) disappears in the 1.1 *General Data* window at the load case without the assigned load data so that you can select it for the design.

Filter options are available at the bottom of the list. These options make it easier to assign the entries sorted by load cases, load combinations, or action categories. The buttons have the following functions:



	Selects all load cases in the list
	Inverts the selection of load cases

Table 3.1: Buttons in the tab *Ultimate Limit State*



Because the calculation of insulating glass always proceeds by the large deformation analysis, it is not possible to calculate result combinations for insulating glass.

### Selected for Design

The right part of the module window lists the load cases, load combinations, and result combinations selected for design. To remove the selected items from the list, click [◀] or double-click them. To transfer the entire list to the left, click [◀◀].



You can assign the load cases, load combinations, and result combinations to the following design situations:

- *Persistent and transient*
- *Accidental*

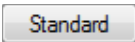

This classification manages the partial safety factor  $\gamma_M$  of the material properties. You can check and adjust this factor in the *Standard* dialog box (see Chapter 4.3).

## 3.1.2 Serviceability Limit State

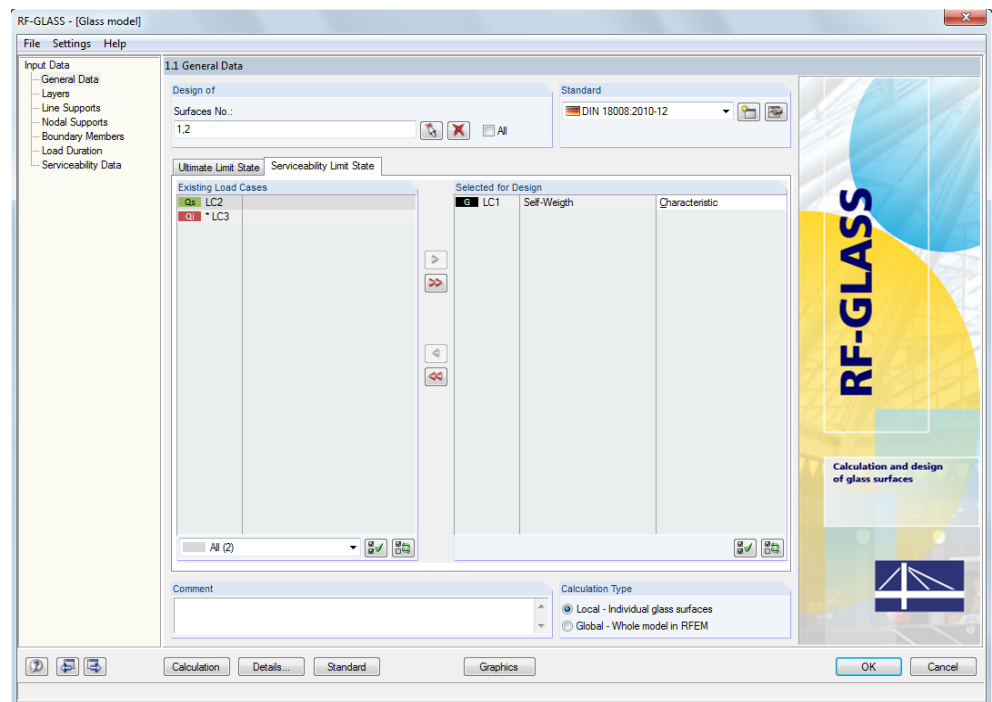

Figure 3.10: Window 1.1 *General Data*, tab *Serviceability Limit State*

### Existing Load Cases

This section lists all load cases, load combinations, and result combinations, which were created in RFEM. After you transfer items to the *Selected for Design* list on the right, the additional window 1.8 *Serviceability Data* appears in the navigator.

### Selected for Design

As described in Chapter 3.1.1, you can add or remove load cases, load combinations, and result combination.

In this section, you assign a design situation to the individual load cases, load combinations, and result combinations, either *Characteristic*, *Frequent*, or *Quasi-permanent*. Based on this selection, different limit values apply for the deflection. You can adjust these limit values in the *Standard* dialog box (see Chapter 4.3).



## 3.2 Layers

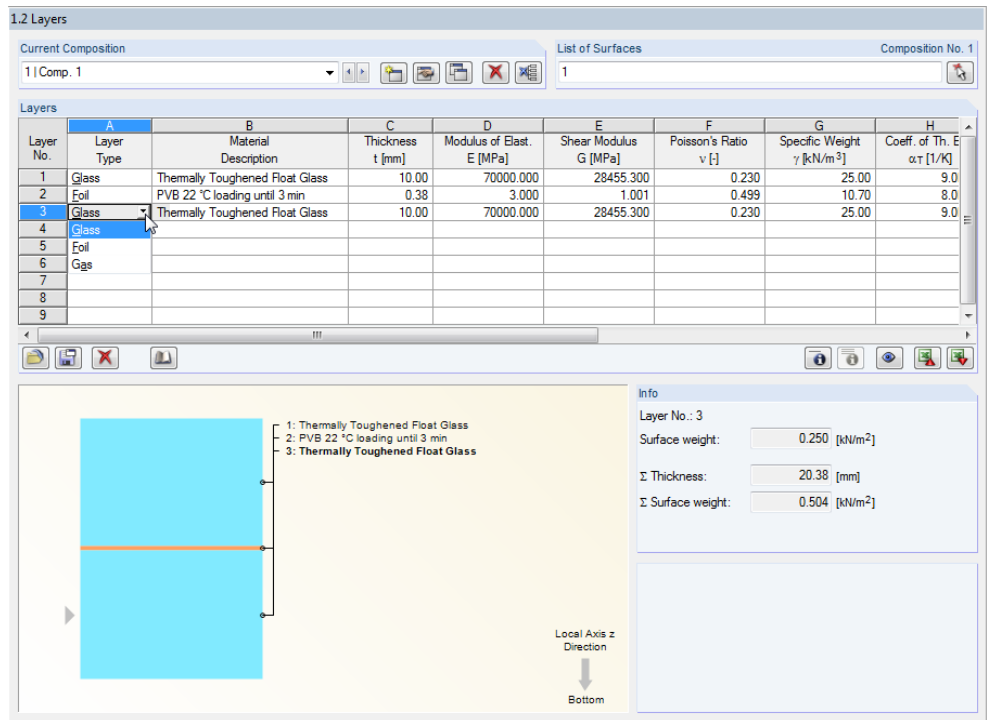

Figure 3.11: Window 1.2 Layers

In this window, you define layer compositions for individual surfaces of a glass structure. The selected composition is displayed in the *Current Composition* section. You can specify individual layers for each composition. You can create more compositions with various layers here. For each composition, you need to define corresponding surfaces in the section *List of Surfaces*.

The following buttons are available in this window:







Button	Name
	Create New Composition
	Edit Composition Details...
	Copy Current Composition
	Delete Current Composition
	Delete All Compositions
	Select Surfaces

Table 3.1: Buttons in the Layers window



For each composition, the *Details of Composition* dialog box is available. To open the dialog box, which is described in Chapter 4.2, click [Edit Composition Details...].

In Window 1.2 *Layers*, in the *Layers* section, you can define individual layers for the current composition. Column A *Layer Type* provides the three options **Glass**, **Foil**, and **Gas**.

You can select the materials from the library, which already contains a large number of materials. To open the material library, click the button shown on the left. You can also place the cursor in the relevant field of column B *Material Description*, and then click the appearing [...] button or press [F7].

In the *Filter* section of the material library (see Figure 3.4), the material category appropriate for the layer type selected in column A is preset.

You can reduce the selection possibilities of materials by using the drop-down lists *Standard group* or *Standard*. In the *Material to Select* list on the right, you can select a material and check its parameters in the lower part of the dialog box.

To import a material in the 1.2 *Layers* window, click [OK]. Alternatively, you can press [...] or double-click the material. Then, you can adjust all material parameters directly in the module.

B
Material Description
Thermally Toughened Float Glass
PVB 22 °C loading until 3 min
Thermally Toughened Float Glass

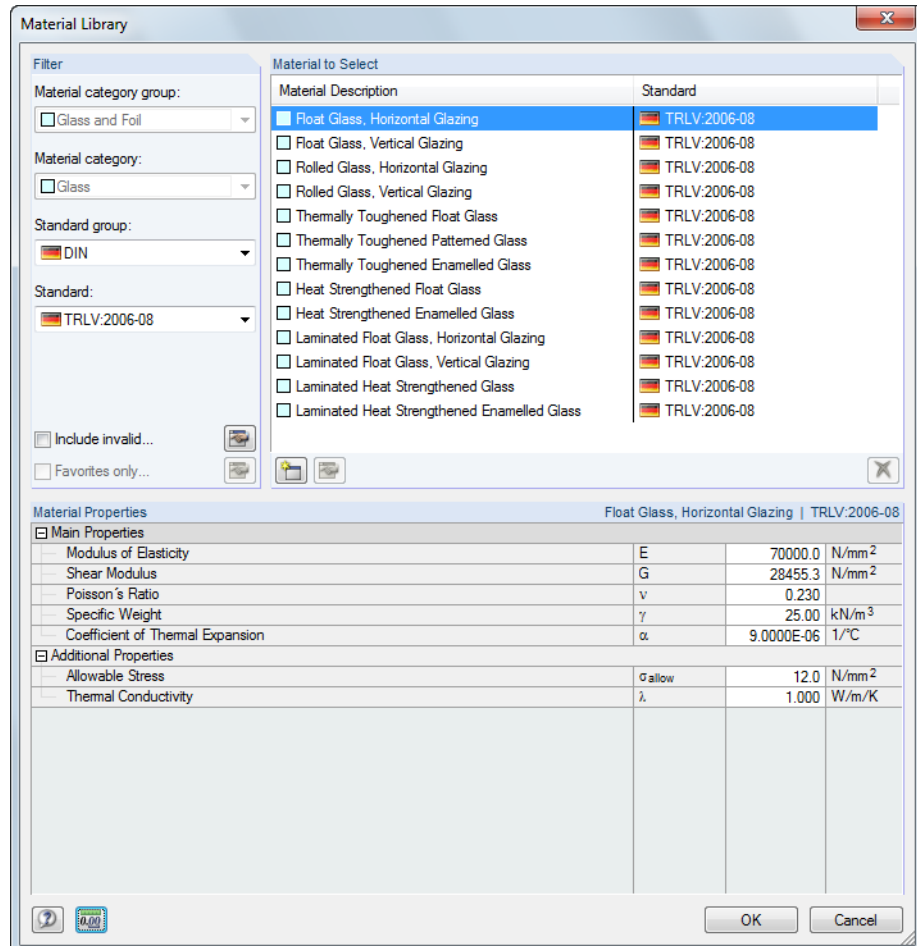

Figure 3.12: Material library

For the TRLV regulation (Technical regulation for the use of glazing with linear supports), the material library distinguishes between vertical and horizontal glazing. The following figure illustrates the difference. For glass types that are not distinguished in such a way, the parameters are the same for both glazing types.



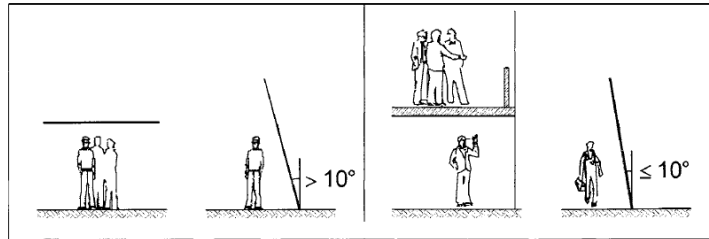

Figure 3.13: Horizontal glazing (left), vertical glazing (right) [6]

Individual layers can have a solid (glass or foil) or a gaseous state. If a composition contains a gas layer (that is, for insulating glass), then the program shows which side is considered as the external and which as the internal one (see Figure 3.14). This piece of information is important for entering further parameters in the 1.6 *Climatic Load Parameters* window. This module window appears in the navigator if you specify a gas layer (see Chapter 3.6, page 35).



A gas layer must always be enclosed on both sides by layers of a solid material (glass or foil).

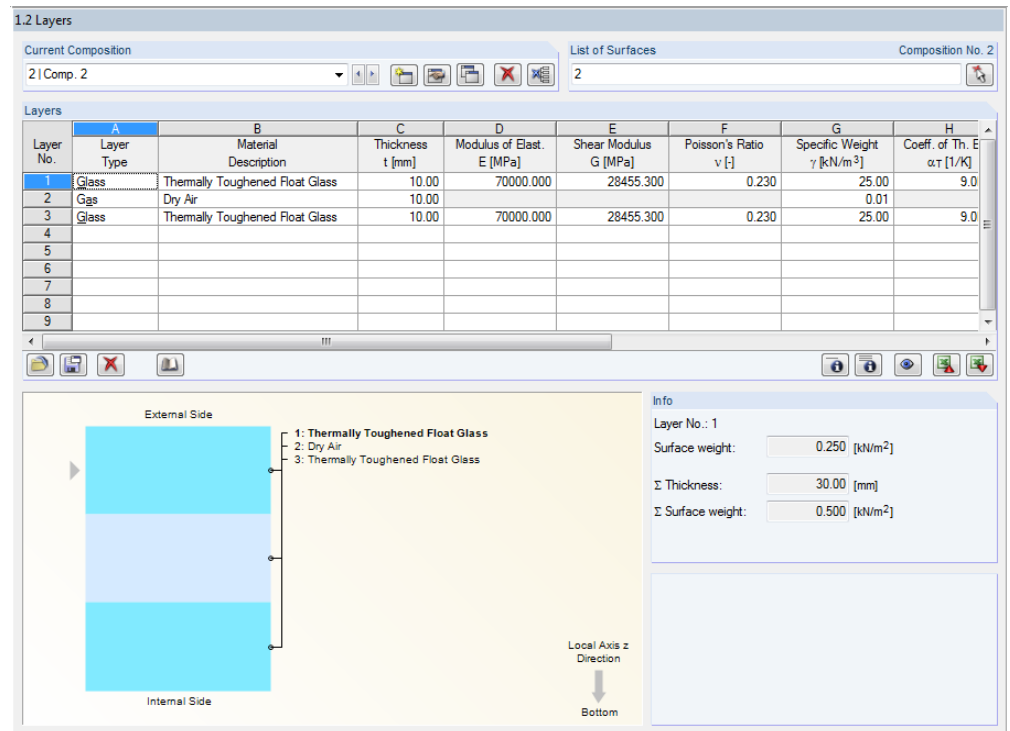





Figure 3.14: Window 1.2 *Layers* – insulated glass

Below the table in Window 1.2, you can find a number of useful buttons. The buttons have the following functions:

Button	Name	Function
	Load saved layers	Loads a previously saved composition
	Save layers as	Saves the composition entered in Window 1.2 which can then be loaded in other RF-GLASS models
	Delete all layers	Deletes all data in Window 1.2.
	Import material from library	Opens the dialog box <i>Material Library</i>





	Show layer stiffness matrix elements	Displays elements of the stiffness matrix (see Chapter 2.3, page 12).
	Show extended stiffness matrix elements	Displays elements of the global stiffness matrix (see Chapter 2.3, page 12).
	Jump to graphic to change view	Jumps to the RFEM user interface allowing for a graphical evaluation without exiting RF-GLASS
	Export to MS Excel/ OpenOffice.org Calc	Exports contents of a current module window to MS Excel or OpenOffice.org Calc → Chapter 7.2, page 69
	Import from Microsoft Excel/ OpenOffice.org Calc	Imports contents of a MS Excel or OpenOffice.org Calc table to Window 1.2

Table 3.2: Button in Window 1.2 *Layers*

In the lower right part of the 1.2 *Layers* window, you can find information on the weight of the selected layer as well as the total thickness and weight of a model.

### 3.3 Line Supports

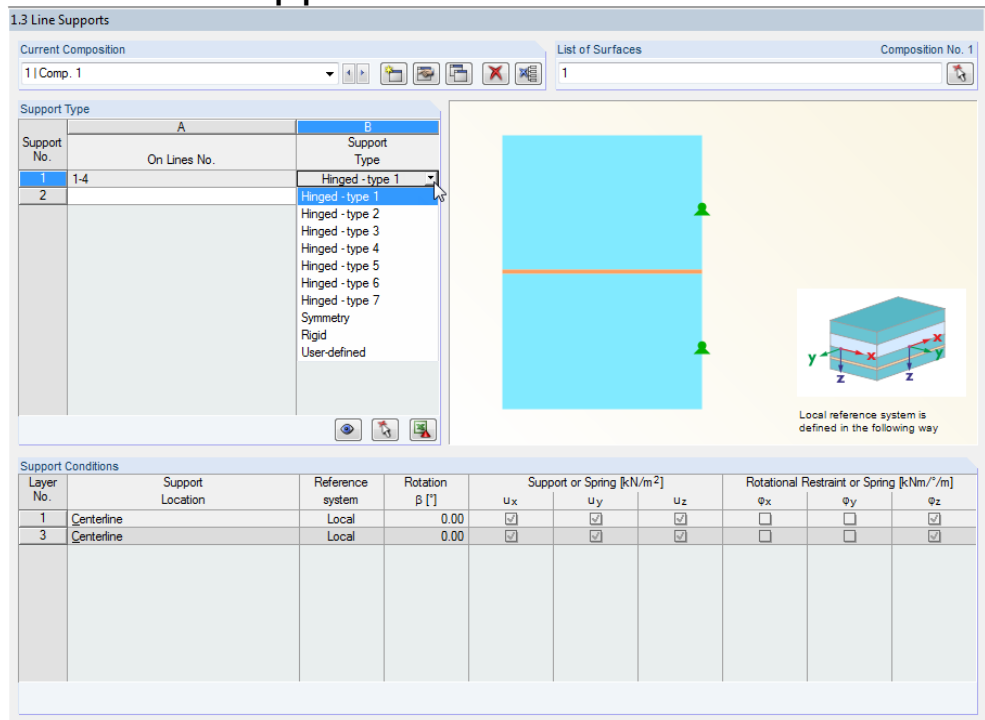

Figure 3.15: Window 1.3 Line Supports

If you select the *Local* calculation in Window 1.1, the analysis in RF-GLASS requires a precise structural model. To this end, you can choose from nine types of predefined line supports or define your own type. The supports entered in RF-GLASS are used only for this module; they do not influence RFEM specifications.

In column A *On Lines No.*, you specify the lines at which the support acts. In column B, you can select a standard *Support Type* (*Hinged - type 1* through *type 7*, *Symmetry*, and *Rigid*), or specify a user-defined support. The user-defined support is to be specified in the lower table of this window. A dynamic graphic shows the locations of the line supports on the layers, allowing you to check your entries. All predefined line supports are related to the local coordinate system that is defined for RF-GLASS in the following way: Axis *x* is the center line of the selected line, axis *y* is in the plane of a surface defined in RFEM, and axis *z* is perpendicular to the RFEM surface.

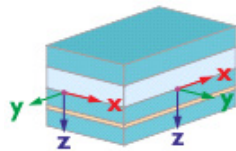

Figure 3.16: Local coordinate system of RF-GLASS



For laminated glass, there is a difference between 2D and 3D calculation with regard to boundary conditions for predefined line supports of the type *Hinged* (type 1, 3, 5, 7). If the calculation is in 2D (according to the plate theory), the supports are hinged. In the 3D calculation, however (solid model), the supports are partially rigid. The following figure illustrates the difference:

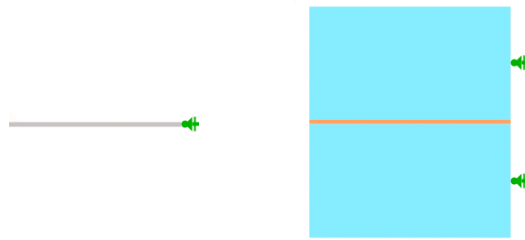
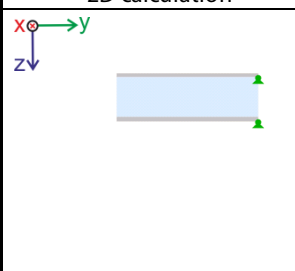
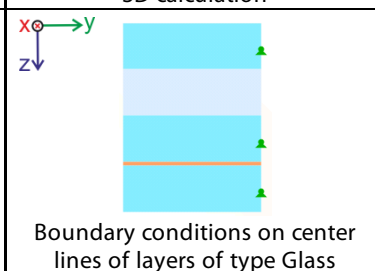
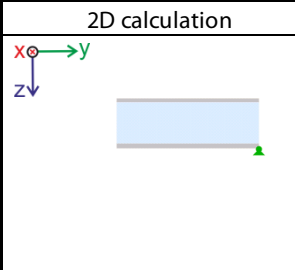
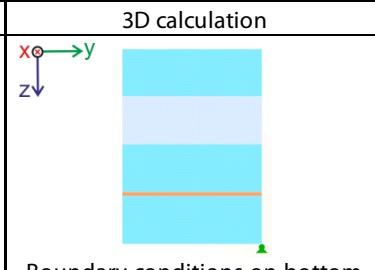
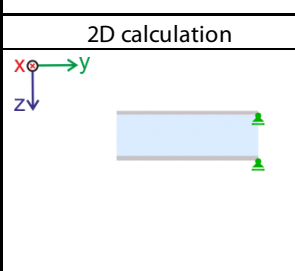
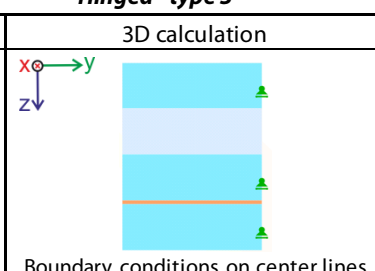
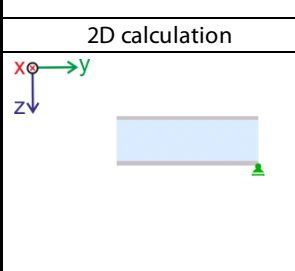
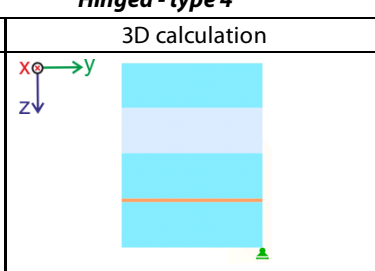

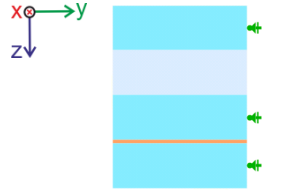

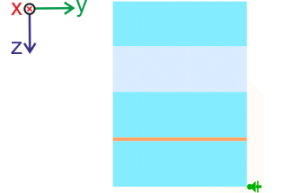

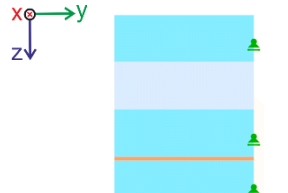

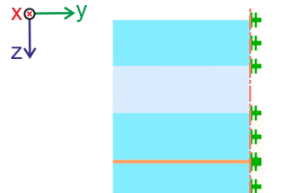

Figure 3.17: Line supports of the type *Hinged - type 5*: 2D calculation (left) and 3D calculation (right)

The predefined support types are explained in the following table:

<b>Hinged - type 1</b>		
2D calculation	3D calculation	Boundary conditions
	 <p>Boundary conditions on center lines of layers of type Glass</p>	$u_x = u_y = u_z = 0$ $\varphi_z = 0$
<b>Hinged - type 2</b>		
2D calculation	3D calculation	Boundary conditions
	 <p>Boundary conditions on bottom edge of lowest layer of type Glass</p>	$u_x = u_y = u_z = 0$ $\varphi_z = 0$
<b>Hinged - type 3</b>		
2D calculation	3D calculation	Boundary conditions
	 <p>Boundary conditions on center lines of layers of type Glass</p>	$u_z = 0$ $\varphi_z = 0$
<b>Hinged - type 4</b>		
2D calculation	3D calculation	Boundary conditions
	 <p>Boundary conditions on bottom edge of lowest layer of type Glass</p>	$u_z = 0$ $\varphi_z = 0$

<b>Hinged - type 5</b>		
2D calculation	3D calculation	Boundary conditions
	 <p>Boundary conditions on center lines of layers of type Glass</p>	$u_x = u_y = 0$ $\varphi_z = 0$
<b>Hinged - type 6</b>		
2D calculation	3D calculation	Boundary conditions
	 <p>Boundary conditions on bottom edge of lowest layer of type Glass</p>	$u_x = u_y = 0$ $\varphi_z = 0$
<b>Hinged - type 7</b>		
2D calculation	3D calculation	Boundary conditions
	 <p>Boundary conditions on center lines of layers of type Glass</p>	$u_x = u_z = 0$ $\varphi_y = \varphi_z = 0$
<b>Symmetry</b>		
<p>This boundary condition is recommended for cases when you want to use the symmetry of a model. The condition contains not only correct line supports but also an appropriate material of the side surface, which does not cause stiffening of the model.</p>		
2D calculation	3D calculation	Boundary conditions
	 <p>Boundary conditions on all lines of all layers</p>	$u_y = 0$ $\varphi_x = \varphi_z = 0$

<i>Rigid</i>		
2D calculation	3D calculation	Boundary conditions
	 <p>Boundary conditions on all lines of all layers</p>	$u_x = u_y = u_z = 0$ $\varphi_x = \varphi_y = \varphi_z = 0$

Table 3.3: Predefined types of line supports

User-defined supports can be entered in the lower table (see Figure 3.15) – for glass layers which contain the lines of this table. In this table, you select the *Support Location* and define the *Reference System*. You can choose either the local coordinate system of RF-GLASS (can be defined directly in the table) or the global coordinate system. Furthermore, you can specify a rotation of the local coordinate system about axis  $x$  with the angle  $\beta$  and define individual degrees of freedom.

As for the predefined supports, a graphic illustrates the selected lines with the chosen line supports.

In Window 1.3, three buttons are available, which have the following functions:

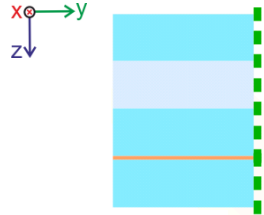

Button	Name	Function
	View mode	Jumps to the RFEM work window for a graphical check without exiting RF-GLASS
	Graphical selection	Allows you to graphically select a line in the RFEM work window
	MS Excel	Exports contents of a current window to MS Excel or OpenOffice.org Calc (→ Chapter 7.2, page 69)

Table 3.4: Buttons in the window *Line Supports*

### 3.4 Nodal Supports

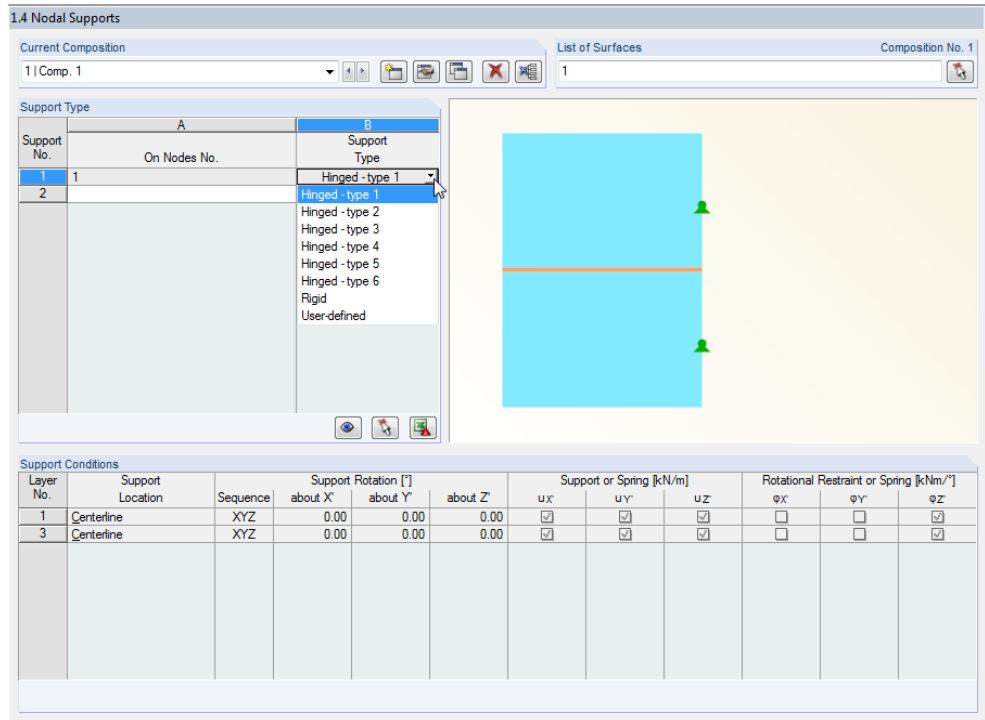
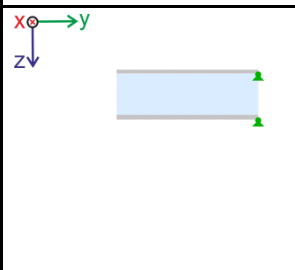
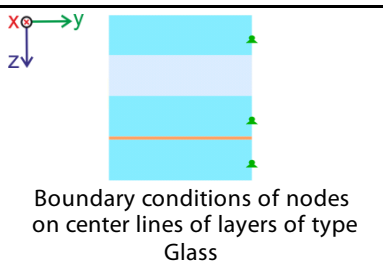
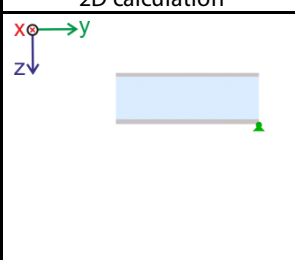
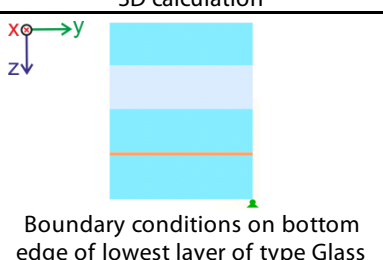

Figure 3.18: Window 1.4 Nodal Supports

In this module window, you can define nodal supports. In column A *On Nodes No.*, you select the nodes, at which the support acts. In column B, you can select a standard *Support Type* (*Hinged - type 1 to type 6, Rigid*), or a user-defined support. The user-defined support is to be specified in the lower table. A dynamic graphic shows the exact locations of the nodal supports at the individual layers, allowing you to check your entries.

The predefined support types are explained in the following table:

<b>Hinged - type 1</b>		
2D calculation	3D calculation	Boundary conditions
	 <p>Boundary conditions of nodes on center lines of layers of type Glass</p>	$u_x = u_y = u_z = 0$ $\varphi_z = 0$
<b>Hinged - type 2</b>		
2D calculation	3D calculation	Boundary conditions
	 <p>Boundary conditions on bottom edge of lowest layer of type Glass</p>	$u_x = u_y = u_z = 0$ $\varphi_z = 0$











<b>Hinged - type 3</b>		
2D calculation	3D calculation	Boundary conditions
	 <p>Boundary conditions of nodes on center lines of layers of type Glass</p>	$u_z = 0$ $\varphi_z = 0$
<b>Hinged - type 4</b>		
2D calculation	3D calculation	Boundary conditions
	 <p>Boundary conditions on bottom edge of lowest layer of type Glass</p>	$u_z = 0$ $\varphi_z = 0$
<b>Hinged - type 5</b>		
2D calculation	3D calculation	Boundary conditions
	 <p>Boundary conditions of nodes on center lines of layers of type Glass</p>	$u_x = u_y = 0$ $\varphi_z = 0$
<b>Hinged - type 6</b>		
2D calculation	3D calculation	Boundary conditions
	 <p>Boundary conditions on bottom edge of lowest layer of type Glass</p>	$u_x = u_y = 0$ $\varphi_z = 0$
<b>Rigid</b>		
2D calculation	3D calculation	Boundary conditions
	 <p>Boundary conditions of nodes on all center lines of all layers</p>	$u_x = u_y = u_z = 0$ $\varphi_x = \varphi_y = \varphi_z = 0$

Table 3.5: Predefined types of nodal supports

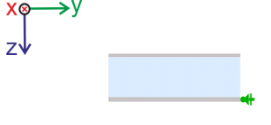

User-defined supports can be entered in the lower table (see Figure 3.18) – for glass layers which contain nodes of this table. First, you specify the *Support Location* and, if necessary, a *Support Rotation*. Then, you can define the degrees of freedom in detail.

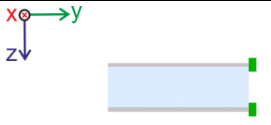
Window 1.4 provides the same buttons as Window 1.3 (see Table 3.4, page 30).

### 3.5 Boundary Members

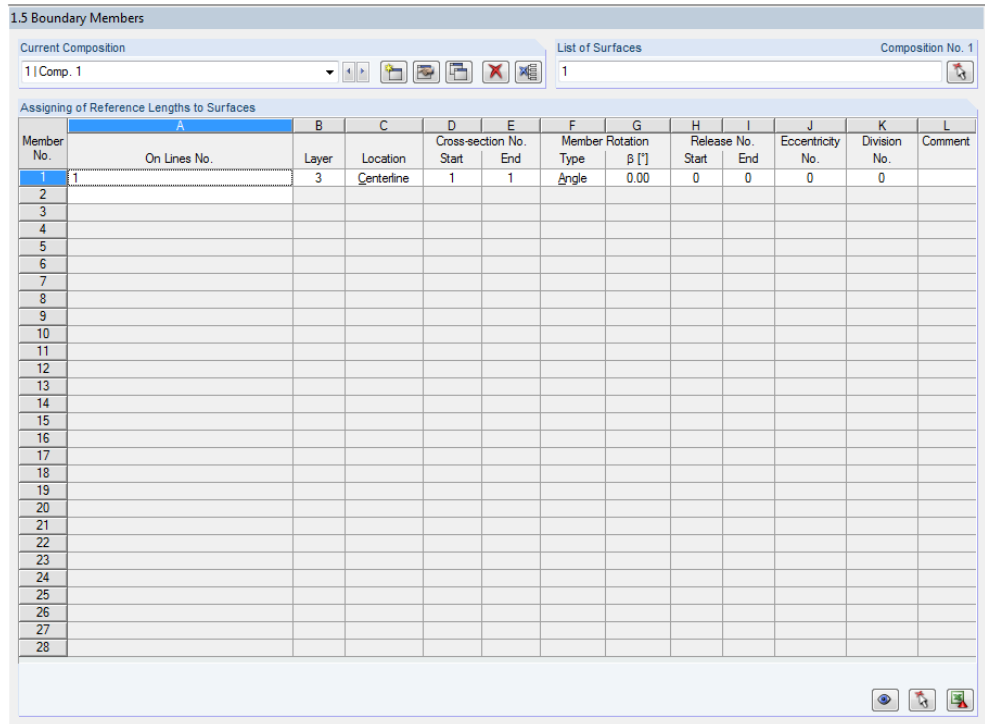

Figure 3.19: Window 1.5 *Boundary Members*

In this window, you can define members at the boundary of the glass surface.

In column A *On Lines No.*, you select the line on which the member lies. In column B, you can specify the *Layer* on whose center line the member is located. Only layers of the type "Glass" are available for selection. In column C, you specify the *Location* of the boundary members at the glass layer (*Upper/Lower edge, Centerline*).

In columns D and E, you select the member's *Cross-section No.* at the start and end of the line. The cross-section must be defined in RFEM beforehand. In columns F and G, you can enter a possible *Member Rotation*. Columns G and H are used for the definition of *Releases* at member ends. In column J, you can define an *Eccentricity*, and in column K a *Division*.

In column L, you can write your own *Comment*.

Window 1.5 provides the same buttons as Window 1.3 (see Table 3.4, page 30).

## 3.6 Climatic Load Parameters

This window appears only if at least one gas layer is selected in Window 1.2, that is, if you specified an insulating glass (see Chapter 3.2 *Layers*).

Single layer and laminated glass without gas layers can be loaded only by load cases defined in RFEM (defined in Window 1.1). Insulated glass, on the other hand, can also be loaded by climatic loads. These are defined in Window 1.6.

1.6 Climatic Load Parameters for Insulating Glass

Current Composition: 2 | Comp. 2 | List of Surfaces: 2 | Composition No. 2

**Climatic Load Parameters - Summer**

Use

Temperature:	Manufacturing: 19.0 [°C]	Temperature External:	Mount: 28.0 [°C]	Difference:	9.0 [°C]
		Gas:	39.0 [°C]		20.0 [°C]
		Internal:	28.0 [°C]		9.0 [°C]
Atmospheric pressure:	Manufacturing: 0.103 [N/mm <sup>2</sup> ]	Atmospheric pressure:	0.101 [N/mm <sup>2</sup> ]		-0.002 [N/mm <sup>2</sup> ]
Altitude:	0.0 [m]	Altitude:	0.0 [m]		0.0 [m]

**Climatic Load Parameters - Winter**

Use

Temperature:	Manufacturing: 27.0 [°C]	Temperature External:	Mount: -10.0 [°C]	Difference:	-37.0 [°C]
		Gas:	2.0 [°C]		-25.0 [°C]
		Internal:	19.0 [°C]		-8.0 [°C]
Atmospheric pressure:	Manufacturing: 0.099 [N/mm <sup>2</sup> ]	Atmospheric pressure:	0.103 [N/mm <sup>2</sup> ]		0.004 [N/mm <sup>2</sup> ]
Altitude:	0.0 [m]	Altitude:	0.0 [m]		0.0 [m]

**Force Load Distribution**

No.	Description	Load Part [%] on Glass Side	External	Internal
LC1	Self-Weight	100.0	0.0	0.0
LC2		100.0	0.0	0.0

**Options**

Calculation according to DIN 18008-2:2010-12, Appendix A  
 help model for rectangular surfaces supported by line support Hinged - type 7

Figure 3.20: Window 1.6 *Climatic Load Parameters for Insulating Glass*

*Climatic Load Parameters* are divided into summer and winter loads. The layout of both parameter sets is the same. Therefore, individual climatic load parameters are explained on the example of **Climatic Load Parameters - Summer** (see also the following figure).

First, you have to select the *Use* check box for the relevant set of parameters.

On the left side, you specify the load parameters *Temperature*, *Atmospheric pressure*, and *Altitude* at the time of the glass *Manufacturing*. On the right, you enter the parameters that are valid after the glass *mount*, that is, when the glass pane is used.

The *Temperature*, which is the same for all insulating glass components during manufacturing, can differ for these components after the mount. External temperature, internal temperature, and gas temperature are to be defined differently for the designs.

The *Difference* between the conditions during manufacturing and after the mount is then displayed on the right.

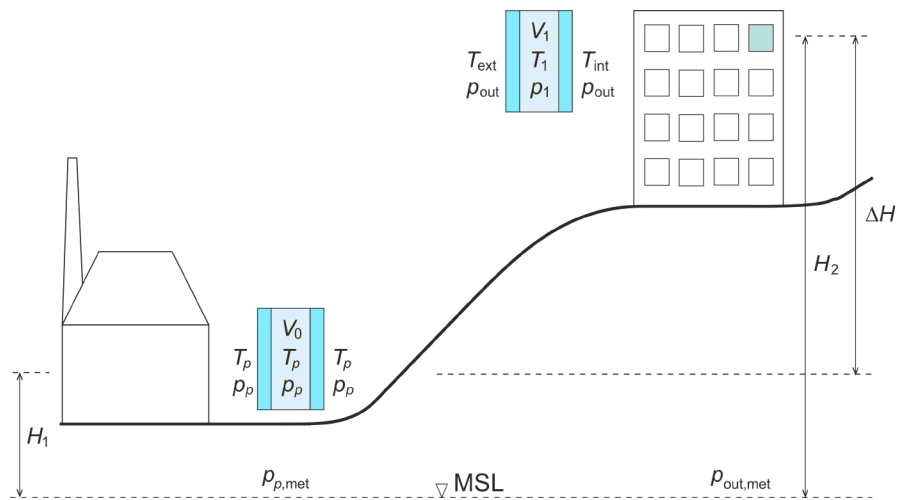

Figure 3.21: Climatic load parameters for manufacturing (left), mount (right), MSL = mean sea level

In the *Load Distribution* section, you can specify how the loads defined in RFEM are distributed to the external and internal glass side. The actions selected for the design are already preset. The 1.2 *Layers* window specifies the position of the sides:

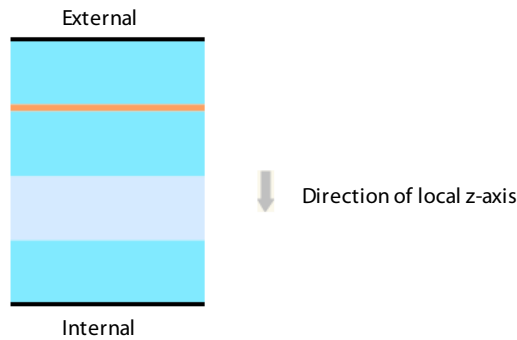

Figure 3.22: External and internal side of insulating glass

For special models, you can use a simplified calculation according to DIN 18008-2:2010-12, Annex A or according to the German technical rules TRLV, Annex A, by selecting the relevant check box in the *Settings* section. For this, the following conditions must be satisfied:

- Rectangular surface without openings
- Exactly one gas layer
- Line support of the type *Hinged – type 7* on all boundary lines
- Loading only by surface load

Kirchhoff's plate theory and the linear static analysis are always applied for the calculation according to TRLV, Annex A (see [1], [2], [5]).

On the bottom right, there are three buttons with the following functions:



Button	Name	Function
	Default	Sets climatic load parameters according to the saved default settings
	Set as Default	Saves current climatic load parameters as new default
	Load Default Dlubal Values	Sets the original presetting according to DIN 18008-2:2010-12, Table 3

Table 3.6: Buttons in window 1.6 *Climatic Load Parameters*

### 3.7 Load Duration

1.7 Load Duration

Assignment of Reference Lengths to Surfaces

Load- ing	A	B	C	D	E	F
	Description	LC Type	Load Duration Class - LDC	Manual	Coefficient $k_{mod}$	Comment
LC1	Self-Weigh	Permanent	Permanent	<input type="checkbox"/>	0.25	
LC2		Snow / ice	Medium-term	<input type="checkbox"/>	0.40	

Figure 3.23: Window 1.7 Load Duration

If you design according to the standard *DIN 18008:2010-12* and select a load case in the *Ultimate Limit State* tab of Window 1.1, the 1.7 *Load Duration* window is displayed.

This window lists all load cases, load combinations, and result combinations that were selected for the design. Columns A and B show the *Description* and *LC Type* defined in RFEM.

In column C, you can specify the *Load Duration Class - LDC*. These classes follow the standard *DIN 18008-2:2010-12*, Table 6. The classification of load combinations automatically follows the governing load. If you select an entry in column C, the corresponding coefficient  $k_{mod}$  is automatically set in column E.

Standard

You can check the values of the coefficients  $k_{mod}$  the *Standard* dialog box. To open it, click *Standard*.



In the bottom right corner, you find the [Export] button that allows you to export the table contents to MS Excel or OpenOffice.org Calc.

### 3.8 Serviceability Data

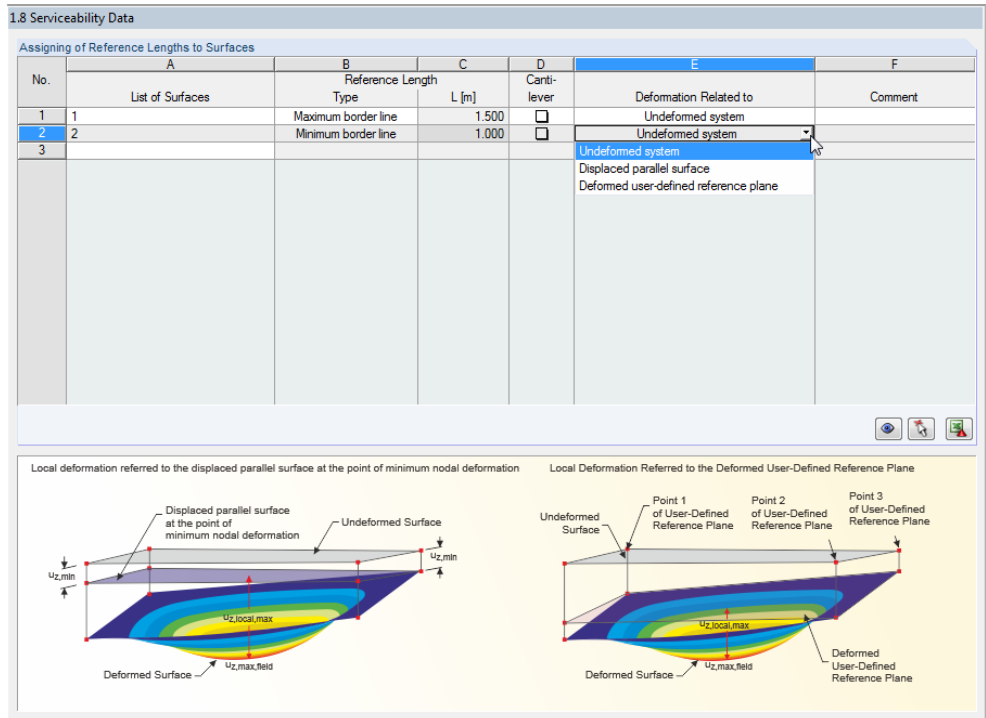

Figure 3.24: Window 1.8 *Serviceability Data*

The 1.8 *Serviceability Data* window is the last input window.

In column A, you specify the surfaces whose deformations you want to analyze.

In column B, you choose the type of the *Reference Length L*. If you select the *Maximum border line*, the length of the longest boundary line of the selected surface is set automatically.

In column D, you can specify whether there is a cantilever or not.

In column E, you specify the system to which deformation is related. If the calculation type *Local – Individual glass surfaces* is selected, only the option *Undeformed system* is available.

In column F, you can write your own *Comment*.

Standard

The specifications of this window are important for the correct application of the limit deformations. You can check and, if necessary, adjust these limit values for the serviceability limit state design in the *Standard* dialog box (see Chapter 4.3).

## 4. Calculation

Calculation

Details...

Before you start the [Calculation], it is necessary to check the detail settings for the design. To open the relevant dialog box, which is described in Chapter 4.1, click [Details].

### 4.1 Details

The *Details* dialog box is divided in the following tabs:

- Stresses
- Results

The following buttons are available in all tabs:





Button	Name	Function
	Units and Decimal Places	Opens the dialog box <i>Units and Decimal Places</i> → Chapter 7.1, page 68
	Dlubal Standard Values	Sets the original Dlubal settings in the <i>Details</i> dialog box
	Default	Sets all parameters in the <i>Details</i> dialog box according to the previously saved default settings
	Set as Default	Saves the current settings as user-defined standard

Table 4.1: Buttons in the *Details*

### 4.1.1 Stresses

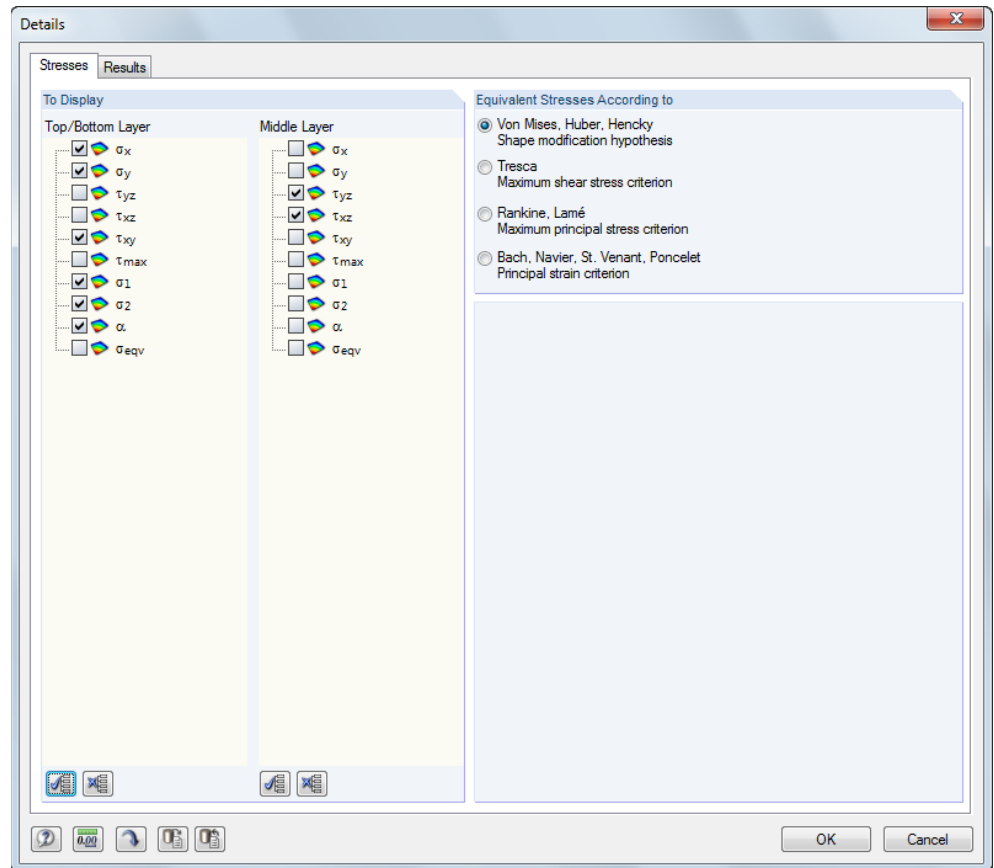

Figure 4.1: Dialog box *Details*, tab *Stresses*

#### To Display

In this section, you choose which stresses you want to display in the result tables by selecting the appropriate check boxes. The stresses are divided in the categories *Top/Bottom Layer* and *Middle Layer*. The buttons [Select All] and [Deselect All] facilitate the selection.

The basic stresses  $\sigma_x, \sigma_y, \tau_{xy}, \tau_{xz}, \tau_{yz}$  are calculated by the finite element method in RFEM. Further stresses are calculated from these basic stresses in the RF-GLASS module. Table 4.2 presents the formulas valid for a single layer plate.

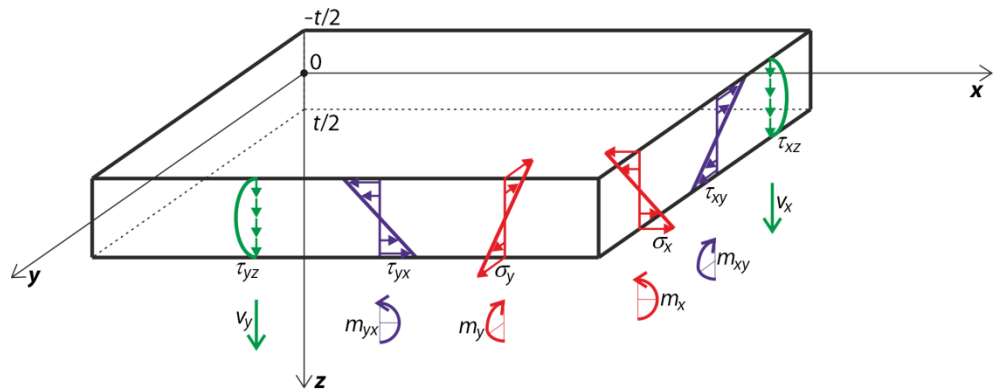

Figure 4.2: Basic stresses and sign convention for single layer plate subjected to bending





$\sigma_x$	<p>Normal stress in <math>x</math>-axis direction</p> <ul style="list-style-type: none"> <li>on positive surface side</li> </ul> $\sigma_{x,+} = \frac{n_x}{t} + \frac{6m_x}{t^2},$ <p>where <math>t</math> = plate thickness</p> <ul style="list-style-type: none"> <li>on negative surface side</li> </ul> $\sigma_{x,-} = \frac{n_x}{t} - \frac{6m_x}{t^2}$	
$\sigma_y$	<p>Normal stress in <math>y</math>-axis direction</p> <ul style="list-style-type: none"> <li>on positive surface side</li> </ul> $\sigma_{y,+} = \frac{n_y}{t} + \frac{6m_y}{t^2}$ <ul style="list-style-type: none"> <li>on negative surface side</li> </ul> $\sigma_{y,-} = \frac{n_y}{t} - \frac{6m_y}{t^2}$	
$\tau_{xy}$	<p>Shear stress in <math>xy</math> plane</p> <ul style="list-style-type: none"> <li>on positive surface side</li> </ul> $\tau_{xy,+} = \frac{n_{xy}}{t} + \frac{6m_{xy}}{t^2}$ <ul style="list-style-type: none"> <li>on negative surface side</li> </ul> $\tau_{xy,-} = \frac{n_{xy}}{t} - \frac{6m_{xy}}{t^2}$	
$\tau_{xz}$	<p>Shear stress in <math>xz</math> plane</p> <ul style="list-style-type: none"> <li>in the plate center</li> </ul> $\tau_{xz} = \frac{3v_x}{2t}$	
$\tau_{yz}$	<p>Shear stress in <math>yz</math> plane</p> <ul style="list-style-type: none"> <li>in the plate center</li> </ul> $\tau_{yz} = \frac{3v_y}{2t}$	

Table 4.2: Basic stresses

Generally, the stresses in individual layers are calculated from the total internal strains of the plate:

$$\boldsymbol{\varepsilon}_{tot}^T = \left\{ \frac{\partial \varphi_y}{\partial x}, -\frac{\partial \varphi_x}{\partial y}, \frac{\partial \varphi_y}{\partial y} - \frac{\partial \varphi_x}{\partial x}, \frac{\partial w}{\partial x} + \varphi_y, \frac{\partial w}{\partial y} - \varphi_x, \frac{\partial u}{\partial x}, \frac{\partial v}{\partial y}, \frac{\partial u}{\partial y} + \frac{\partial v}{\partial x} \right\} \quad (4.1)$$

The strains in individual layers are calculated according to the following relation:

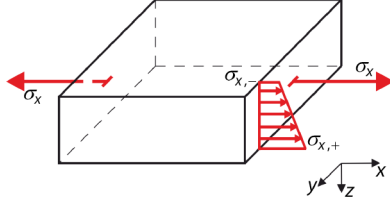
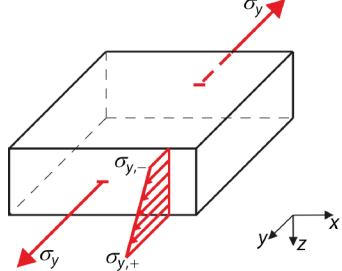
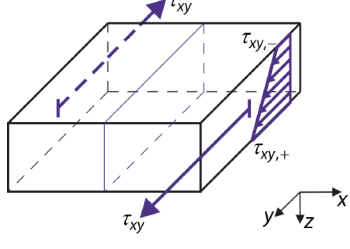
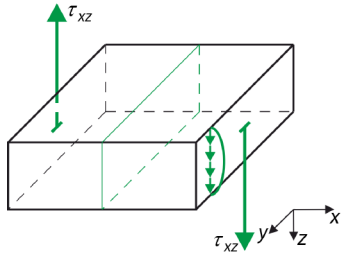
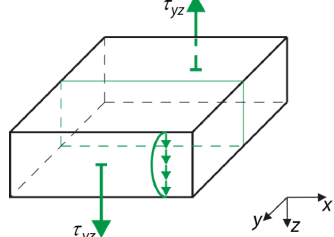
$$\boldsymbol{\varepsilon}(z) = \begin{Bmatrix} \varepsilon_x \\ \varepsilon_y \\ \gamma_{xy} \end{Bmatrix} = \begin{Bmatrix} \frac{\partial u}{\partial x} \\ \frac{\partial v}{\partial y} \\ \frac{\partial u}{\partial y} + \frac{\partial v}{\partial x} \end{Bmatrix} + z \begin{Bmatrix} \frac{\partial \varphi_y}{\partial x} \\ -\frac{\partial \varphi_x}{\partial y} \\ \frac{\partial \varphi_y}{\partial y} - \frac{\partial \varphi_x}{\partial x} \end{Bmatrix}, \quad (4.2)$$

where  $z$  : is the coordinate in  $z$ -axis direction, where the stress value is requested.

If there is, for example,  $i$ -layer, the stress is calculated according to the following relation:

$$\boldsymbol{\sigma}(z) = \mathbf{d}_i \boldsymbol{\varepsilon}(z) \quad (4.3)$$

where  $\mathbf{d}_i$  : is the partial stiffness matrix of the  $i$ -th layer.

The effect of the transversal shear stresses is expressed by the quantity:

$\tau_{max}$	Maximum transversal shear stress $\tau_{max} = \sqrt{\tau_{yz}^2 + \tau_{xz}^2}$
--------------	---

Table 4.3: Maximum transversal shear stress

Table 4.4 shows the formula for the calculation of the maximum and equivalent stresses.

$\sigma_1$	Principal stress $\sigma_1 = \frac{\sigma_x + \sigma_y + \sqrt{(\sigma_x - \sigma_y)^2 + 4\tau_{xy}^2}}{2}$
$\sigma_2$	Principal stress $\sigma_2 = \frac{\sigma_x + \sigma_y - \sqrt{(\sigma_x - \sigma_y)^2 + 4\tau_{xy}^2}}{2}$
$\alpha$	<p>Angle between the local <math>x</math>-axis and the direction of the first principal stress</p> $\alpha = \frac{1}{2} \operatorname{atan2}(2\tau_{xy}, \sigma_x - \sigma_y), \alpha \in (-90^\circ, 90^\circ]$ <p>Function atan2 is implemented in RFEM as follows:</p> $\operatorname{atan2}(y, x) = \begin{cases} \arctan \frac{y}{x} & x > 0 \\ \arctan \frac{y}{x} + \pi & y \geq 0, x < 0 \\ \arctan \frac{y}{x} - \pi & y < 0, x < 0 \\ +\frac{\pi}{2} & y > 0, x = 0 \\ -\frac{\pi}{2} & y < 0, x = 0 \\ 0 & y = 0, x = 0 \end{cases}$ 
$\sigma_{\text{eqv}}$	Equivalent stress according to VON MISES, HUBER, HENCKY (Shape modification hypothesis) $\sigma_{\text{eqv}} = \sqrt{\sigma_x^2 + \sigma_y^2 - \sigma_x \sigma_y + 3\tau_{xy}^2}$
	Equivalent stress according to TRESCA (Maximum shear stress criterion) $\sigma_{\text{eqv}} = \max \left[ \sqrt{(\sigma_x - \sigma_y)^2 + 4\tau_{xy}^2}, \frac{ \sigma_x + \sigma_y  + \sqrt{(\sigma_x - \sigma_y)^2 + 4\tau_{xy}^2}}{2} \right]$
	Equivalent stress according to RANKINE, LAMÉ (Maximum principal stress criterion) $\sigma_{\text{eqv}} = \frac{ \sigma_x + \sigma_y  + \sqrt{(\sigma_x - \sigma_y)^2 + 4\tau_{xy}^2}}{2}$
	Equivalent stress according to BACH, NAVIER, ST. VENANT, PONCELET (Principal strain criterion) $\sigma_{\text{eqv}} = \max \left[ \frac{1-\nu}{2}  \sigma_x + \sigma_y  + \frac{1+\nu}{2} \sqrt{(\sigma_x - \sigma_y)^2 + 4\tau_{xy}^2}, \nu  \sigma_x + \sigma_y  \right]$

Table 4.4: Stresses

### Equivalent stresses

You can determine the equivalent stresses in four different ways.

#### Von Mises, Huber, Hencky (shape modification hypothesis)

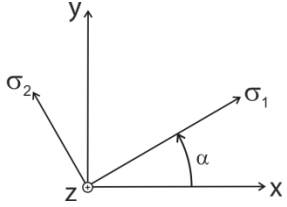
The shape modification hypothesis is also known as HMM (HUBER, VON MISES, HENCKY). The equivalent stresses are calculated as follows:

$$\sigma_{\text{eqv}} = \sqrt{\sigma_x^2 + \sigma_y^2 - \sigma_x \sigma_y + 3\tau_{xy}^2} \quad (4.4)$$

#### Tresca (maximum shear stress criterion)

This equivalent stress is generally defined by using the relation:

$$\sigma_{\text{eqv}} = \max(|\sigma_1 - \sigma_2|, |\sigma_1 - \sigma_3|, |\sigma_2 - \sigma_3|) \quad (4.5)$$

which on the condition  $\sigma_3 = 0$  can be simplified to:

$$\sigma_{\text{eqv}} = \max(|\sigma_1 - \sigma_2|, |\sigma_1|, |\sigma_2|) \quad (4.6)$$

This results in the following equation:

$$\sigma_{\text{eqv}} = \max \left[ \sqrt{(\sigma_x - \sigma_y)^2 + 4\tau_{xy}^2}, \frac{|\sigma_x + \sigma_y| + \sqrt{(\sigma_x - \sigma_y)^2 + 4\tau_{xy}^2}}{2} \right] \quad (4.7)$$

#### Rankine, Lamé (maximum principal stress criterion)

This hypothesis is known as the normal stress hypothesis or as the equivalent stress according to RANKINE. The Rankine's stress is generally defined as the maximum of absolute values of principal stresses.

$$\sigma_{\text{eqv}} = \max(|\sigma_1|, |\sigma_2|, |\sigma_3|) \quad (4.8)$$

which on the condition  $\sigma_3 = 0$  can be simplified to:

$$\sigma_{\text{eqv}} = \max(|\sigma_1|, |\sigma_2|) \quad (4.9)$$

This results in the following equation:

$$\sigma_{\text{eqv}} = \frac{|\sigma_x + \sigma_y| + \sqrt{(\sigma_x - \sigma_y)^2 + 4\tau_{xy}^2}}{2} \quad (4.10)$$

#### Bach, Navier, St. Venant, Poncelet (principal strain criterion)

The principal deformation hypothesis is also known as the equivalent stress according to Bach. It is assumed that the failure occurs in the direction of the greatest strain. The equivalent stress is determined as follows:

$$\sigma_{\text{eqv}} = \max(|\sigma_1 - \nu(\sigma_2 + \sigma_3)|, |\sigma_2 - \nu(\sigma_1 + \sigma_3)|, |\sigma_3 - \nu(\sigma_1 + \sigma_2)|) \quad (4.11)$$

For  $\sigma_3 = 0$ , we can simplify:

$$\sigma_{\text{eqv}} = \max(|\sigma_1 - \nu\sigma_2|, |\sigma_2 - \nu\sigma_1|, \nu|\sigma_1 + \sigma_2|) \quad (4.12)$$

This results in the following equation:

$$\sigma_{\text{eqv}} = \max \left[ \frac{1-\nu}{2} |\sigma_x + \sigma_y| + \frac{1+\nu}{2} \sqrt{(\sigma_x - \sigma_y)^2 + 4\tau_{xy}^2}, \nu |\sigma_x + \sigma_y| \right] \quad (4.13)$$

In the formulas for the equivalent stresses, the influence of shear stresses  $\tau_{xz}$  and  $\tau_{yz}$  is neglected.

### 4.1.2 Results

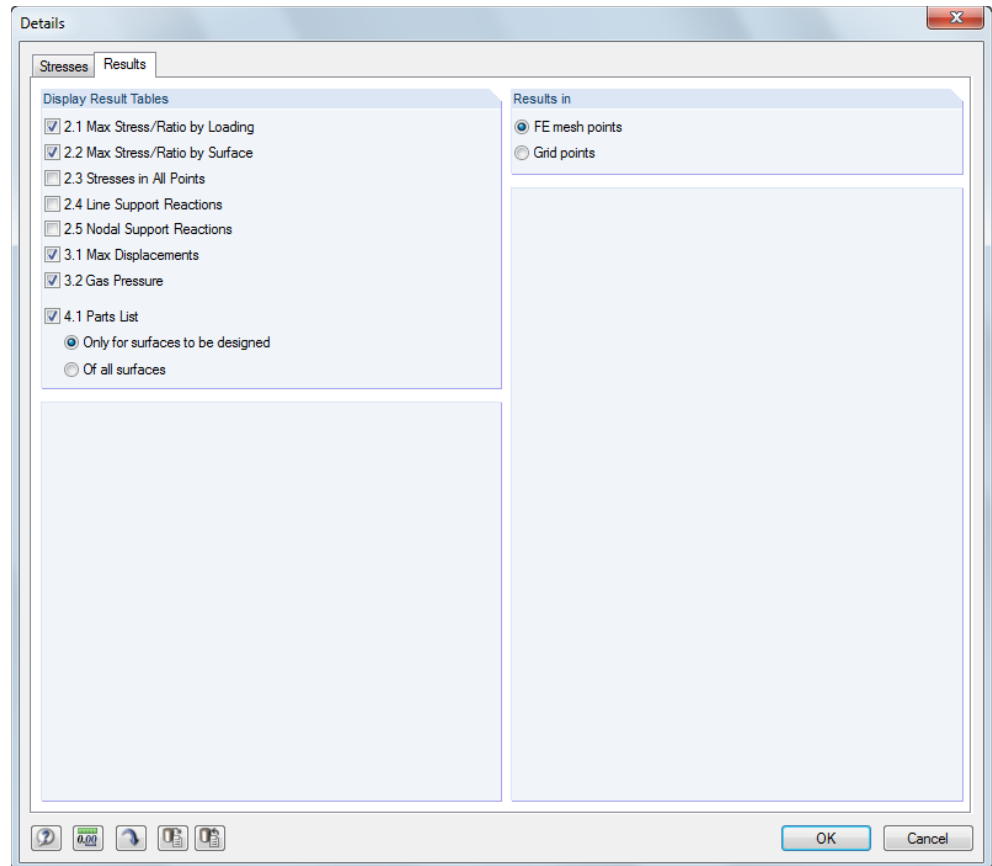

Figure 4.3: Dialog box *Details*, tab *Results*

#### Display Result Tables

In this section, you can specify which result tables you want to display (stresses, reactions, displacements, gas pressure, parts lists).

The result windows are described in Chapter 5 *Results*, page 55.

#### Results in

Stresses and displacements are displayed in all FE mesh points by default. The results can also be shown in the grid points (see RFEM manual, Chapter 8.12). The grid points can be defined in RFEM as property of a surface.

For small surfaces, the default grid point spacing of 0.5 m can result in only a small number of grid points (or even just one result grid point in the origin). In this case, the spacing of grid points should be adapted to the surface dimensions in RFEM in order to create more grid points.

## 4.2 Details of Composition

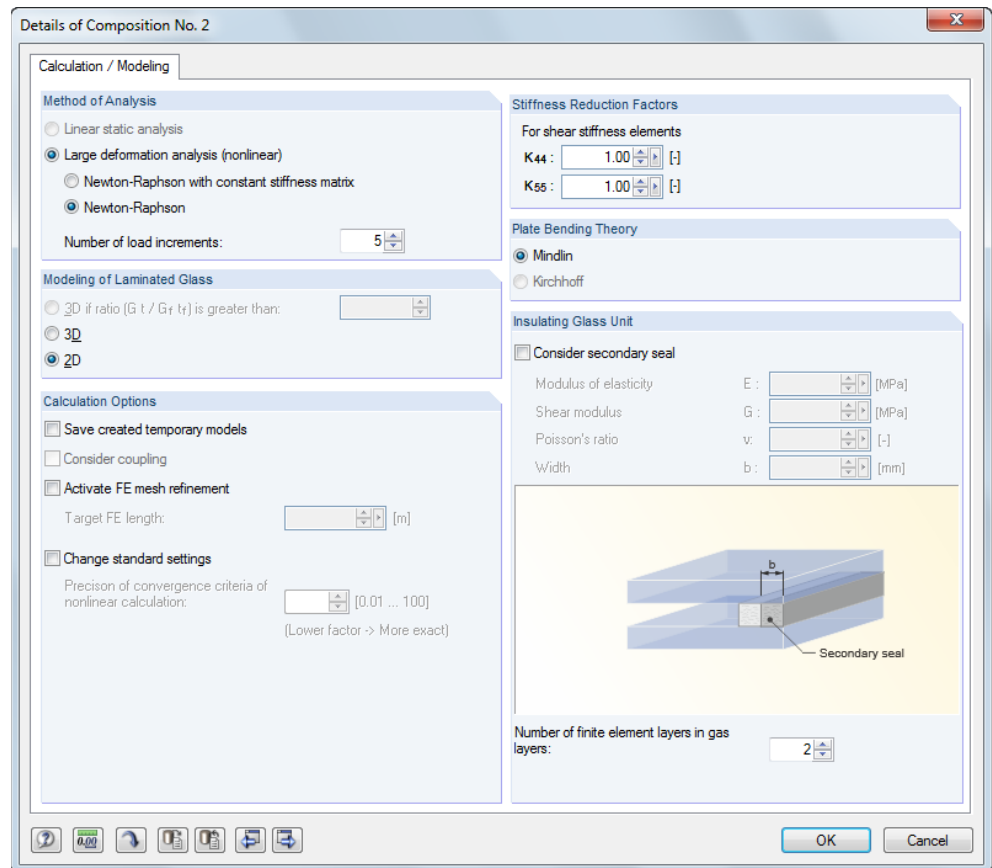

Figure 4.4: Dialog box *Details, Calculation / Modeling* for *Local* calculation type



To open the *Details of Composition* dialog box, click the [Edit Composition Details] button available in the upper part of Windows 1.2 through 1.6.

### Method of Analysis

This section controls whether a calculation is carried out according to the *Linear static analysis* or the *Large deformation analysis (nonlinear)*. The linear static analysis is preset.

However, if you create an insulating glass (with an intermediate gas layer), the program automatically switches to the large deformation analysis: The intermediate gas layer introduces a non-linearity to this model, which causes differences between the linear static and large deformation analysis even for small load values. Here, calculation according to the large deformation analysis gives more precise results. The iterative calculation of the solid elements is done according to the methods *Newton-Raphson with constant stiffness matrix* or *Newton-Raphson*. The differences between these methods are described in the RFEM manual, Chapter 7.3.1.1.

### Modeling of Laminated Glass

As described in Chapter 2.2.1, the standard theory may give incorrect results. If the ratio  $G \cdot t / G_f \cdot t_f$  is greater than the defined limit value, the calculation proceeds in 3D. In this term,  $G$  is the shear modulus of glass,  $t$  is the thickness of the glass layer,  $G_f$  is the shear modulus of the foil, and  $t_f$  is the foil thickness.

You can also set the type of calculation manually to 2D or 3D. Of course, 3D calculations are more accurate, but also more time-consuming.

If you create an insulating glass (with an intermediate gas layer), the 3D calculation is set automatically.

### Calculation Options

In this section, you can specify general settings for the RF-GLASS calculation. The first check box of this section allows you to *Save created temporary models*: As already mentioned in Chapter 3.1 *General Data* on page 17, for the *Local* calculation type the supports and boundary members are entered directly in RF-GLASS without influencing the rest of the RFEM model. If the check box is selected, these models are saved as new RFEM files when you save the entered data in RF-GLASS. They can be found in the same project folder as the original file and are marked by the addition *RF\_GLASS* in the file name. After opening such a file, you can graphically check the RF-GLASS models in RFEM with all supports, members, solids, etc.

The *Consider coupling* check box is automatically selected in the case of laminated glass with foils so that the shear resistance of the laminating foil is considered. Shear coupling of layers was already mentioned in Chapter 2.2.1 *Laminated Glass* on page 9.

If you *Activate FE mesh refinement*, you can manually define the *Target FE length*.

If you select the *Change standard settings* check box, you can influence the precision of the convergence criteria for the nonlinear calculation. The value 1.0 is set as default here. The minimum allowable value is 0.01, the maximum value is 100.

### Stiffness Reduction Factors

In the section *Stiffness Reduction Factors*, you can reduce shear stiffness matrix elements  $D_{44}$  and  $D_{55}$  by using reduction factors  $K_{44}$  and  $K_{55}$ . The correction is possible only for 2D calculation.

The stiffness matrix is then equal to (the case of the symmetric composition is shown here):

$$\begin{Bmatrix} m_x \\ m_y \\ m_{xy} \\ v_x \\ v_y \\ n_x \\ n_y \\ n_{xy} \end{Bmatrix} = \begin{bmatrix} D_{11} & D_{12} & 0 & 0 & 0 & 0 & 0 & 0 \\ & D_{22} & 0 & 0 & 0 & 0 & 0 & 0 \\ & & D_{33} & 0 & 0 & 0 & 0 & 0 \\ & & & K_{44}D_{44} & 0 & 0 & 0 & 0 \\ & & & & K_{55}D_{55} & 0 & 0 & 0 \\ & & \text{sym.} & & & D_{66} & D_{67} & 0 \\ & & & & & & D_{77} & 0 \\ & & & & & & & D_{88} \end{bmatrix} \begin{Bmatrix} \kappa_x \\ \kappa_y \\ \kappa_{xy} \\ \gamma_{xz} \\ \gamma_{yz} \\ \varepsilon_x \\ \varepsilon_y \\ \gamma_{xy} \end{Bmatrix} \quad (4.14)$$

In Window 1.2 *Layers*, you can display the modified stiffness matrix by clicking the [Show extended stiffness matrix elements] button.

### Plate Bending Theory

For surfaces, you can choose the bending theory according to:

- Mindlin or
- Kirchhoff

The shear strain is considered for the calculation according to the Mindlin theory, but not according to the Kirchhoff theory. The bending theory according to Mindlin is suitable for massive plates, the bending theory according to Kirchhoff for relatively thin plates.

Because the shear stresses  $\tau_{xz}$  and  $\tau_{yz}$  are not determined exactly in Kirchhoff's theory, they are calculated from equilibrium conditions. You can calculate them by using the following relations

$$\tau_{xz, \max} = \frac{3}{2} \frac{v_x}{t} = 1.5 \frac{v_x}{t} \quad (4.15)$$

$$\tau_{yz,\max} = \frac{3 v_y}{2 t} = 1.5 \frac{v_y}{t} \quad (4.16)$$

### Insulating Glass Unit

This dialog section is accessible only for insulating glass. After selecting the *Consider secondary seal* check box, you can enter the material properties and the width of a secondary seal.

The following figure illustrates the individual components of insulating glass.

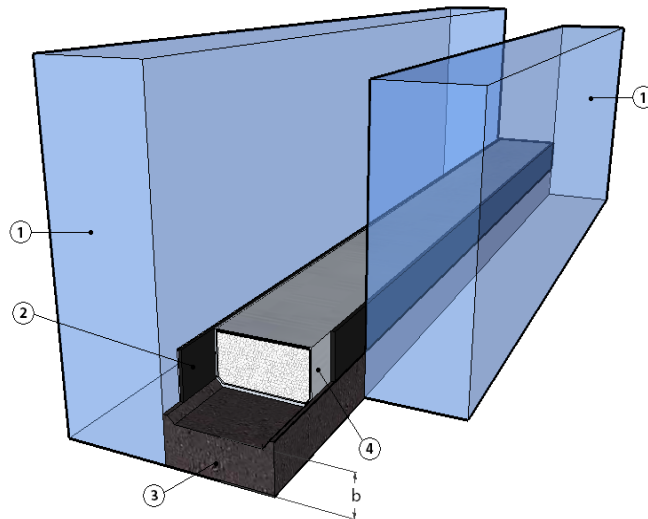

Figure 4.5: Insulating glass with 1) glass pane, 2) primary seal, 3) secondary seal, and 4) spacer

If necessary, you can adjust the *Number of finite element layers in gas layers* for insulating glass.



### 4.3 Standard

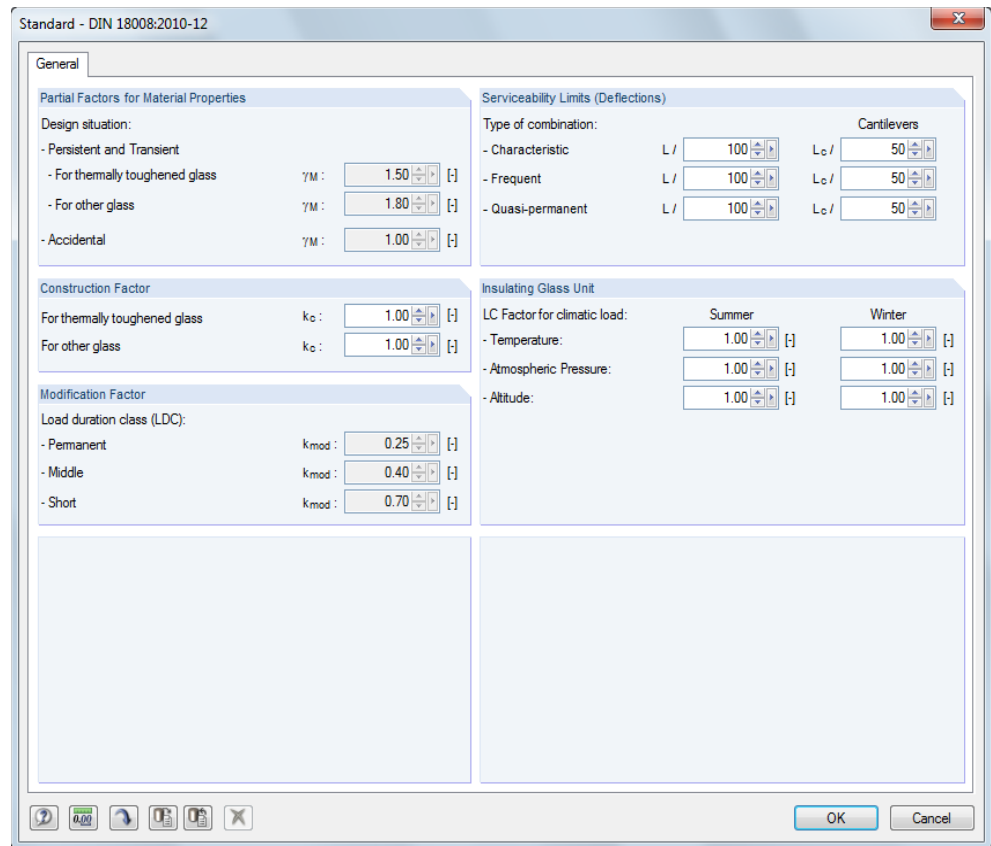
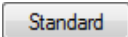

Figure 4.6: Dialog box *Standard*



To open the *Standard* dialog box, click [Standard].

In the upper right corner of Window 1.1 *General Data*, you select the standard from which the parameters will be applied for the design and the limit values of the deflection.

The following standards can be selected:

- DIN 18008:2010-12
- TRLV:2006-08
- None

#### 4.3.1 Standard – DIN 18008:2010-12

For standard *DIN 18008:2010-12* the design value (limit stress) depends on the type of the glass. Therefore in the 1.2 *Layers* window you have to set whether glass is thermally toughened or not.

For thermally toughened glass the design stress value ( $\sigma_{limit,d}$ ) is calculated from the characteristic limit stress value ( $\sigma_{limit,k}$ ), according to the following relation:

$$\sigma_{limit,d} = \frac{k_c \cdot \sigma_{limit,k}}{\gamma_M}$$

where  $k_c$ : is the construction factor

$\sigma_{limit,k}$ : is the characteristic limit stress value set in the 1.2 *Layers* window

$\gamma_M$ : is the partial factor for thermally toughened glass

The design stress value for glass which is not thermally toughened is calculated according to the following relation:

$$\sigma_{\text{limit,d}} = \frac{k_{\text{mod}} \cdot k_c \cdot \sigma_{\text{limit,k}}}{\gamma_M}$$

where  $k_{\text{mod}}$  : is the modification factor

$k_c$  : is the construction factor

$\sigma_{\text{limit,k}}$  : is the characteristic limit stress value set in the 1.2 *Layers* window

$\gamma_M$  : is the partial factor for other glass

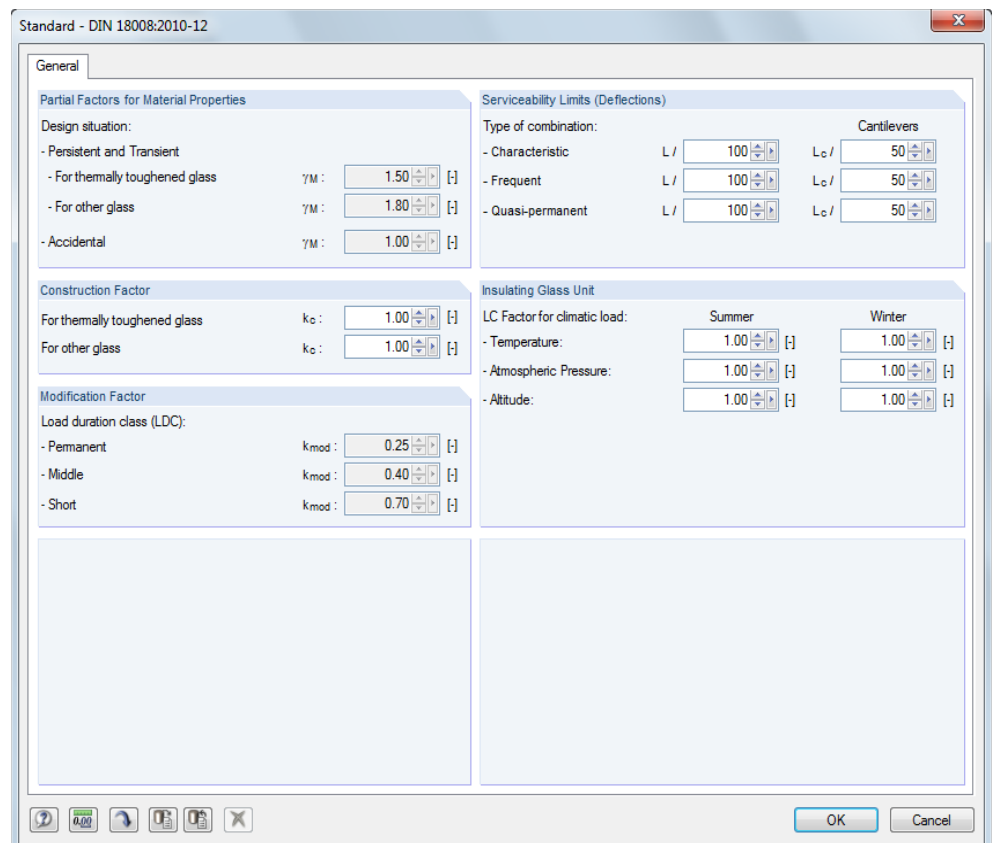

Figure 4.7: Dialog box *Standard – DIN 18008:2010-12*

Individual sections of this dialog are described in the following sections.

### Partial Factors for Material Properties

In this section, you can check the partial factors of the material properties  $\gamma_M$  for the possible design situations. The design situations are to be assigned to individual load cases and combinations in the *Ultimate Limit State* tab of the 1.1 *General Data* window (see Chapter 3.1.1, page 21).

### Construction Factor

In this section, you can define the factor  $k_c$  manually.

### Modification Factor

The values of the modification factor  $k_{\text{mod}}$  are shown in this section for every load duration class. The values follow the standard DIN 18008-2:2010-12, Table 6. The modification factor  $k_{\text{mod}}$  is assigned to the load cases according to the corresponding load duration class in the 1.7 *Load Duration* window, (see Chapter 3.7, page 37).

### Serviceability Limits (Deflections)

The limit values of allowable deflections can be set in the six available text boxes. In this way, you can enter specific data for various action combinations (*Characteristic, Frequent, and Quasi-permanent*) and for surfaces supported on both sides or one side only.

The classification of the load cases is to be done in the *Serviceability Limit State* tab of the 1.1 *General Data* window (see Chapter 3.1.2, page 22). In the 1.8 *ServiceabilityData* window, you enter the reference lengths *L* for individual surfaces (see Chapter 3.8, page 38).

### Insulating Glass Unit

In this section, you can set factors, by which the climatic load is to be multiplied. The climatic load is then considered with this factor for each action that is selected in the 1.1 *General Data* window for design. Climatic loads are set in the 1.6 *Climatic Load Parameters* window.



The buttons in the bottom left corner of the *Standard* dialog box allow you to save modified values as the default setting. Furthermore, you can use the buttons to import saved parameters or to restore the default settings of the program.



A user-defined standard can be deleted by using the [Delete] button.

### 4.3.2 Standard – TRLV:2006-08

For the standard *TRLV:2006-08* the design value (limit stress) is the same value as the characteristic limit stress set in the 1.2 *Layers* window.

$$\sigma_{\text{limit,d}} = \sigma_{\text{limit,k}}$$

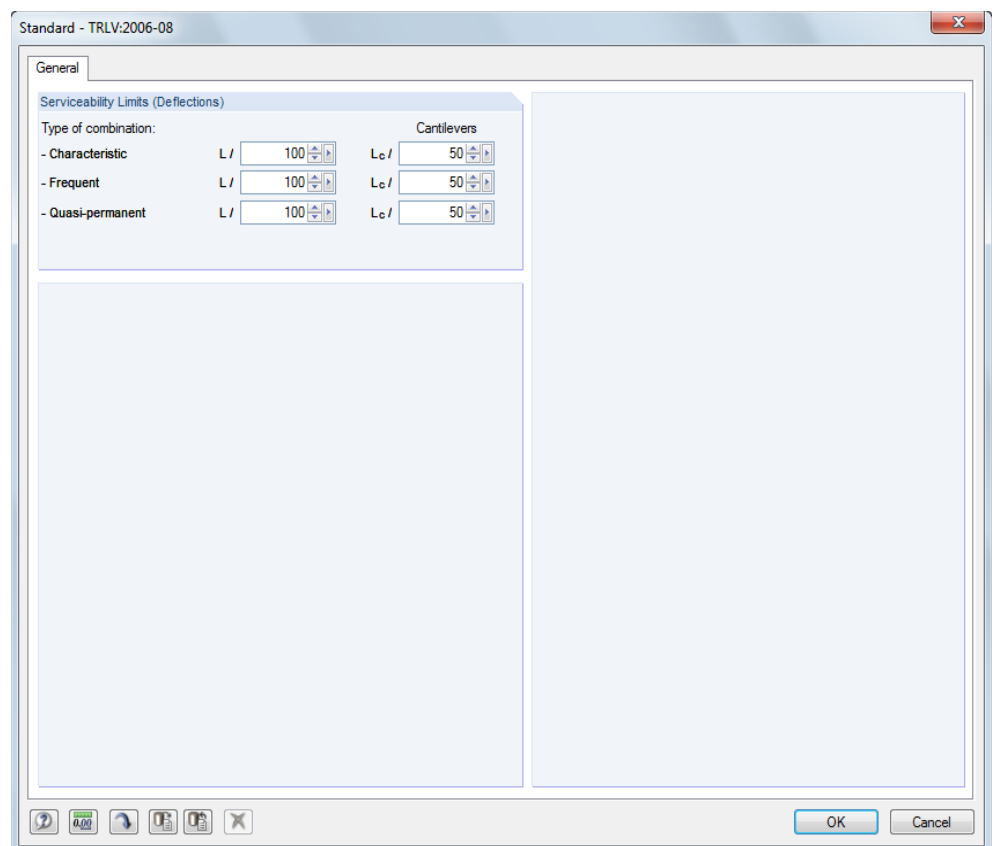

Figure 4.8: Dialog box *Standard – TRLV:2006-08*

### Serviceability Limits (Deflections)

The limit values of allowable deflections can be set in the six available text boxes. In this way, you can enter specific data for various action combinations (*Characteristic, Frequent, and Quasi-permanent*) and for surfaces supported on both sides or one side only.

The classification of the load cases is to be done in the *Serviceability Limit State* tab of the 1.1 *General Data* window (see Chapter 3.1.2, page 22). In the 1.8 *ServiceabilityData* window, you enter the reference lengths *L* for individual surfaces (see Chapter 3.8, page 38).

#### 4.3.3 Standard – None

By selecting *None* for the standard, the design stress value ( $\sigma_{limit,d}$ ) is calculated from the characteristic limit stress value ( $\sigma_{limit,k}$ ), according to the following relation:

$$\sigma_{limit,d} = \frac{\sigma_{limit,k}}{\gamma_M}$$

where  $\sigma_{limit,k}$ : is the characteristic limit stress value set in the 1.2 *Layers* window

$\gamma_M$ : is the partial factor

If the partial factor is not used, then the module assumes  $\gamma_M = 1$ .

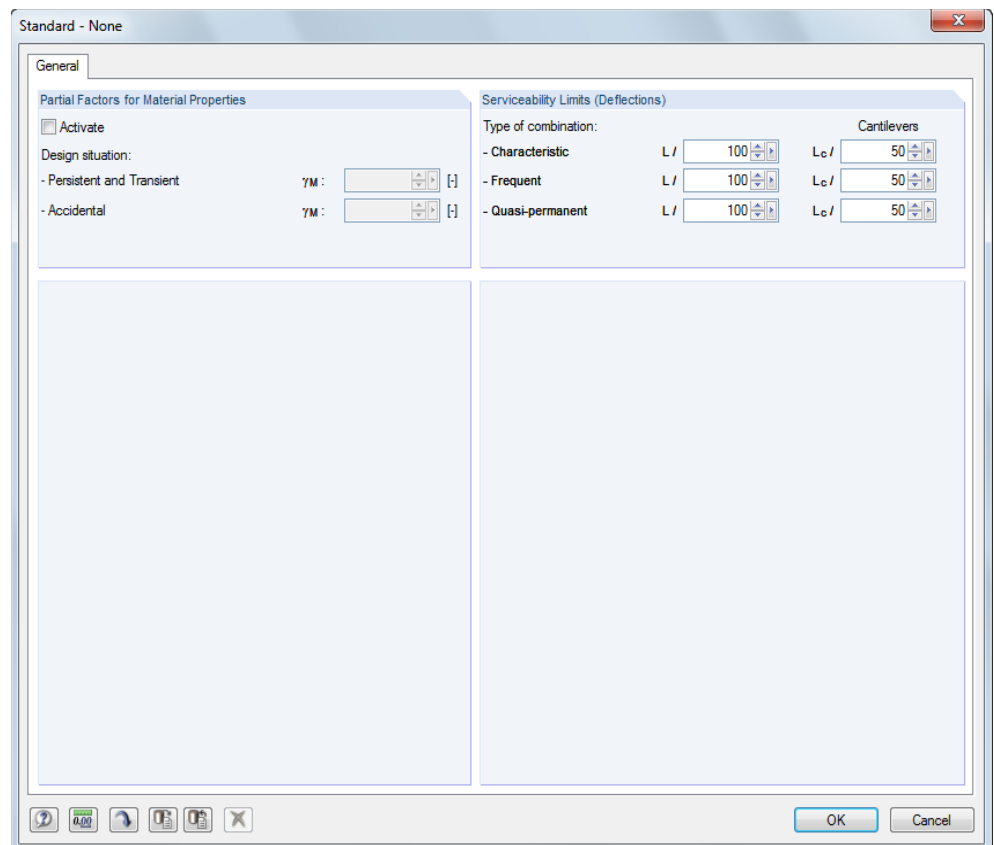

Figure 4.9: Dialog box *Standard – None*

Individual sections of this dialog are described in the following sections.

#### Partial Factors for Material Properties

In this section, you can activate and then rewrite the partial factors of the material properties  $\gamma_M$  for the possible design situations. The design situations are to be assigned to individual load cases and combinations in the *Ultimate Limit State* tab of the 1.1 *General Data* window (see Chapter 3.1.1, page 21).

### Serviceability Limits (Deflections)

The limit values of allowable deflections can be set in the six available text boxes. In this way, you can enter specific data for various action combinations (*Characteristic, Frequent, and Quasi-permanent*) and for surfaces supported on both sides or one side only.

The classification of the load cases is to be done in the *Serviceability Limit State* tab of the 1.1 *General Data* window (see Chapter 3.1.2, page 22). In the 1.8 *ServiceabilityData* window, you enter the reference lengths  $L$  for individual surfaces (see Chapter 3.8, page 38).

## 4.4 Start calculation

Calculation

You can start the [Calculation] in all input windows of the module by using the button with the same name.

You can also start the calculation from the RFEM user interface. The *To Calculate* dialog box (menu *Calculate* → *To Calculate*) lists the design cases of the add-on modules like load cases or load combinations.

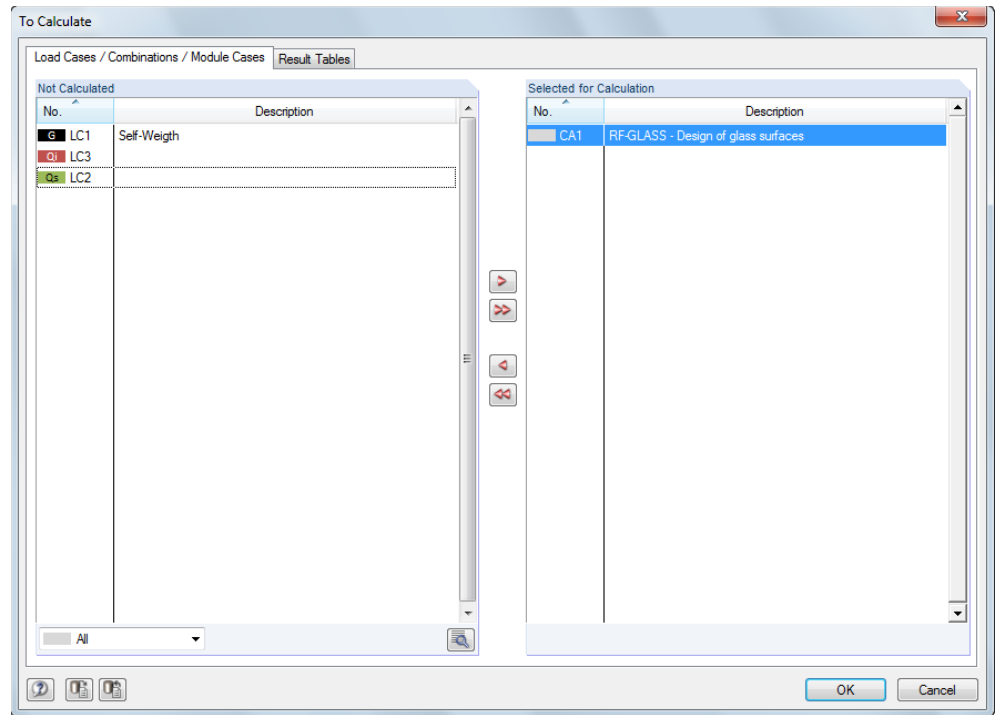

Figure 4.10: Dialog box *To Calculate* in RFEM

If the RF-GLASS design case is missing in the *Not Calculated* list, you have to select *All* or *Add-on Modules* in the drop-down list located in bottom part of the dialog box.



By using the [▶] button, you transfer the selected RF-GLASS case to the list on the right. To start the calculation, click [OK].



You can also start the RF-GLASS calculation directly from the toolbar. To do this, set the RF-GLASS case in the list, and then click [Show Results].



Figure 4.11: Direct calculation of the RF-GLASS case in RFEM

## 5. Results

Immediately after the calculation, the 2.1 *Max Stress/Ratio by Loading* window appears (see Figure 5.1). To select other result windows, you can click the corresponding item in the navigator. To browse through the module windows, you can use the buttons [ $\leftarrow$ ] and [ $\rightarrow$ ], or press the function keys [F2] and [F3].



Details...

OK

In the *Results* tab of the *Details* dialog box, you can specify which result windows you want to display (see Chapter 4.1.2 on page 45).

To save the results, click [OK]. Thus, you exit RF-GLASS and return to the main program.

Below the tables, you find a number of buttons that are useful for the evaluation of the results:







Button	Name	Function
	View mode	Allows you to jump to the RFEM work window to change the view
	Selection	Allows for the graphical selection of a surface or a point to display these results in the table
	Result diagrams	Displays results from the current row in the RFEM background graphic
	Exceeding	Displays only the rows with the design ratio $> 1$ in tables, that is, the design is not satisfied
	Relation scale	Displays or hides the color bars in the results windows
	Excel export	Opens the <i>Export table</i> dialog box → Chapter 7.2, page 69

Table 5.1: Buttons in results windows

Chapter 5 *Results* presents the results windows in their order.

## 5.1 Max Stress/Ratio by Loading

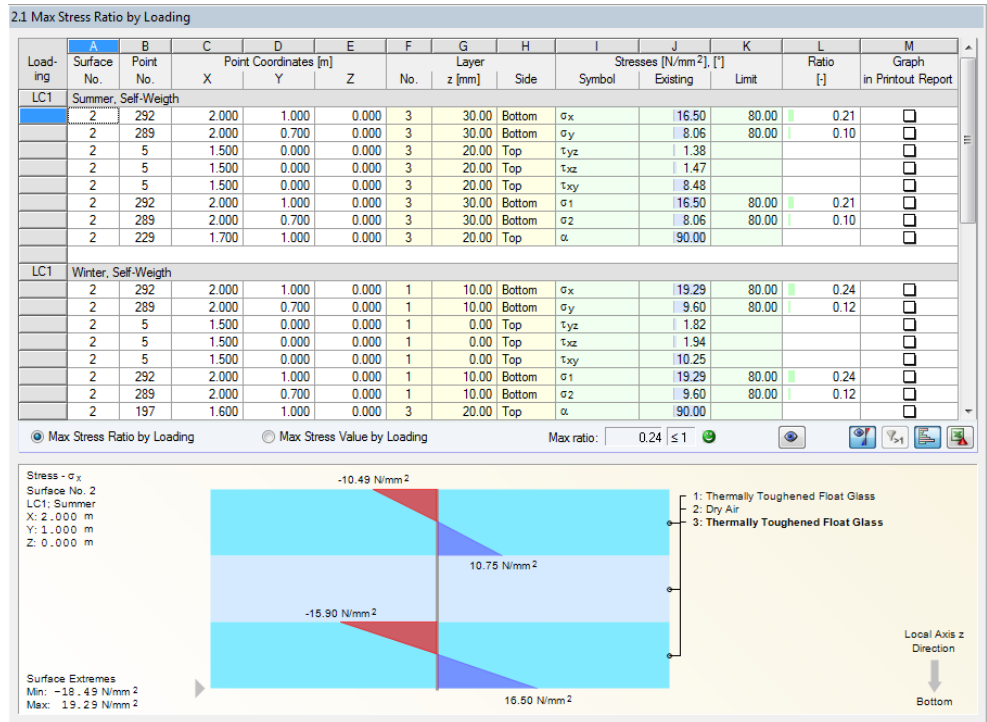

Figure 5.1: Window 2.1 Max Stress/Ratio by Loading

The window lists the maximum stress values or ratios for each load case and each load and result combination selected in the *Ultimate Limit State* tab of the 1.1 *General Data* window. The numbers of load cases are shown in the heading of each section.

### Surface No.

This column shows the numbers of the surfaces with the governing points.

### Point No.

In this FE or grid points, the maximum ratio was determined. The stress type is shown in column I *Symbol*.

The FE mesh points are created automatically. The grid points, on the other hand, can be controlled in RFEM, because user-defined result grids are possible for surfaces. The function is described in Chapter 8.12 of the RFEM manual. In the *Results* tab of the *Details* dialog box, you can specify whether you want to evaluate the results in FE mesh points or grid points (see Chapter 4.1.2, page 45). If you decide to change the settings, the results are deleted.

### Point Coordinates

The three columns show the coordinates of the respective governing FE or grid points.

### Layer

Columns F, G, and H list the numbers,  $z$  –coordinates, and sides of the layers, where maximum stress values occur, respectively.

Details...



Details...

### Stresses

#### Symbol / Existing

These two columns show the stresses selected in the *Stresses* tab of the *Details* dialog box (see Chapter 4.1.1). They show the respective stress type with the maximum value.

#### Limit

The limit values (limit stresses)  $\sigma_{\text{limit,d}}$  are based on the materials specified in the 1.2 *Layers* window and in the selected standard. The calculation of limit value is described in Chapter 4.3, page 49.

#### Ratio

For the tension stress components  $\sigma_x, \sigma_y, \sigma_1$  and  $\sigma_2$ , the ratio of the design is determined with regard to the limit stress. If the limit stress is not exceeded, the ratio is less than or equal to 1, and the stress analysis is satisfied. Thus, the values in column L allow you to quickly evaluate the design economy.

The ratio is calculated only for positive (tension) stress values  $\sigma_x, \sigma_y, \sigma_1$  and  $\sigma_2$ , because the tension stiffness  $\sigma_{\text{limit,d}}$  is governing for glass.

The following table describes the calculation of the ratios.

Max ratio: 0.24 ≤ 1 

Stresses [Pa]	Ratio [-]
$\sigma_x$	$= \frac{\sigma_x}{\sigma_{\text{limit,d}}}$
$\sigma_y$	$= \frac{\sigma_y}{\sigma_{\text{limit,d}}}$
$\sigma_1$	$= \frac{\sigma_1}{\sigma_{\text{limit,d}}}$
$\sigma_2$	$= \frac{\sigma_2}{\sigma_{\text{limit,d}}}$

Table 5.2: Ratio

#### Graph in Printout Report

In the lower part of the window, the stress distribution in the layers is shown graphically for the current point (that is, for the table row, in which the cursor is placed).

By selecting the check boxes in this column, you can include stress graphs in the results chapter of the printout report (see Chapter 6.1, page 65).

## 5.2 Max Stress/Ratio by Surface

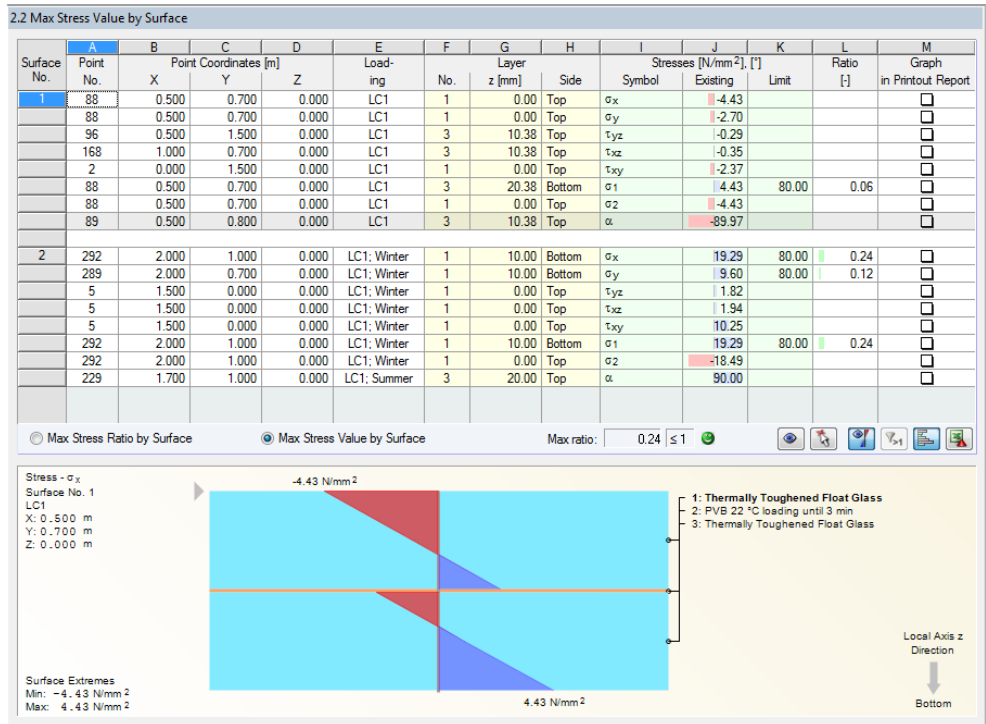

Figure 5.2: Window 2.2 Max Stress/Ratio by Surface

This results window lists the maximum stress values or ratios for every designed surface. The columns of this table are described in Chapter 5.1.

### 5.3 Stresses in All Points

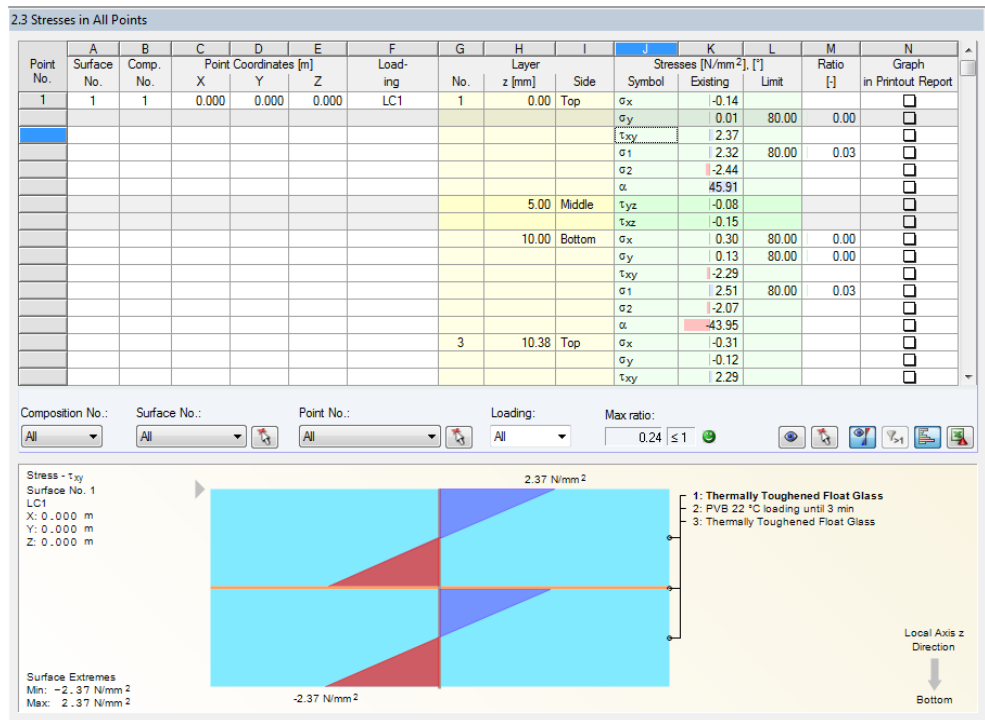

Figure 5.3: Window 2.3 Stresses in All Points

This table shows the stresses and stress ratios for each FE mesh or grid point of the designed surfaces. In the *Results* tab of the *Details* dialog box (see Chapter 4.1.2, page 45) you can set whether you want to display the results in FE mesh points or grid points.

In the *Stresses* tab of the *Details* dialog box, you can specify which stress components you want to display in the table.

Individual table columns are described in Chapter 5.1 *Max Stress/Ratio by Loading*.

#### Filtering result columns

For a clearer overview, you can filter the table by composition, surface and point number as well as by loading. The drop-down lists allows you to make a selection by object number. You can also specify the points and surfaces graphically in the RFEM work window after clicking [^].

Details...

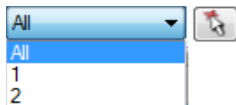

## 5.4 Line Support Reactions

2.4 Line Support Reactions

Line No.	A Surface No.	B Load- ing	C Packet/ Layer No.	D Support Location	E Location x [m]	G Support Forces [kN/m]			J Support Moments [kNm/m]		
						F p <sub>x</sub>	H p <sub>y</sub>	I p <sub>z</sub>	K m <sub>x</sub>	L m <sub>y</sub>	M m <sub>z</sub>
1	1	LC1	1	Middle	0.000	0.20	0.20	-0.04	0.00	0.00	0.00
					0.100	7.97	2.87	0.38	0.00	0.00	-0.02
					0.200	10.35	3.14	0.38	0.00	0.00	-0.01
					0.300	13.05	3.17	0.39	0.00	0.00	-0.01
					0.400	15.19	2.79	0.40	0.00	0.00	-0.01
					0.500	16.81	2.14	0.40	0.00	0.00	-0.01
					0.600	17.92	1.34	0.40	0.00	0.00	0.00
					0.700	18.47	0.46	0.40	0.00	0.00	0.00
					0.800	18.47	-0.46	0.40	0.00	0.00	0.00
					0.900	17.92	-1.34	0.40	0.00	0.00	0.00
					1.000	16.81	-2.14	0.40	0.00	0.00	0.01
					1.100	15.19	-2.79	0.40	0.00	0.00	0.01
					1.200	13.05	-3.17	0.39	0.00	0.00	0.01
					1.300	10.35	-3.14	0.38	0.00	0.00	0.01
					1.400	7.97	-2.87	0.38	0.00	0.00	0.02
1.500	2.24	-2.22	-0.44	0.00	0.00	0.00					
1	1	LC1	3	Middle	0.000	-0.20	-0.20	-0.08	0.00	0.00	0.00
					0.100	-7.98	-2.88	0.52	0.00	0.00	0.02
					0.200	-10.36	-3.15	0.93	0.00	0.00	0.01
					0.300	-13.07	-3.18	1.27	0.00	0.00	0.01
					0.400	-15.20	-2.80	1.46	0.00	0.00	0.01
					0.500	-16.83	-2.15	1.60	0.00	0.00	0.01
					0.600	-17.93	-1.34	1.68	0.00	0.00	0.00
					0.700	-18.49	-0.46	1.72	0.00	0.00	0.00
					0.800	-18.49	0.46	1.72	0.00	0.00	0.00
					0.900	-17.93	1.34	1.68	0.00	0.00	0.00
					1.000	-16.83	2.15	1.60	0.00	0.00	-0.01
					1.100	-15.20	2.80	1.46	0.00	0.00	-0.01
					1.200	-13.07	3.18	1.27	0.00	0.00	-0.01

Related to:  Local axis system x, y, z  Global axis system X, Y, Z

Line No.:  Layer No.:  Support Location:  Loading:

Figure 5.4: Window 2.4 Line Support Reactions

This results window is shown only if you select *Local* calculation type in Window 1.1. The window shows the support forces and support moments for each line support defined in the 1.3 *Line Supports* window. The table is sorted by line numbers.

### Surface No.

This column shows the numbers of the surfaces with the governing lines.

### Loading

In the column loading, you can see the load case numbers or numbers of load and result combinations.

### Packet/Layer No.

This column shows the numbers of packets or glass type layers on which the line supports are defined.

### Support Location

The column shows the exact support location.

### Location x

The  $x$ -locations shown in the table column represent the spacing of FE nodes along the line. The surface grid is not relevant for line support reactions.

### Support forces $p_x/p_y/p_z$

The support forces are listed in three table columns. The forces can be related to the global axes X, Y and Z or the local axes x, y and z of the line supports. The table shows the forces which are introduced into the support.

### Support moments $m_x/m_y/m_z$

The support moments are listed in three table columns. They are related to the global axis system XYZ or the local axis system of the line support xyz. The table shows the moments which are introduced into the support.

### Filtering result columns

For a clearer overview, you can filter the table by line and layer number, support location as well as by loading. The drop-down lists allow you to make a selection by object number. You can also specify the line graphically in the RFEM work window after clicking [↵].

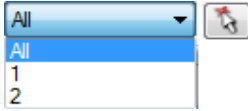

## 5.5 Nodal Support Reactions

2.5 Nodal Support Reactions

Node No.	A Surface No.	B Load- ing	C Packet/ Layer No.	D Support Location	E Support Forces [kN]			H Support Moments [kNm]		
					P <sub>x</sub>	P <sub>y</sub>	P <sub>z</sub>	M <sub>x</sub>	M <sub>y</sub>	M <sub>z</sub>
1	1	LC1	1	Middle	0.20	0.20	-0.04	0.00	0.00	0.00
1	1	LC1	3	Middle	-0.20	-0.20	-0.08	0.00	0.00	0.00
1	1	LC2	1	Middle	0.54	0.54	-0.11	0.00	0.00	0.00
1	1	LC2	3	Middle	-0.54	-0.54	-0.22	0.00	0.00	0.00
5	2	LC1: Summer	1	Top	1.15	1.11	-0.05	0.00	0.00	0.00
5	2	LC1: Summer	3	Top	1.78	1.68	-0.07	0.00	0.00	0.00
5	2	LC1: Summer	3	Middle	-0.31	-0.09	-0.19	0.00	0.00	0.00
5	2	LC1: Summer	3	Bottom	-1.31	-1.45	-0.03	0.00	0.00	0.00
5	2	LC1: Winter	1	Top	2.23	2.09	-0.09	0.00	0.00	0.00
5	2	LC1: Winter	3	Top	0.77	0.75	-0.03	0.00	0.00	0.00
5	2	LC1: Winter	3	Middle	-0.06	-0.01	0.09	0.00	0.00	0.00
5	2	LC1: Winter	3	Bottom	-0.67	-0.71	-0.02	0.00	0.00	0.00
5	2	LC2: Summer	1	Top	3.78	3.43	-0.15	0.00	0.00	0.00
5	2	LC2: Summer	3	Top	4.11	3.69	-0.16	0.00	0.00	0.00
5	2	LC2: Summer	3	Middle	-1.18	-0.36	0.36	-0.01	0.01	0.00
5	2	LC2: Summer	3	Bottom	-2.30	-2.77	0.01	0.00	0.00	0.00
5	2	LC2: Winter	1	Top	5.17	4.62	-0.20	-0.01	0.01	0.00
5	2	LC2: Winter	3	Top	2.78	2.55	-0.11	0.00	0.00	0.00
5	2	LC2: Winter	3	Middle	-0.62	-0.16	0.27	0.00	0.00	0.00
5	2	LC2: Winter	3	Bottom	-1.83	-2.09	-0.01	0.00	0.00	0.00
6	2	LC1: Summer	1	Top	1.15	1.11	-0.05	0.00	0.00	0.00
6	2	LC1: Summer	3	Top	1.78	1.68	-0.07	0.00	0.00	0.00
6	2	LC1: Summer	3	Middle	-0.31	0.09	-0.19	0.00	0.00	0.00
6	2	LC1: Summer	3	Bottom	-1.31	1.44	-0.03	0.00	0.00	0.00
6	2	LC1: Winter	1	Top	2.23	2.09	-0.09	0.00	0.00	0.00
6	2	LC1: Winter	3	Top	0.77	-0.75	-0.03	0.00	0.00	0.00
6	2	LC1: Winter	3	Middle	-0.06	0.01	0.09	0.00	0.00	0.00
6	2	LC1: Winter	3	Bottom	-0.67	0.71	-0.02	0.00	0.00	0.00
6	2	LC2: Summer	1	Top	3.78	3.43	-0.15	0.00	0.00	0.00
6	2	LC2: Summer	3	Top	4.11	3.69	-0.16	0.00	0.00	0.00

Related to:  Local axis system X', Y', Z  Global axis system X, Y, Z

Node No.:  Layer No.:  Support Location:  Loading:

Figure 5.5: Window 2.5 Nodal Support Reactions

This results window is shown only if you select the *Local* calculation type in Window 1.1. The window shows the support forces and support moments for each nodal support defined in the 1.4 Nodal Supports window. The table is sorted by node numbers.

The columns of this table are described in Chapter 5.4.

## 5.6 Max Displacements

3.1 Max Displacements

Surface No.	A Point No.	B Point Coordinates [m]			E Load- ing	F Type of Comb.	G Packet No.	H Displacements [mm]		J Ratio $u_z$ [-]
		X	Y	Z				$u_z$	Limit $u_z$	
1	89	0.500	0.800	0.000	LC1	CH	1	0.864	15.000	0.06
	89	0.500	0.800	0.000	LC2	CH	1	2.301	15.000	0.15
2	292	2.000	1.000	0.000	LC1: Summer	CH	1	2.754	10.000	0.28
	292	2.000	1.000	0.000			2	4.213	10.000	0.42
	292	2.000	1.000	0.000	LC1: Winter	CH	1	4.919	10.000	0.49
	292	2.000	1.000	0.000			2	1.991	10.000	0.20
	292	2.000	1.000	0.000	LC2: Summer	CH	1	7.486	10.000	0.75
	292	2.000	1.000	0.000			2	8.162	10.000	0.82
	292	2.000	1.000	0.000	LC2: Winter	CH	1	9.430	10.000	0.94
	292	2.000	1.000	0.000			2	6.052	10.000	0.61
Maximum Displacement / Maximum Displacement Ratio										
	292	2.000	1.000	0.000	LC2: Winter	CH	1	9.430	10.000	0.94
	292	2.000	1.000	0.000	LC2: Winter	CH	1	9.430	10.000	0.94

Max ratio: 0.94 ≤ 1

Figure 5.6: Window 3.1 Max Displacements

The deformation analyses are carried out only if you selected at least one load case for design in the *Serviceability Limit State* tab of the 1.1 *General Data* dialog box (see Chapter 3.1.2, page 22).

Window 3.1 shows the maximum displacements from load cases or load combinations for the serviceability limit state and compares them with the allowable deformations. The table is sorted by surface numbers.

The columns A to D are described in Chapter 5.1 on page 56.

### Type of Comb.

The column shows the design combinations assigned in the *Serviceability Limit State* tab of the 1.1 *General Data* window: Characteristic (CH), Frequent (FR), or Quasi-permanent (QP).

### Displacements

In the column  $u_z$ , you can see the displacements in the direction of the local surface axis  $z$ , which are governing for the deformation analysis. You can display the axes of the surfaces by using the *Display* navigator of RFEM or by using the context menu of the surfaces.

The values in column I show the limit deformations in the direction of the  $z$ -axis of each surface. These values are determined from the reference lengths  $L$ , which are specified in the 1.8 *Serviceability Data* window (see Chapter 3.8, page 38), and from the limit values defined for the serviceability design in the *Standard* dialog box (see Chapter 4.3).

### Ratio

The last column shows the quotients from the resulting displacement  $u_z$  (column H) and the limit displacement (column I). If the limit deformations are not exceeded, then the ratio is less than or equal to 1 and the deformation design is satisfied.

Max ratio: 0.94 ≤ 1

## 5.7 Gas Pressure

3.2 Gas Pressure

Load- ing	A Surface No.	B Layer No.	C Gas Pressure p [kN/m <sup>2</sup> ]
LC1	Summer, Self-Weigh		
	2	2	103.49
LC1	Winter, Self-Weigh		
	2	2	104.01
LC2	Summer		
	2	2	106.80
LC2	Winter		
	2	2	107.08

Figure 5.7: Window 3.2 Gas Pressure

This results window is shown only if you defined at least one gas layer in the 1.2 Layers window. The Gas Pressure results for the gas layers are listed by load case.

## 5.8 Parts List

4.1 Parts List

Surface No.	A Material Description	B Thickness t [mm]	C No. of Layers	D Area [m <sup>2</sup> ]	E Coating [m <sup>2</sup> ]	F Volume [m <sup>3</sup> ]	G Weight [t]
1	Thermally Toughened Float Glass	10.00	2	1.500	3.000	0.030	0.075
	PVB 22 °C loading until 3 min	0.38	1	1.500	0.000	0.001	0.001
	Σ	20.38	3	1.500	3.000	0.031	0.076
2	Thermally Toughened Float Glass	10.00	2	2.000	4.000	0.040	0.100
	Dry Air	10.00	1	2.000	0.000	0.020	0.000
	Σ	30.00	3	2.000	4.000	0.060	0.100
Σ Total				3.500	7.000	0.091	0.176

Figure 5.8: Window 4.1 Parts List

The last results window shows an overall review of the designed surfaces. By default, the data in this list refers only to designed surfaces. If you wish to display the parts list for all surfaces in the model, you can set this in the *Results* tab of the *Details* dialog box (Chapter 4.1.2, page 45).

### **Surface No.**

This column contains the numbers of individual surfaces.

### **Material Description**

The data is listed by materials.

### **Thickness t**

Column B shows the thickness of the layers. You can find this input data in the 1.2 *Layers* window.

### **No. of Layers**

This column shows the number of layers with the same material and the same thickness.

### **Area**

The column provides information on the surface areas of the individual layers.

### **Coating**

The total surface coating is determined from the top and bottom sides of a surface. The side surfaces of the thin-walled surfaces are neglected.

### **Volume**

The volume is calculated as the product of thickness and surface area.

### **Weight**

The last column displays the weight of every layer. This entry is determined as product of the volume and specific weight of the used material.

### **$\Sigma$ Total**

In the last table row, you can see the total sums of individual columns.



## 6. Printout

### 6.1 Printout Report

As usual in RFEM, a printout report is created for the design results in RF-GLASS, to which you can add graphics and explanations. In the global selection, you can select input and output data of RF-GLASS that you want to include in the printout report.



The printout report is described in detail in the RFEM manual. Chapter 10.1.3.4 *Selecting Data of Add-on Modules* describes how to prepare the input and output data of add-on modules for the printout.



The printout report shows only the stress types that appear in the RF-GLASS output windows. Therefore, if you want to print for example the maximum shear stresses, you must activate the display of the stresses  $\tau_{\max}$  in RF-GLASS. The selection of stresses is described in Chapter 4.1.1, page 40.

For complicated structural systems with a great number of design cases, it is recommended to divide the data into several printout reports to get a better overview.

### 6.2 Printing RF-GLASS Graphics

#### 6.2.1 Results on the RFEM Model

In RFEM, you can transfer every image shown in the work window to the printout report or send it directly to a printer. In the same way, you can also prepare the stresses, ratios, and sections shown on the RFEM model for the printout report.



Printing graphics is described in Chapter 10.2 of the RFEM manual.



You can print the current graphic of the RF-GLASS results in the RFEM work window by using the command from the main menu

**File → Print Graphic**

or clicking the corresponding button in the toolbar.

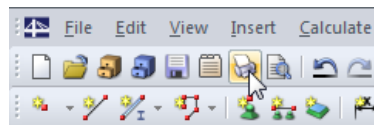

Figure 6.1: Button *Print Graphic* in the RFEM toolbar

The following dialog box opens.

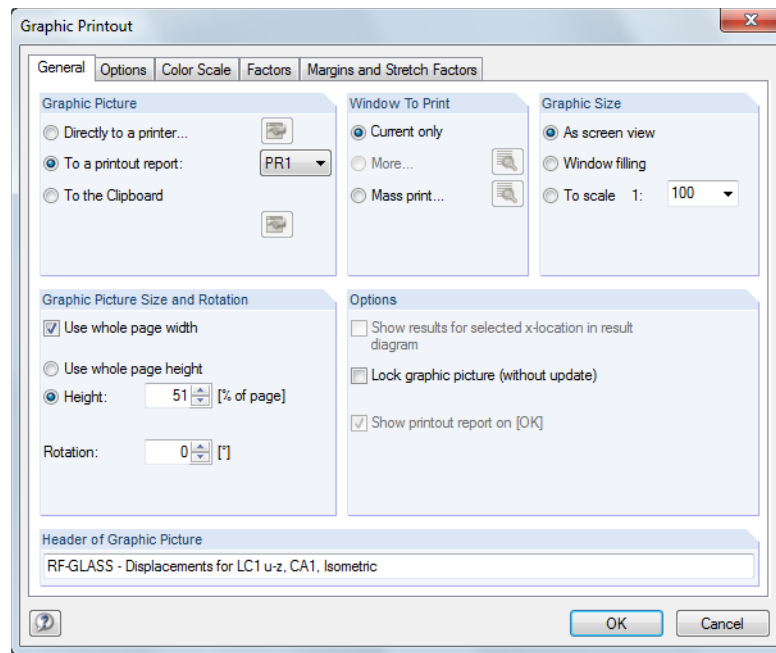

Figure 6.2: Dialog box *Graphic Printout*, tab *General*

This dialog box is described in Chapter 10.2 of the RFEM manual. The other tabs *Options* and *Color Scale* are described there as well.

You can move a graphic to another place in the printout report by using the drag-and-drop operation as usual.

To adjust an inserted graphic in the printout report subsequently, right-click the appropriate item in the navigator of the report. By using the *Properties* option in the context menu, you re-open the *Graphic Printout*, where you can modify the settings.

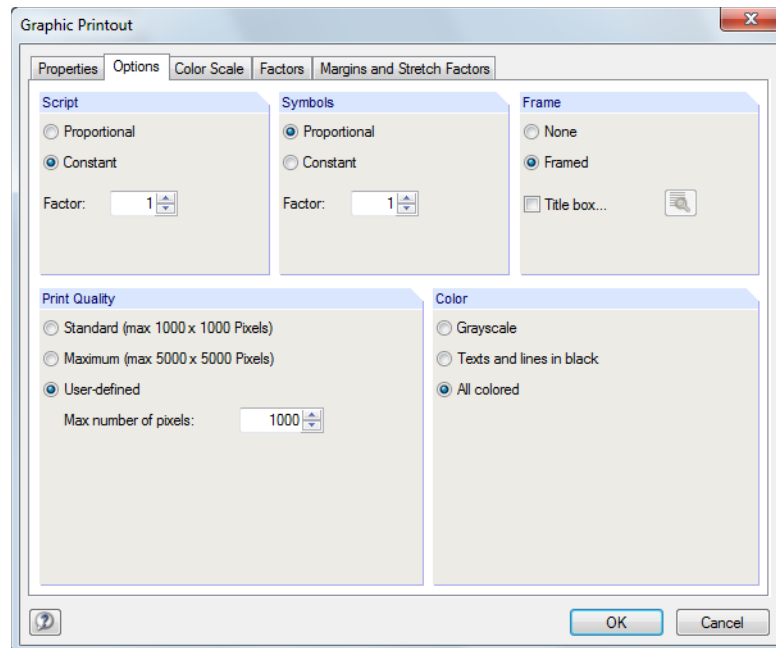
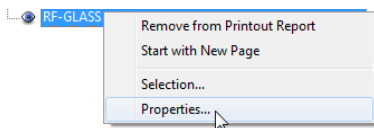

Figure 6.3: Dialog box *Graphic Printout*, tab *Options*

### 6.2.2 Results in Layers

Results Windows 2.1 through 2.3 show the stress distribution in the layers. The stress graphics can be added to the printout report by selecting the *Graph in Printout Report* check boxes in column M.

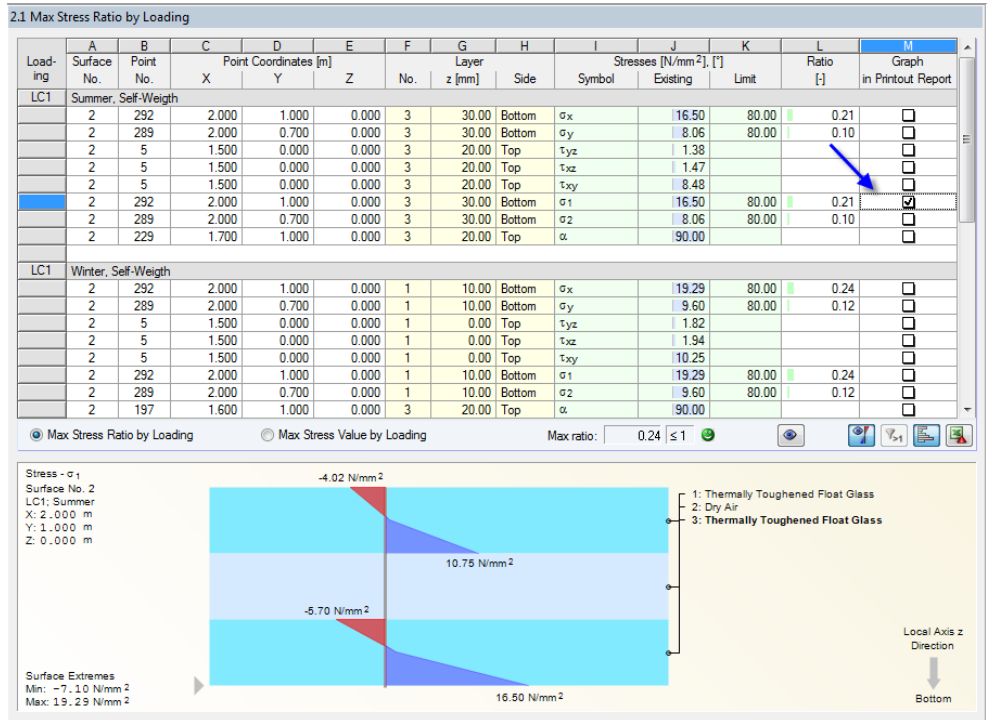

Figure 6.4: Specifying *Diagram in Printout Report*

The graphics then appear in the 4.2 *Stress Diagrams* sections of the printout report.

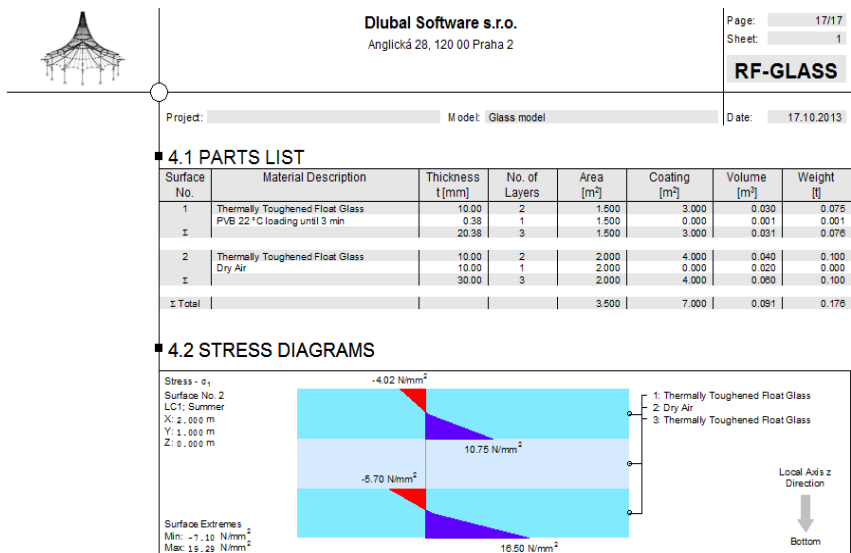

Figure 6.5: Stress diagram in printout report

# 7. General Functions

This chapter describes useful functions from the main menu and export options for design results.

## 7.1 Units and Decimal Places

The units and decimal places are managed in one dialog box for RFEM and the add-on modules. In RF-GLASS, you open the dialog box for adjusting the units by using the command from the menu

**Settings** → **Units and Decimal Places**.

The dialog box familiar from RFEM opens. RF-GLASS is already preset in the *Program/Module* list.

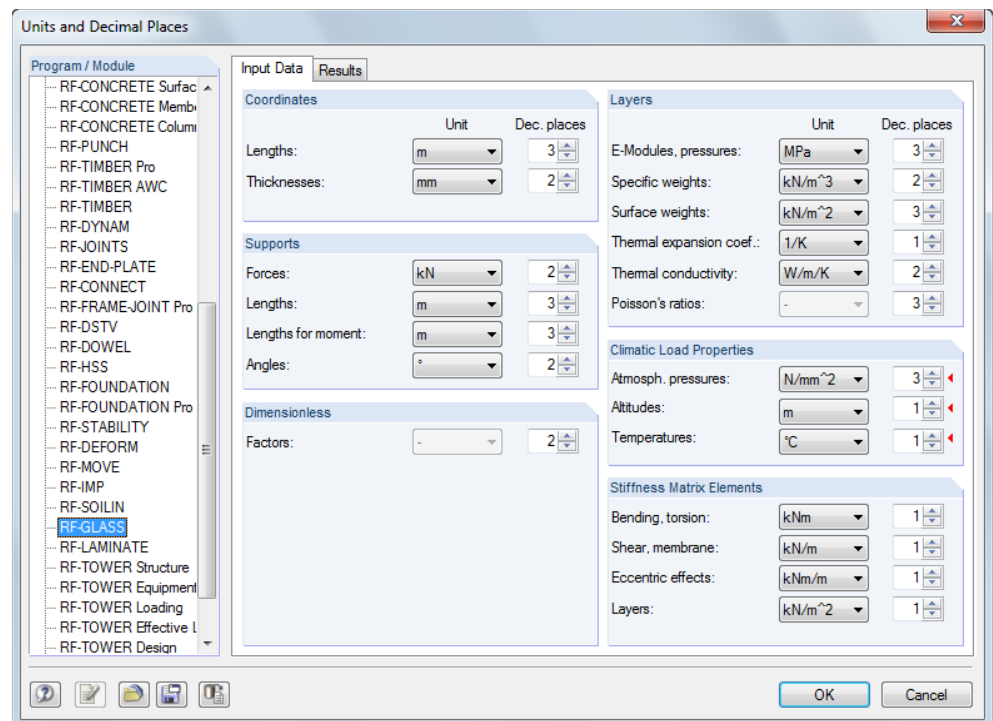

Figure 7.1: Dialog box *Units and Decimal Places*

In the figure above, some units are marked by a red triangle (section *Climatic Load Properties*). The dialog box was opened from the 1.6 *Climatic Load Parameters* window. These marks allow you to find the relevant units of this window more easily.



You can save the settings as a user profile and reuse them in other models. This functions are described in Chapter 11.1.3 of the RFEM manual.

## 7.2 Export of Results

You can export the results to other programs in a variety of ways.

### Clipboard

You can copy the marked rows of a results window to the Clipboard by using the buttons [Ctrl]+[C], and then transfer them, for example, to a word processor by using [Ctrl]+[V]. The headings of table columns are not exported.

### Printout Report

RF-GLASS data can be printed in the printout report (Chapter 6.1, page 65), and then exported by using the command from the menu

**File** → **Export to RTF**.

This function is described in Chapter 10.1.11 of the RFEM manual.

### Excel / OpenOffice

RF-GLASS allows for a direct export of data to MS Excel, OpenOffice.org Calc, or the CSV format. You call up this function from the RF-GLASS menu

**File** → **Export Tables**.

The following dialog box for the data export opens:

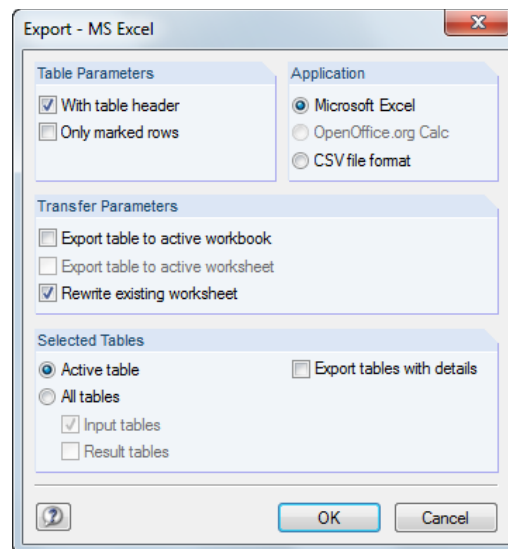

Figure 7.2: Dialog box *Export – MS Excel*

Having selected the required parameters, you can start the export by clicking [OK]. Excel or OpenOffice are started automatically, that is, the programs do not need to run in the background.

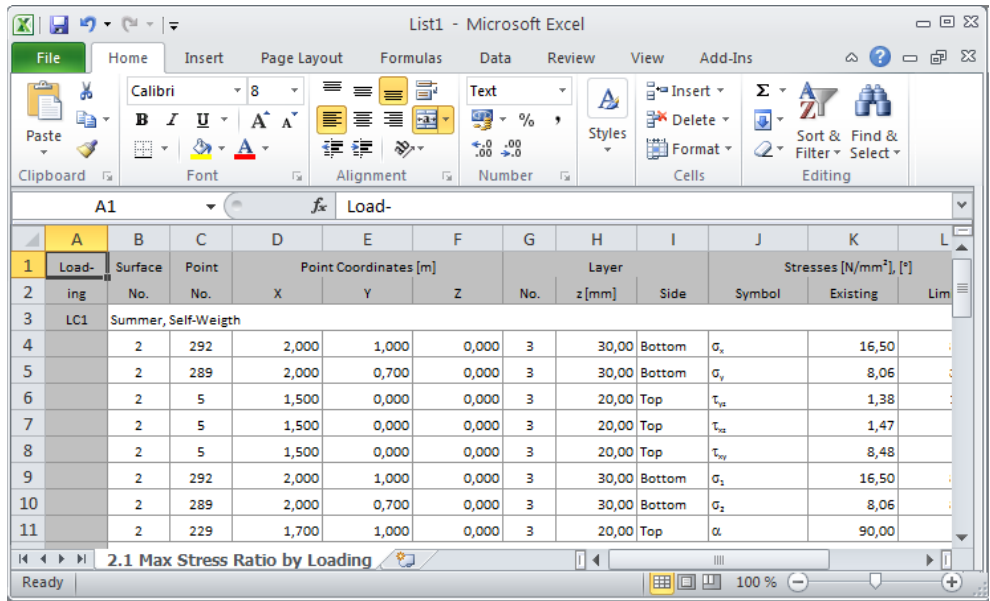

Figure 7.3: Results in Excel – window 2.1 Max Stress by Load Case

### 7.3 Connection to RFEM

If a surface of the type *Glass* is created in RFEM, this surface has to be defined in RF-GLASS. When the *Local* calculation type is selected in the 1.1 *General Data* window, the data defined in RF-GLASS is used only for this module. It does not influence RFEM specifications. In the main program, each surface is described by the specification of the *Material* and the *Thickness*. When the *Global* calculation type is selected in the 1.1 *General Data* window, the stiffness of the surfaces defined in RF-GLASS is transferred to RFEM.

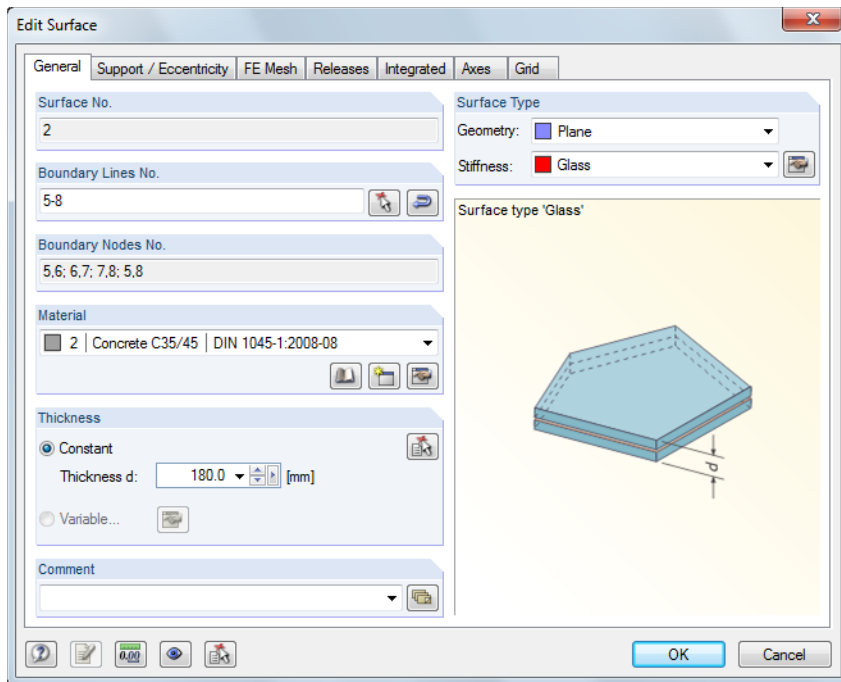

Figure 7.4: Dialog box Edit Surface

# 8. Examples

Various examples are introduced in the following chapter.

## 8.1 Determination of Stiffness Matrix Elements

Consider a plate consisting of the following layers: A thermally toughened glass pane with a thickness of 12 mm, a PVB foil with a thickness of 1.14 mm, and of a thermally toughened glass pane with a thickness of 10 mm.

Shear coupling of layers is taken into account.

Furthermore, consider the calculation according to the 2D plate theory.

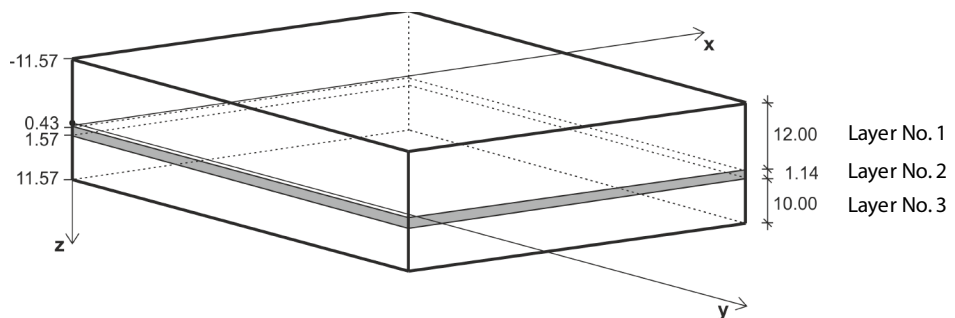

Figure 8.1: Layer composition

Layers									
Layer No.	A Layer Type	B Material Description	C Thickness t [mm]	D Modulus of Elast. E [N/mm <sup>2</sup> ]	E Shear Modulus G [N/mm <sup>2</sup> ]	F Poisson's Ratio ν [.]	G Specific Weight γ [kN/m <sup>3</sup> ]	H Coeff. of Th. Exp. α <sub>T</sub> [1/K]	I Limit Stress σ <sub>limit</sub> [N/mm <sup>2</sup> ]
1	Glass	Thermally Toughened Float Glass	12.00	70000.000	28455.300	0.230	25.00	9.0E-06	120.000
2	Foil	PVB 22 °C loading until 10 sec	1.14	12.000	4.003	0.499	10.70	8.0E-05	
3	Glass	Thermally Toughened Float Glass	10.00	70000.000	28455.300	0.230	25.00	9.0E-06	120.000

Figure 8.2: Window 1.2 Layers

The stiffness matrix of the individual layers is determined as follows:

$$d_i = \begin{bmatrix} d_{11,i} & d_{12,i} & 0 \\ & d_{22,i} & 0 \\ \text{sym.} & & d_{33,i} \end{bmatrix} = \begin{bmatrix} \frac{E_i}{1-\nu_i^2} & \frac{\nu_i E_i}{1-\nu_i^2} & 0 \\ & \frac{E_i}{1-\nu_i^2} & 0 \\ \text{sym.} & & G_i \end{bmatrix}, \quad G_i = \frac{E_i}{2 \cdot (1 + \nu_i)} \quad i = 1, \dots, n \quad (8.1)$$

$$d_1 = \begin{bmatrix} \frac{70000}{1-0.23^2} & \frac{0.23 \cdot 70000}{1-0.23^2} & 0 \\ & \frac{70000}{1-0.23^2} & 0 \\ \text{sym.} & & 28455.3 \end{bmatrix} = \begin{bmatrix} 73909.8 & 16999.3 & 0 \\ 16999.3 & 73909.8 & 0 \\ 0 & 0 & 28455.3 \end{bmatrix} \text{ MN/m}^2$$

Matrix Elements					
d11:	73909.8	[MN/m <sup>2</sup> ]	d12:	16999.3	[MN/m <sup>2</sup> ]
			d22:	73909.8	[MN/m <sup>2</sup> ]
			d33:	28455.3	[MN/m <sup>2</sup> ]

Figure 8.3: Stiffness matrix of layer No. 1

$$d_2 = \begin{bmatrix} \frac{12}{1-0.499^2} & \frac{0.499 \cdot 12}{1-0.499^2} & 0 \\ \text{sym.} & \frac{12}{1-0.499^2} & 0 \\ & & 4.0 \end{bmatrix} = \begin{bmatrix} 15.98 & 7.97 & 0 \\ 7.97 & 15.98 & 0 \\ 0 & 0 & 4.00 \end{bmatrix} \text{ MN/m}^2$$

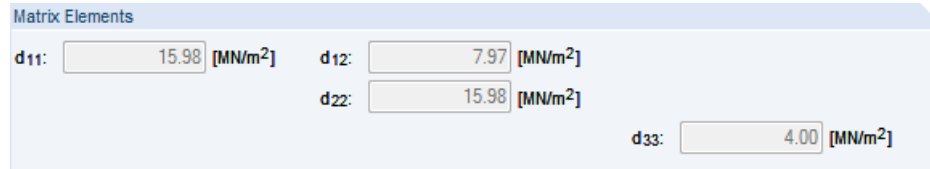

Figure 8.4: Stiffness matrix of layer No. 2

$$d_3 = d_1 = \begin{bmatrix} \frac{70000}{1-0.23^2} & \frac{0.23 \cdot 70000}{1-0.23^2} & 0 \\ \text{sym.} & \frac{70000}{1-0.23^2} & 0 \\ & & 28455.3 \end{bmatrix} = \begin{bmatrix} 73909.8 & 16999.3 & 0 \\ 16999.3 & 73909.8 & 0 \\ 0 & 0 & 28455.3 \end{bmatrix} \text{ MN/m}^2$$

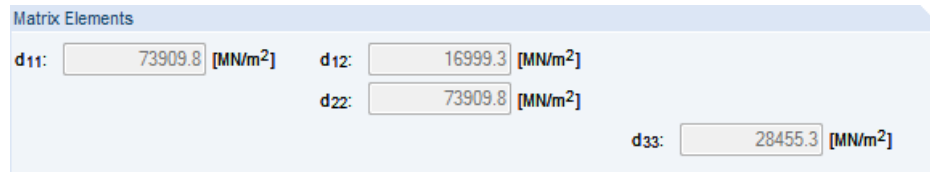

Figure 8.5: Stiffness matrix of layer No. 3

Then, the global stiffness matrix has the following shape:

$$D = \begin{bmatrix} D_{11} & D_{12} & 0 & 0 & 0 & D_{16} & D_{17} & 0 \\ & D_{22} & 0 & 0 & 0 & \text{sym.} & D_{27} & 0 \\ & & D_{33} & 0 & 0 & \text{sym.} & \text{sym.} & D_{38} \\ & & & D_{44} & 0 & 0 & 0 & 0 \\ & & & & D_{55} & 0 & 0 & 0 \\ & \text{sym.} & & & & D_{66} & D_{67} & 0 \\ & & & & & & D_{77} & 0 \\ & & & & & & & D_{88} \end{bmatrix} \quad (8.2)$$

The determination of the stiffness matrix elements is described on the following pages.

**Stiffness matrix elements (bending and torsion) [N/m]**

$$D_{11} = \sum_{i=1}^n \frac{z_{\max,i}^3 - z_{\min,i}^3}{3} d_{11,i}$$

$$D_{12} = \sum_{i=1}^n \frac{z_{\max,i}^3 - z_{\min,i}^3}{3} d_{12,i}$$

$$D_{22} = \sum_{i=1}^n \frac{z_{\max,i}^3 - z_{\min,i}^3}{3} d_{22,i}$$

$$D_{33} = \sum_{i=1}^n \frac{z_{\max,i}^3 - z_{\min,i}^3}{3} d_{33,i}$$



$$D_{11} = \frac{(0.43 \cdot 10^{-3})^3 - (-11.57 \cdot 10^{-3})^3}{3} 73909.8 \cdot 10^3 + \frac{(1.57 \cdot 10^{-3})^3 - (0.43 \cdot 10^{-3})^3}{3} 15.98 \cdot 10^3 + \frac{(11.57 \cdot 10^{-3})^3 - (1.57 \cdot 10^{-3})^3}{3} 73909.8 \cdot 10^3 = 76.2 \text{ Nm}$$

$$D_{12} = \frac{(0.43 \cdot 10^{-3})^3 - (-11.57 \cdot 10^{-3})^3}{3} 16999.3 \cdot 10^3 + \frac{(1.57 \cdot 10^{-3})^3 - (0.43 \cdot 10^{-3})^3}{3} 7.97 \cdot 10^3 + \frac{(11.57 \cdot 10^{-3})^3 - (1.57 \cdot 10^{-3})^3}{3} 16999.3 \cdot 10^3 = 17.5 \text{ Nm}$$

$$D_{22} = \frac{(0.43 \cdot 10^{-3})^3 - (-11.57 \cdot 10^{-3})^3}{3} 73909.8 \cdot 10^3 + \frac{(1.57 \cdot 10^{-3})^3 - (0.43 \cdot 10^{-3})^3}{3} 15.98 \cdot 10^3 + \frac{(11.57 \cdot 10^{-3})^3 - (1.57 \cdot 10^{-3})^3}{3} 73909.8 \cdot 10^3 = 76.2 \text{ Nm}$$

$$D_{33} = \frac{(0.43 \cdot 10^{-3})^3 - (-11.57 \cdot 10^{-3})^3}{3} 28455.3 \cdot 10^3 + \frac{(1.57 \cdot 10^{-3})^3 - (0.43 \cdot 10^{-3})^3}{3} 4.0 \cdot 10^3 + \frac{(11.57 \cdot 10^{-3})^3 - (1.57 \cdot 10^{-3})^3}{3} 28455.3 \cdot 10^3 = 29.3 \text{ Nm}$$

#### Stiffness matrix elements (eccentric effects) [N/m]

$$D_{16} = \sum_{i=1}^n \frac{z_{\max,i}^2 - z_{\min,i}^2}{2} d_{11,i}$$

$$D_{17} = \sum_{i=1}^n \frac{z_{\max,i}^2 - z_{\min,i}^2}{2} d_{12,i}$$

$$D_{27} = \sum_{i=1}^n \frac{z_{\max,i}^2 - z_{\min,i}^2}{2} d_{22,i}$$

$$D_{38} = \sum_{i=1}^n \frac{z_{\max,i}^2 - z_{\min,i}^2}{2} d_{33,i}$$

$$D_{16} = \frac{(0.43 \cdot 10^{-3})^2 - (-11.57 \cdot 10^{-3})^2}{2} 73909.8 \cdot 10^3 + \frac{(1.57 \cdot 10^{-3})^2 - (0.43 \cdot 10^{-3})^2}{2} 15.98 \cdot 10^3 + \frac{(11.57 \cdot 10^{-3})^2 - (1.57 \cdot 10^{-3})^2}{2} 73909.8 \cdot 10^3 = -84.2 \text{ Nm/m}$$

$$D_{17} = \frac{(0.43 \cdot 10^{-3})^2 - (-11.57 \cdot 10^{-3})^2}{2} 16999.3 \cdot 10^3 + \frac{(1.57 \cdot 10^{-3})^2 - (0.43 \cdot 10^{-3})^2}{2} 7.97 \cdot 10^3 + \frac{(11.57 \cdot 10^{-3})^2 - (1.57 \cdot 10^{-3})^2}{2} 16999.3 \cdot 10^3 = -19.4 \text{ Nm/m}$$

$$D_{27} = \frac{(0.43 \cdot 10^{-3})^2 - (-11.57 \cdot 10^{-3})^2}{2} 73909.8 \cdot 10^3 + \frac{(1.57 \cdot 10^{-3})^2 - (0.43 \cdot 10^{-3})^2}{2} 15.98 \cdot 10^3 + \frac{(11.57 \cdot 10^{-3})^2 - (1.57 \cdot 10^{-3})^2}{2} 73909.8 \cdot 10^3 = -84.2 \text{ Nm/m}$$

$$D_{38} = \frac{(0.43 \cdot 10^{-3})^2 - (-11.57 \cdot 10^{-3})^2}{2} 28455.3 \cdot 10^3 + \frac{(1.57 \cdot 10^{-3})^2 - (0.43 \cdot 10^{-3})^2}{2} 4.0 \cdot 10^3 + \frac{(11.57 \cdot 10^{-3})^2 - (1.57 \cdot 10^{-3})^2}{2} 28455.3 \cdot 10^3 = -32.4 \text{ Nm/m}$$

**Stiffness matrix elements (membrane) [N/m]**

$$D_{66} = \sum_{i=1}^n t_i d_{11,i}$$

$$D_{67} = \sum_{i=1}^n t_i d_{12,i}$$

$$D_{77} = \sum_{i=1}^n t_i d_{22,i}$$

$$D_{88} = \sum_{i=1}^n t_i d_{33,i}$$

$$D_{66} = 12 \cdot 10^{-3} \cdot 73909.8 \cdot 10^3 + 1.14 \cdot 10^{-3} \cdot 15.98 \cdot 10^3 + 10 \cdot 10^{-3} \cdot 73909.8 \cdot 10^3 = 1626030 \text{ N/m}$$

$$D_{67} = 12 \cdot 10^{-3} \cdot 16999.3 \cdot 10^3 + 1.14 \cdot 10^{-3} \cdot 7.97 \cdot 10^3 + 10 \cdot 10^{-3} \cdot 16999.3 \cdot 10^3 = 373993 \text{ N/m}$$

$$D_{77} = 12 \cdot 10^{-3} \cdot 73909.8 \cdot 10^3 + 1.14 \cdot 10^{-3} \cdot 15.98 \cdot 10^3 + 10 \cdot 10^{-3} \cdot 73909.8 \cdot 10^3 = 1626030 \text{ N/m}$$

$$D_{88} = 12 \cdot 10^{-3} \cdot 28455.3 \cdot 10^3 + 1.14 \cdot 10^{-3} \cdot 4.0 \cdot 10^3 + 10 \cdot 10^{-3} \cdot 28455.3 \cdot 10^3 = 626021 \text{ N/m}$$

**Stiffness matrix elements (shear) [N/m]**

$$D_{44/55,calc} = \frac{1}{\int_{-t/2}^{t/2} G(z) \left( \frac{\int_{-t/2}^{t/2} d_{11}(\bar{z})(\bar{z}-z_0) d\bar{z}}{\int_{-t/2}^{t/2} d_{11}(\bar{z})(\bar{z}-z_0)^2 d\bar{z}} \right)^2 dz}, z_0 = \frac{\int_{-t/2}^{t/2} d_{11}(\bar{z}) \bar{z} d\bar{z}}{\int_{-t/2}^{t/2} d_{11}(\bar{z}) d\bar{z}} \quad (8.3)$$

$$D_{44,calc} = D_{55,calc} = 850.32 \text{ kN/m}$$

$$D_{44} = D_{55} = \max \left( D_{44/55,calc}, \frac{48}{5 \cdot l^2} \frac{1}{\frac{\sum_{i=1}^n E_i t_i^3}{12} - \frac{\sum_{i=1}^n E_i \frac{z_{max,i}^3 - z_{min,i}^3}{3}}} \right) \quad (8.4)$$

$$\sum_{i=1}^n E_i \frac{t_i^3}{12} = 70000 \cdot 10^3 \frac{(12 \cdot 10^{-3})^3}{12} + 12 \cdot 10^3 \frac{(1.14 \cdot 10^{-3})^3}{12} + 70000 \cdot 10^3 \frac{(10 \cdot 10^{-3})^3}{12} = 15.913 \text{ kNm}$$

$$\sum_{i=1}^n E_i \frac{z_{max,i}^3 - z_{min,i}^3}{3} =$$

$$= 70000 \cdot 10^3 \frac{(0.43 \cdot 10^{-3})^3 - (-11.57 \cdot 10^{-3})^3}{3} + 12 \cdot 10^3 \frac{(1.57 \cdot 10^{-3})^3 - (0.43 \cdot 10^{-3})^3}{3} +$$

$$+ 70000 \cdot 10^3 \frac{(11.57 \cdot 10^{-3})^3 - (1.57 \cdot 10^{-3})^3}{3} = 72.190 \text{ kNm}$$

$$D_{44} = D_{55} = \max \left( 850.32, \frac{48}{5 \cdot 1^2} \frac{1}{\frac{15.913}{12} - \frac{72.190}{3}} \right) = \max(850.32, 195.97) = 850.32 \text{ kN/m}$$

Global stiffness matrix

$$D = \begin{bmatrix} 76.2 & 17.5 & 0 & 0 & 0 & -84.2 & -19.4 & 0 \\ & 76.2 & 0 & 0 & 0 & -19.4 & -84.2 & 0 \\ & & 29.3 & 0 & 0 & 0 & 0 & -32.4 \\ & & & 850.32 & 0 & 0 & 0 & 0 \\ & & & & 850.32 & 0 & 0 & 0 \\ & \text{sym.} & & & & 1626030 & 373993 & 0 \\ & & & & & & 1626030 & 0 \\ & & & & & & & 626021 \end{bmatrix}$$

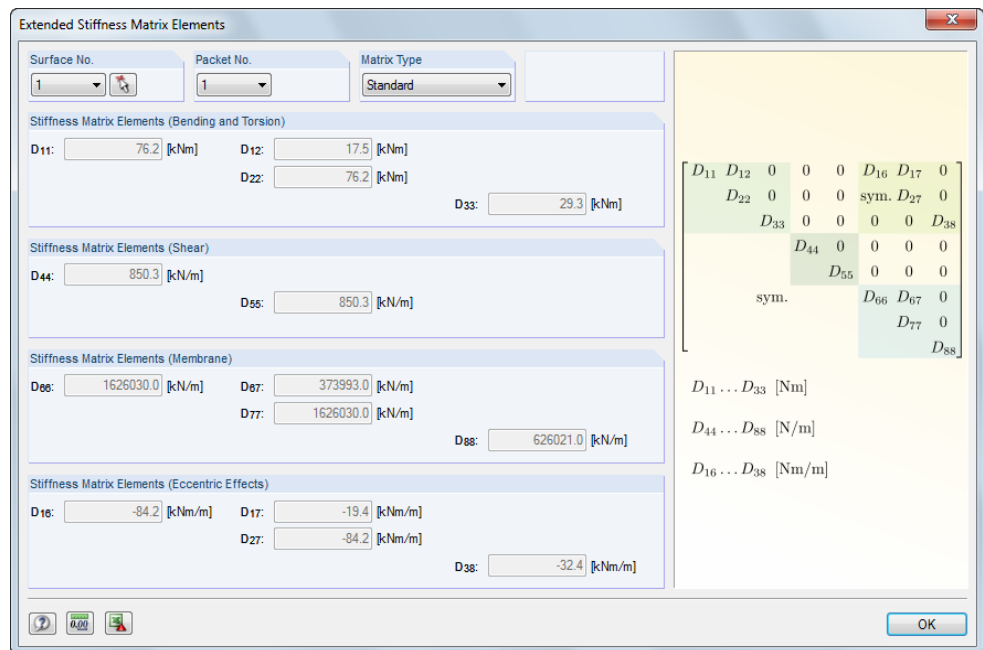

Figure 8.6: Dialog box *Extended Stiffness Matrix Elements*

## 8.2 Insulating glass

Consider an insulating glass with the dimensions 1.0 x 1.5 m, with a hinged support, and a composition according to Figure 8.7 as well as the following parameters:

Glass pane dimension in $x$ -axis direction		$a = 1.0$ m	
Glass pane dimension in $y$ -axis direction		$b = 1.5$ m	
Thickness of external glass layer		$t_1 = 8$ mm	
Thickness of air layer		$t_2 = 12$ mm	
Thickness of internal glass layer		$t_3 = 12$ mm	
Glass parameters	Modulus of elasticity	$E = 70000$ MPa	
	Shear modulus	$G = 28455$ MPa	
	Poisson's ratio	$\nu = 0.23$	
Climatic load	Manufacturing	Temperature	$T_p = 0^\circ\text{C}$
		Atmospheric pressure	$p_{p,met} = 101$ kPa
		Sea level	$H_1 = 0$ m
	Mount	Temperature (external = gas = internal)	$T_1 = 25^\circ\text{C}$
		Atmospheric pressure	$p_{out,met} = 97$ kPa
		Sea level	$H_2 = 100$ m

Table 8.1: Parameters of insulating glass

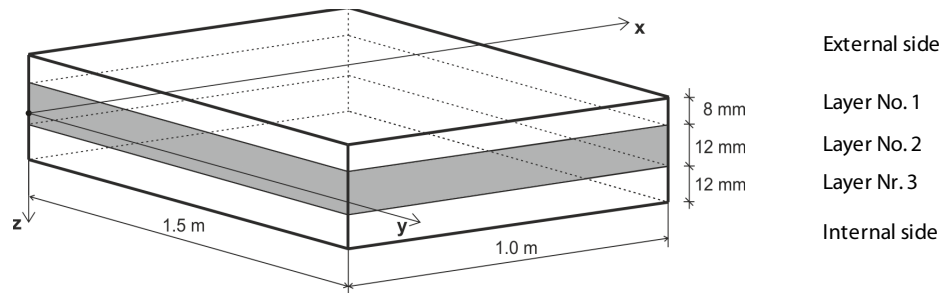

Figure 8.7: Layer composition

The length of the finite elements is 50 mm.

### 8.2.1 Calculation in RF-GLASS



First, create a *New Model* in RFEM.

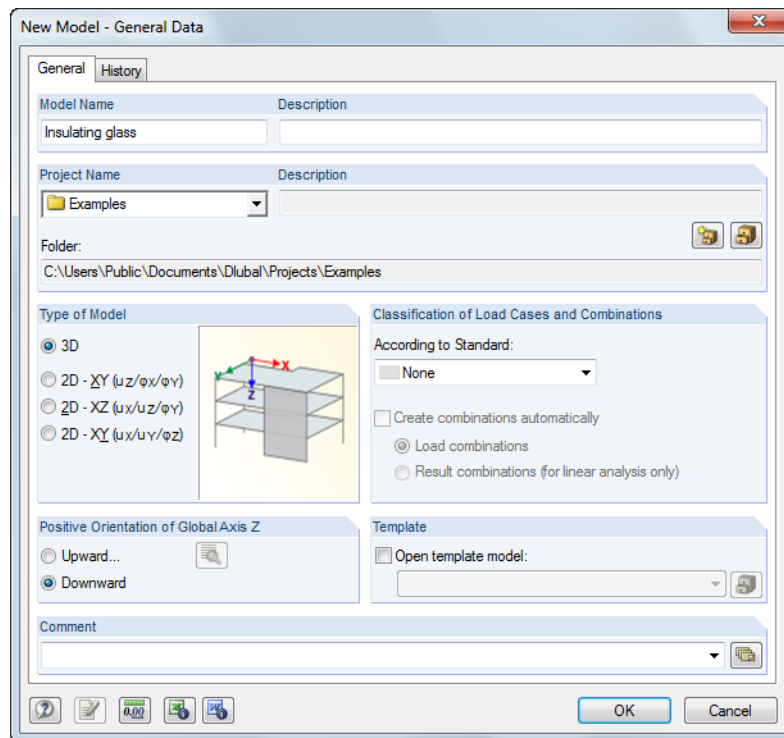

Figure 8.8: Dialog box *New Model - General Data*



Having entered the general data, you then create a *New Rectangular Surface*: Select *Glass* as surface type, and then define a surface with the dimensions 1.0 m x 1.5 m.

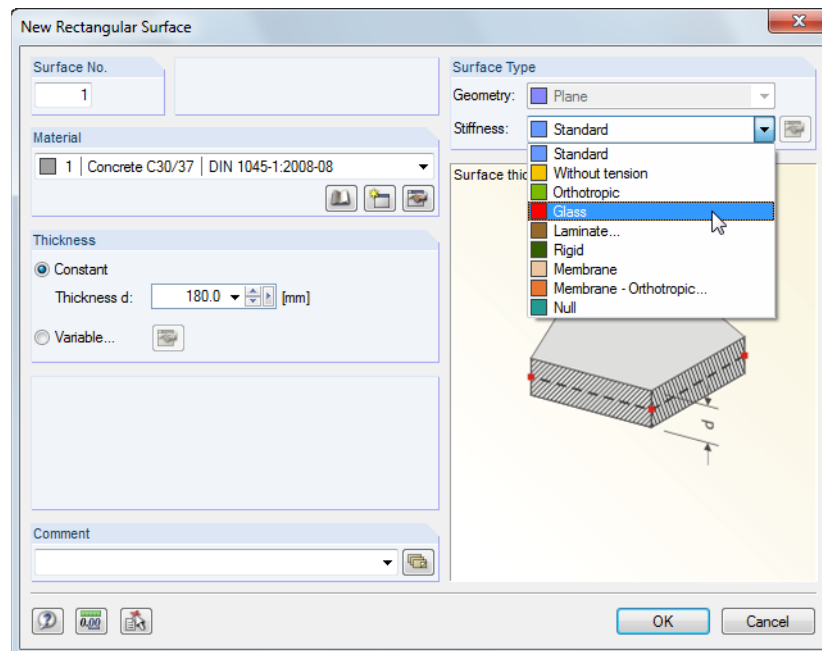

Figure 8.9: Dialog box *New Rectangular Surface*

Because you want to carry out the *Local* calculation type in RF-GLASS, the supports are defined directly in the module. Therefore, it is not necessary to define any supports in RFEM.



Although there is no external loading on the model, you have to create a load case to start the calculation in RF-GLASS. The self-weight should **not** be Active.

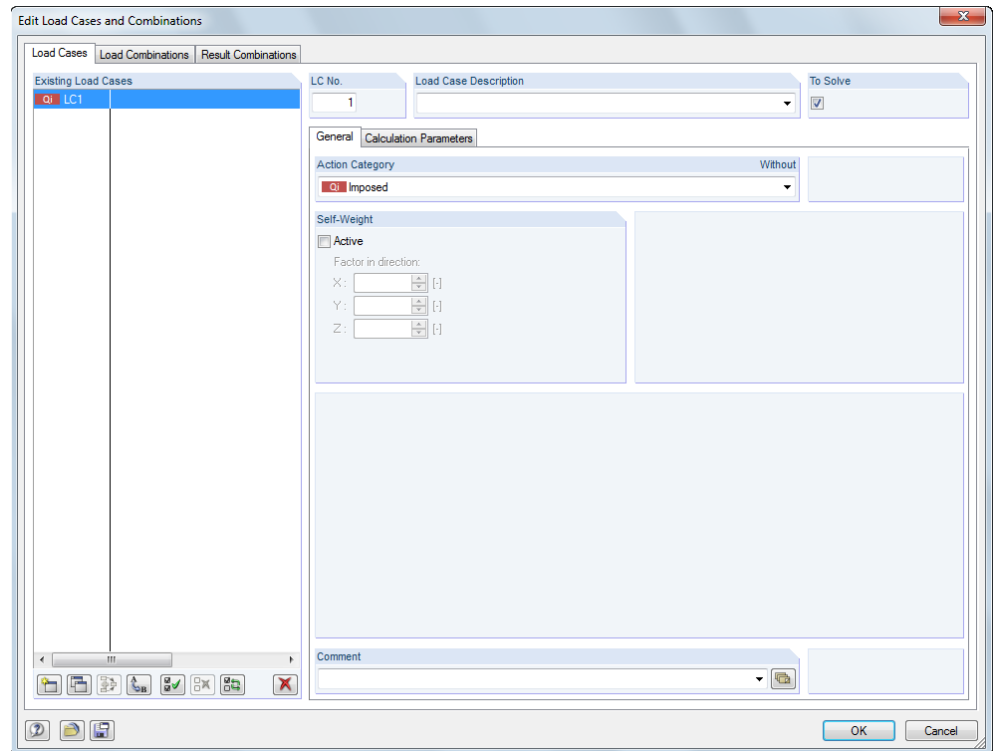

Figure 8.10: Dialog box *Edit Load Cases and Combinations*

In the *FE Mesh Settings* dialog box, set the required length of finite elements to **0.05 m**.

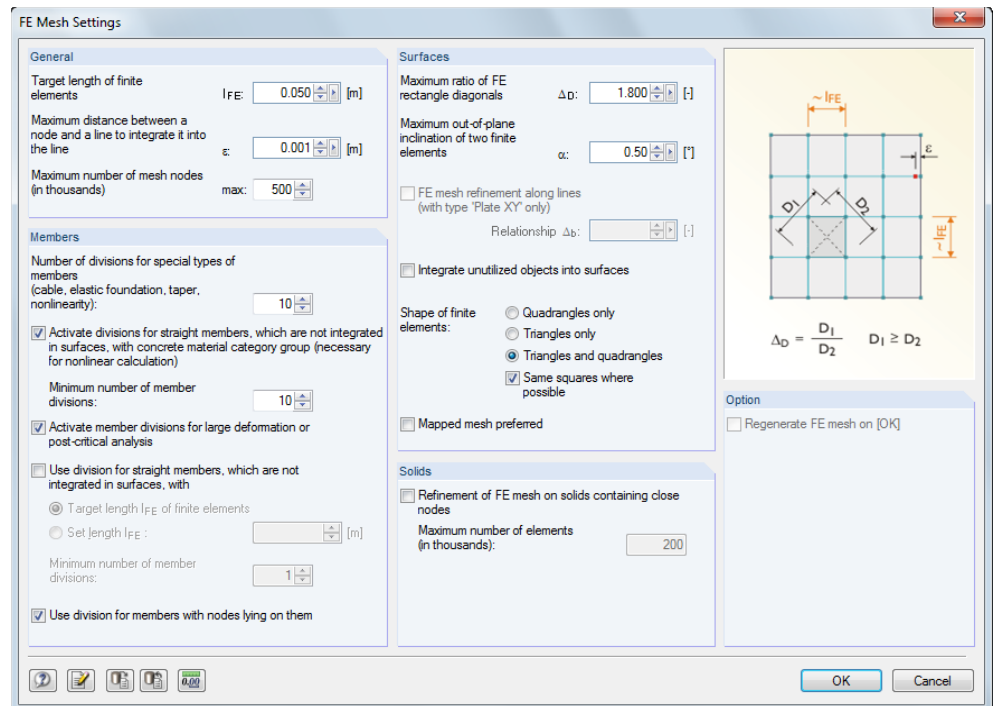

Figure 8.11: Dialog box *FE Mesh Settings*

Next, start the RF-GLASS module (see Chapter 1.4).

Because you want to create insulating glass, you should select the *Local – Individual glass surfaces* calculation type in Window 1.1 *General Data*. You cannot select a load case now, because it does not contain any load data. This is indicated by an asterisk (\*) (see Chapter 3.1.1).

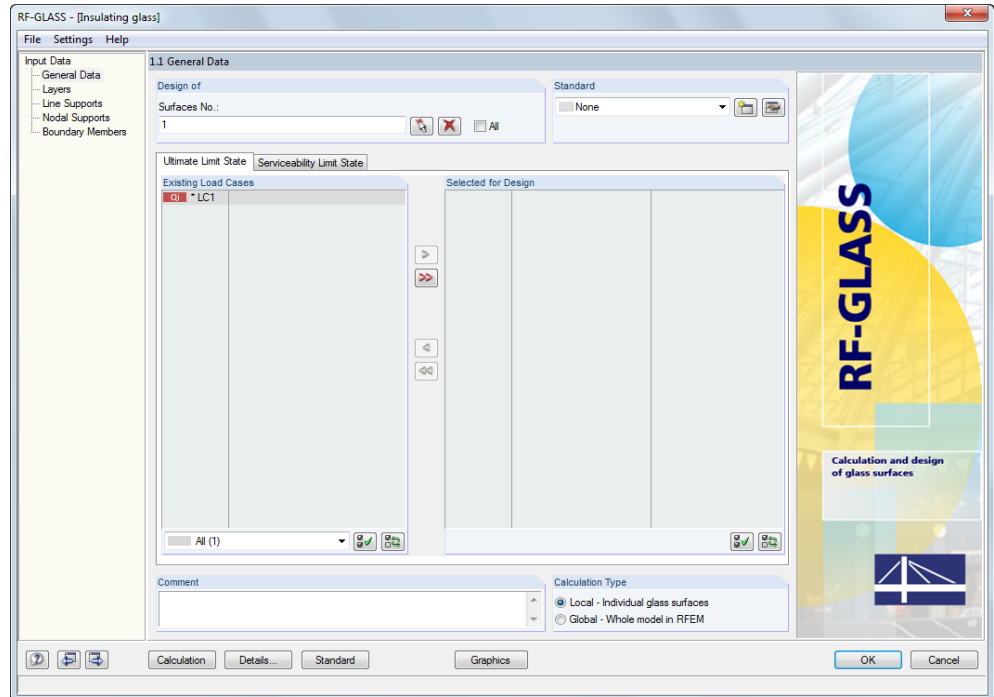

Figure 8.12: Window 1.1 *General Data*

Therefore, you have to go to the 1.2 *Layers* window to define an insulating glass with a gas layer first. Then, you can return to Window 1.1 to select a load case.

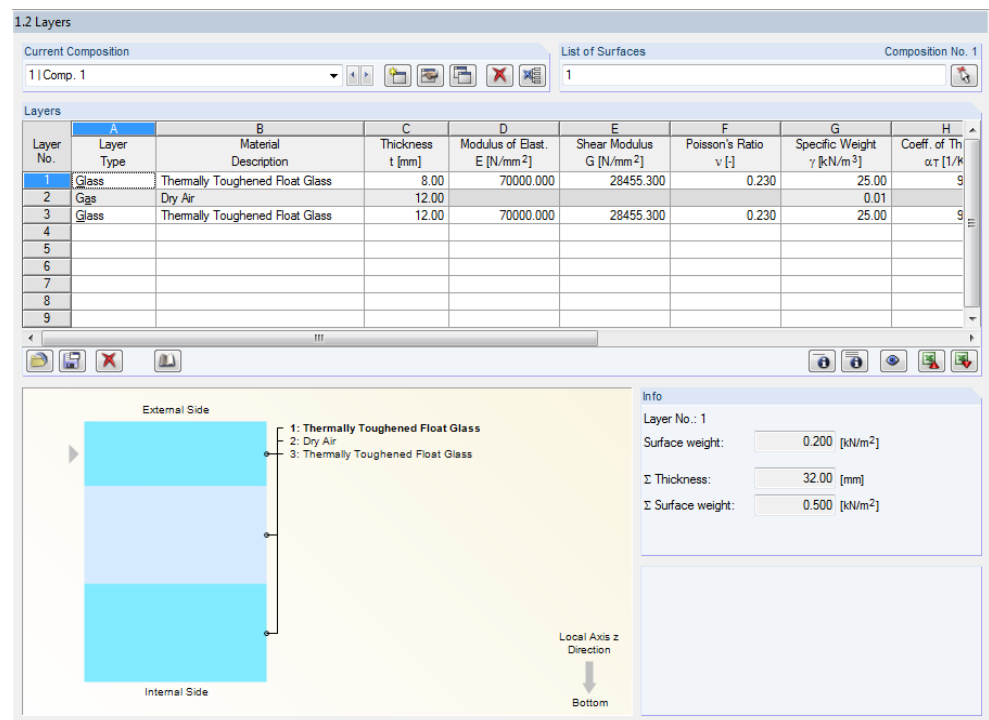

Figure 8.13: Window 1.2 *Layers*

Because you are interested only in the deformation of the model right now, select LC1 only in the *Serviceability Limit State* tab of the 1.1 *General Data* window.

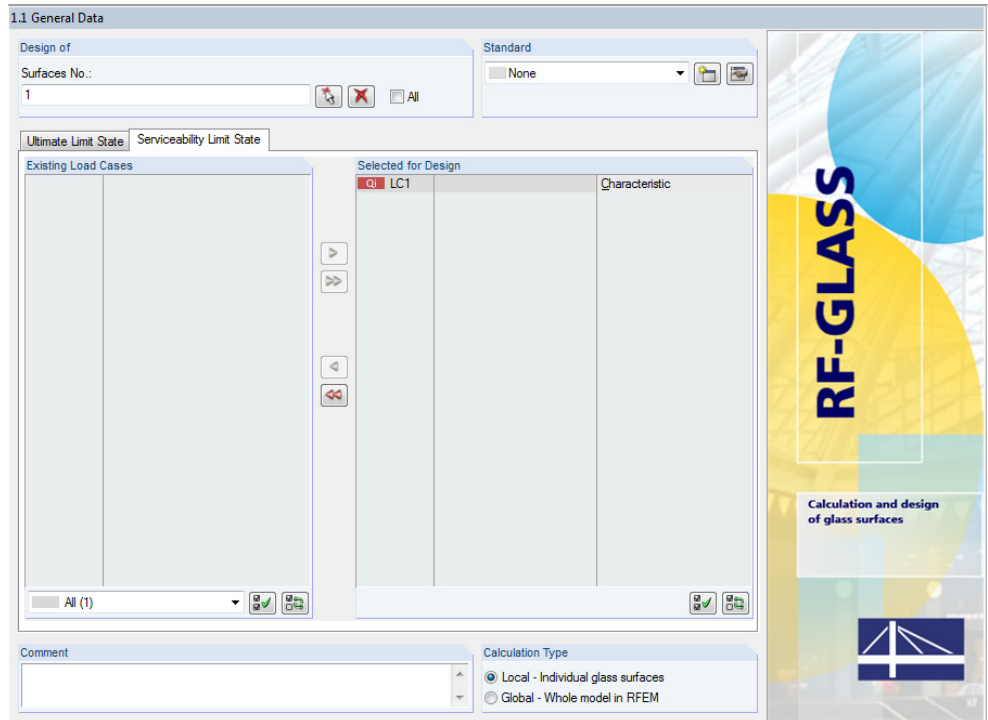

Figure 8.14: Window 1.1 *General Data*, tab *Serviceability Limit State*

In the 1.3 *Line Supports* window, you then select the *Hinged - type 1* support type for the lines 1 to 4.

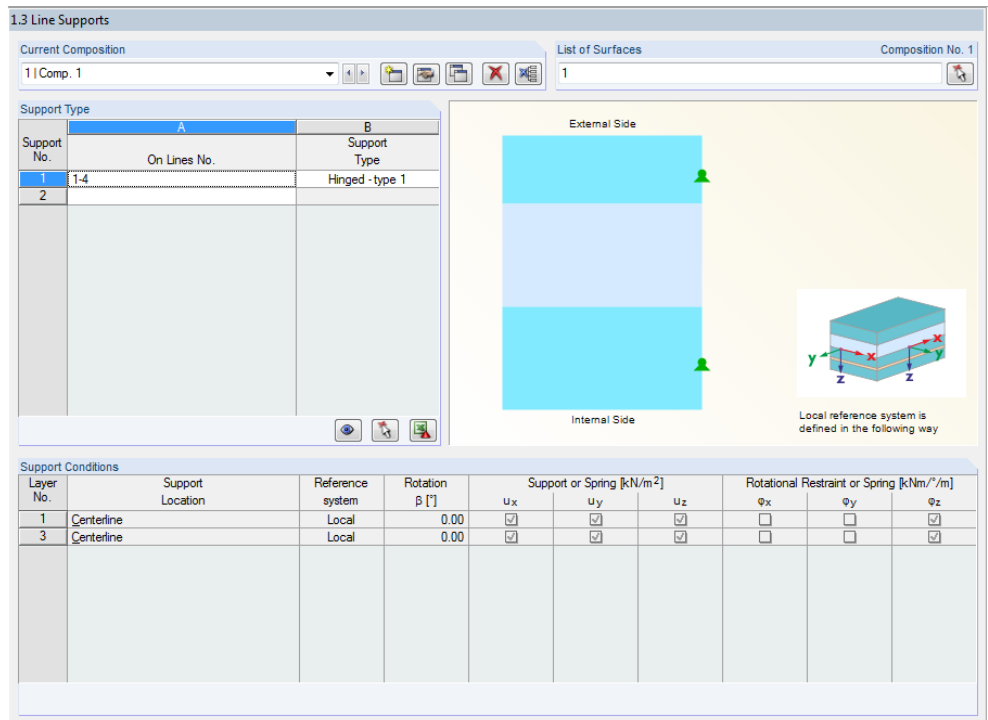
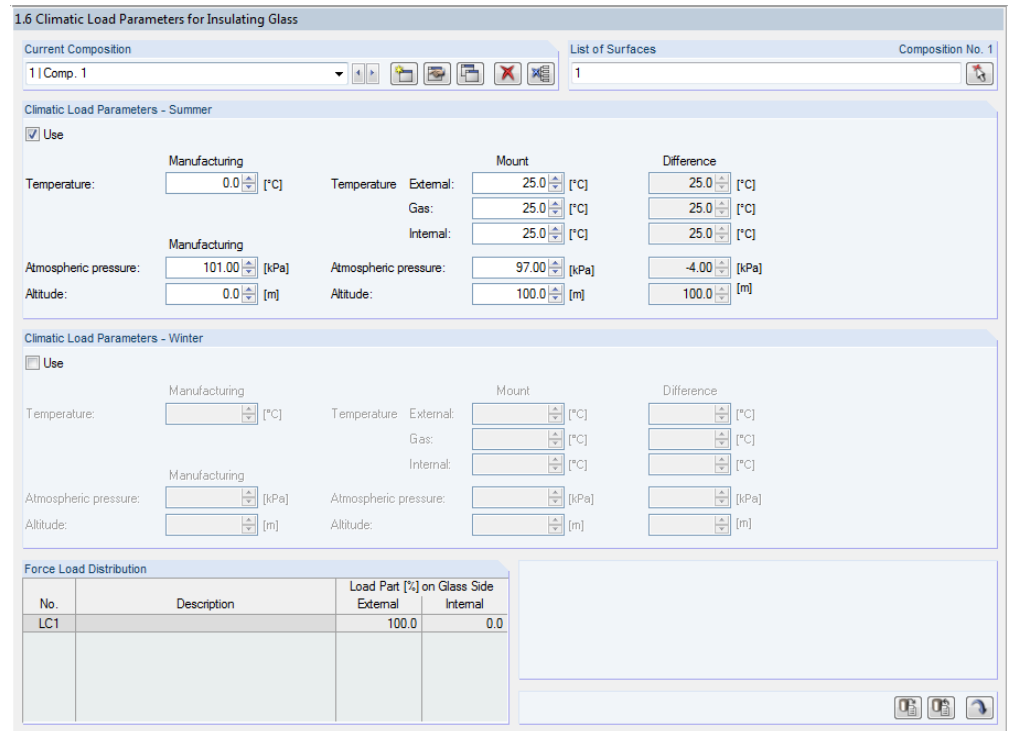

Figure 8.15: Window 1.3 *Line Supports*

Keep the Windows 1.4 *Nodal Supports* and 1.5 *Boundary* empty.



Proceed to Window 1.6 *Climatic Load Parameters for Insulating Glass* to make the following entries:



**1.6 Climatic Load Parameters for Insulating Glass**

Current Composition: 1 | Comp. 1 | List of Surfaces: 1 | Composition No. 1

**Climatic Load Parameters - Summer**

Use

Temperature: Manufacturing: 0.0 [°C] | External: 25.0 [°C] | Gas: 25.0 [°C] | Internal: 25.0 [°C] | Difference: 25.0 [°C]

Atmospheric pressure: Manufacturing: 101.00 [kPa] | External: 97.00 [kPa] | Difference: -4.00 [kPa]

Altitude: Manufacturing: 0.0 [m] | External: 100.0 [m] | Difference: 100.0 [m]

**Climatic Load Parameters - Winter**

Use

Temperature: Manufacturing: [ ] [°C] | External: [ ] [°C] | Gas: [ ] [°C] | Internal: [ ] [°C] | Difference: [ ] [°C]

Atmospheric pressure: Manufacturing: [ ] [kPa] | External: [ ] [kPa] | Difference: [ ] [kPa]

Altitude: Manufacturing: [ ] [m] | External: [ ] [m] | Difference: [ ] [m]

**Force Load Distribution**

No.	Description	Load Part [%] on Glass Side	
		External	Internal
LC1		100.0	0.0

Figure 8.16: Window 1.6 *Climatic Load Parameters for Insulating Glass*

In the 1.8 *Serviceability Data* window, you add surface No. 1 to the *List of Surfaces*. Because the *Maximum border line* reference length type is selected, the *Reference Length L* is specified automatically.

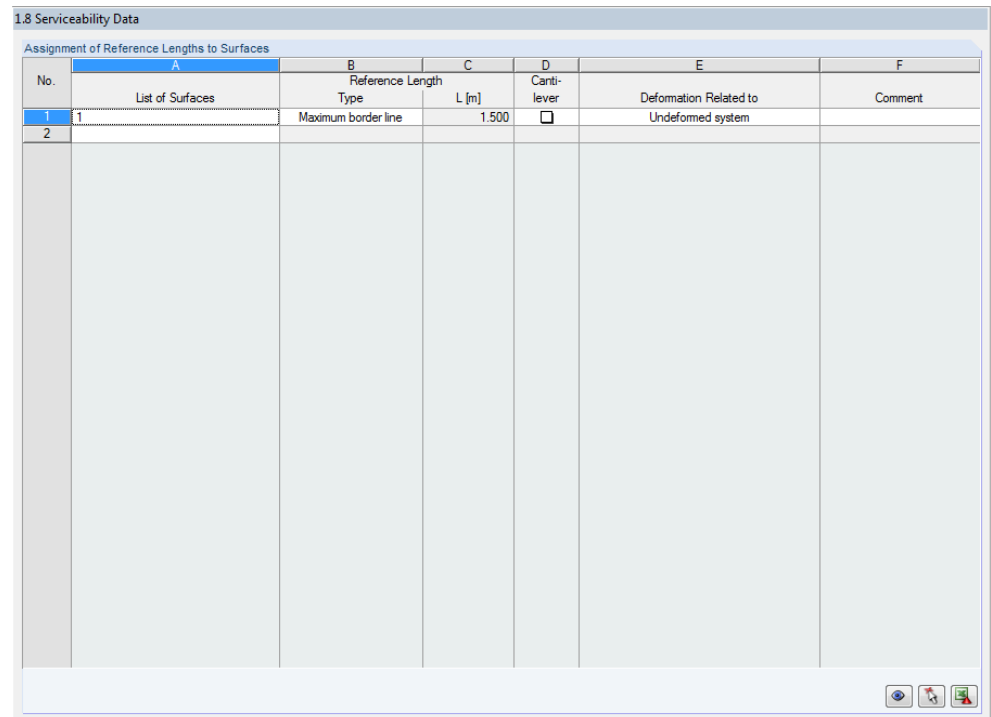

**1.8 Serviceability Data**

Assignment of Reference Lengths to Surfaces

No.	List of Surfaces	Reference Length		Canti-lever	Deformation Related to	Comment
		Type	L [m]			
1	1	Maximum border line	1.500	<input type="checkbox"/>	Undeformed system	
2						

Figure 8.17: Window 1.8 *Serviceability Data*

Finally, check the settings in the *Details of Composition* dialog box.

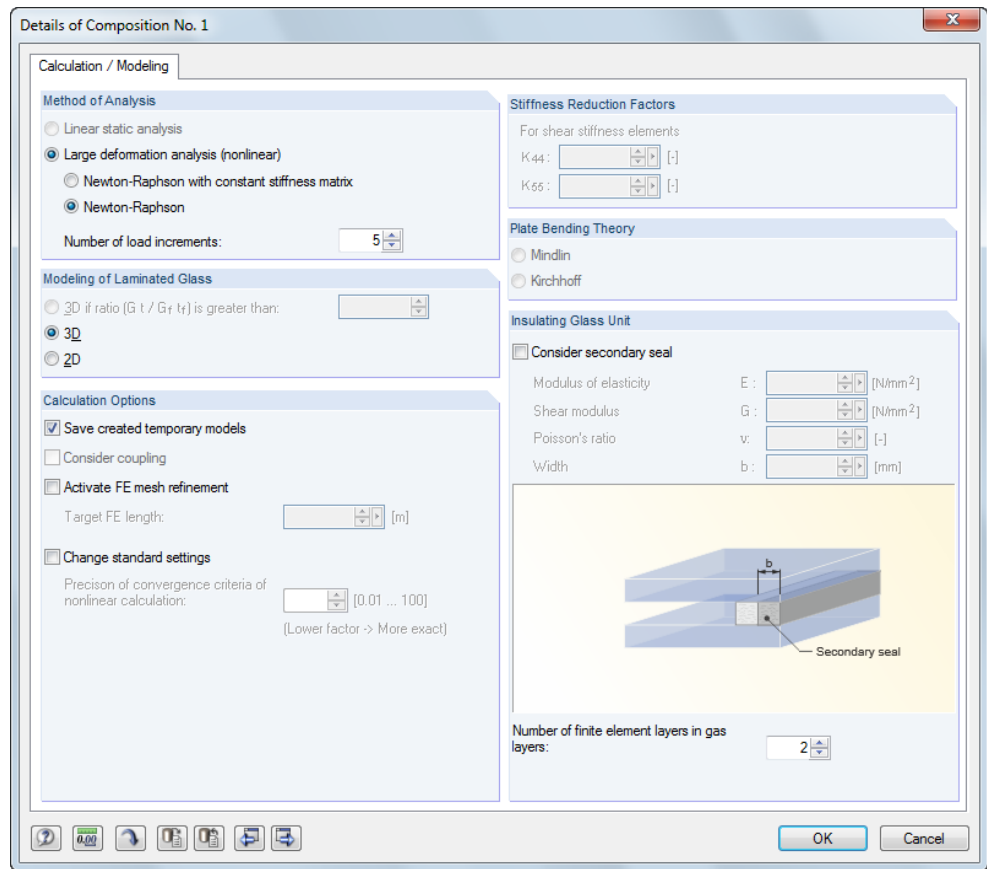

Figure 8.18: Dialog box *Details of Composition*, tab *Calculation / Modeling*

Calculation

Start the [Calculation]. You can notice that due to insulating glass, the calculation proceeds in 3D, thus analyzing individual layers as solids.

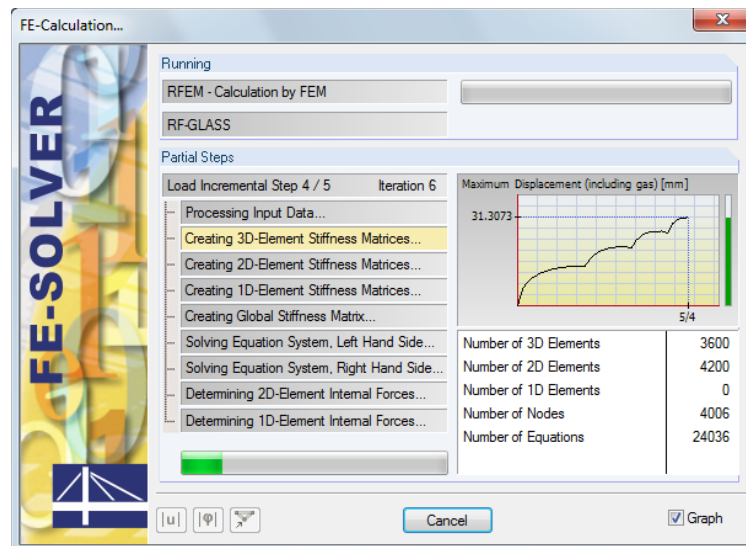

Figure 8.19: Calculation

During the calculation, the *FE-Calculation* dialog box shows the maximum displacement, including the displacement in gas elements. As the displacements are considerable (see figure), the large deformation analysis is always used for insulating glass. This analysis considers the model geometry correctly.

After the calculation, the 3.1 *Max Displacements* shows the displacements of the glass panes.

3.1 Max Displacements										
Surface No.	Point No.	Point Coordinates [m]			Load-ing	Type of Comb.	Packet No.	Displacements [mm]		Ratio $u_z$ [%]
		X	Y	Z				$u_z$	Limit $u_z$	
1	326	0.500	0.750	0.000	LC1: Summer	CH	1	-2.803	15.000	0.19
	326	0.500	0.750	0.000			2	0.980	15.000	0.07
Maximum Displacement / Maximum Displacement Ratio										
1	326	0.500	0.750	0.000	LC1: Summer	CH	1	-2.803	15.000	0.19
	326	0.500	0.750	0.000	LC1: Summer	CH	1	-2.803	15.000	0.19

Figure 8.20: Window 3.1 *Max Displacements*

### 8.2.2 Check of Calculation

The check calculation of this example is carried out in RFEM. Because the calculation of insulating glass proceeds in 3D, you must adjust the RFEM model to the modifications in RF-GLASS. To this end, you selected the *Save created temporary models* check box in the *Details of Composition* dialog box (see Figure 8.18).

Open the generated model in RFEM (it can be found in the same project folder as the original file). Remove the gas solid in this model. Then, assign a surface load  $p$  to the solids of the glass panes. The surface load can be calculated from the thermal state equation for ideal gases:

$$\frac{pV}{T} = \text{const.} \tag{8.5}$$

$$\frac{p_p V_{01}}{T_p} = \frac{p_1 V_1}{T_1} = \frac{p_1 [V_{01} + C_v (p_1 - p_{\text{out}})]}{T_1} \tag{8.6}$$

where  $C_v$ : is the ductility of glass plates defined by the relation

$$C_v(p) = \frac{V(p)}{p} \text{ m}^3/\text{Pa} \tag{8.7}$$

where  $V(p)$ : is the volume between the undeformed and deformed position of a given glass layer due to the pressure  $p$ . The ductility value depends on the instantaneous pressure value.

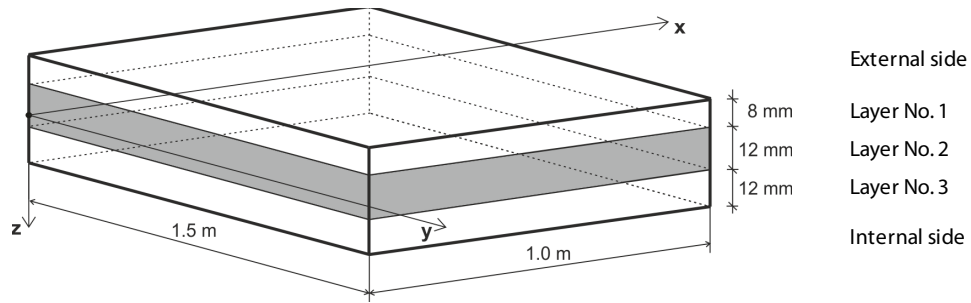

Figure 8.21: Layer composition

The initial gas volume in this example is:

$$V_{01} = a \cdot b \cdot t_2 = 1.0 \cdot 1.5 \cdot 0.012 = 0.018 \text{ m}^3$$

The external gas pressure during at mount is determined as follows:

$$p_{\text{out}} = p_{\text{out,met}} - c_2 \cdot H_2 = p_{p,\text{met}} + \Delta p_{\text{met}} - c_2 \cdot H_2 = p_p + \Delta p_{\text{met}} - c_2 \Delta H \quad (8.8)$$

By substitution, you get:

$$\frac{p_p V_{01} T_1}{T_p} = p_1 \left[ V_{01} + C_v (p_1 - p_p - \Delta p_{\text{met}} + c_2 \Delta H) \right]$$

$$C_v p_1^2 + \left[ V_{01} - C_v (p_p + \Delta p_{\text{met}} - c_2 \Delta H) \right] p_1 - \frac{p_p V_{01} T_1}{T_p} = 0$$

The internal gas pressure at mount is then

$$p_1 = \frac{C_v (p_p + \Delta p_{\text{met}} - c_2 \cdot \Delta H) - V_{01} + \sqrt{\left[ V_{01} - C_v (p_p + \Delta p_{\text{met}} - c_2 \cdot \Delta H) \right]^2 + 4 C_v \frac{p_p V_{01} T_1}{T_p}}}{2 C_v}$$

$$p_p = p_{p,\text{met}} - c_2 \cdot H_1 = 101000 - 12 \cdot 0 = 101000 \text{ Pa}$$

$$\Delta p_{\text{met}} = p_{\text{out,met}} - p_{p,\text{met}} = 97000 - 101000 = -4000 \text{ Pa}$$

$$p_{\text{out}} = p_p + \Delta p_{\text{met}} - c_2 \cdot \Delta H = 101000 - 4000 - 12 \cdot (100 - 0) = 95800 \text{ Pa}$$

The factor  $C_v$  depends on the support type, dimensions, and stiffness of the glass panes. It is calculated by using the following relations:

$$C_v = C_{v1} + C_{v2} \quad (8.9)$$

$$C_{v1}(p) = \frac{V_1}{p} = \frac{1}{p} \int_0^a \int_0^b w_1(x, y) dx dy \quad (8.10)$$

$$C_{v2}(p) = \frac{V_2}{p} = \frac{1}{p} \int_0^a \int_0^b w_2(x, y) dx dy \quad (8.11)$$

where  $C_{v1}$ : is the ductility of layer 1

$C_{v2}$ : is the ductility of layer 3

Because this factor depends on the pressure  $p = p_1 - p_{\text{out}}$ , the calculation is iterative.

**1. Iteration step**

For  $p_1 = 100800$  Pa, you obtain

$$p = p_1 - p_{\text{out}} = 100800 - 95800 = 5000 \text{ Pa}$$

In a nonlinear analysis with an FE mesh element length of 50 mm and a loading of  $p = 5000$  Pa, RFEM determines the maximum deflections

$$w_1 = -6.132 \text{ mm and } w_2 = 3.207 \text{ mm.}$$

By using the RF-IMP module, you obtain the deformations of individual points in the model. Then, you can calculate the volume between the deformed surface and the surface before the deformation, that is,  $V_1 = 4.058 \cdot 10^{-3} \text{ m}^3$  and  $V_2 = 2.047 \cdot 10^{-3} \text{ m}^3$ .

$$C_{v1}(p) = \frac{V_1}{p} = \frac{4.058 \cdot 10^{-3}}{5000} = 8.116 \cdot 10^{-7} \text{ m}^3/\text{Pa}$$

$$C_{v2}(p) = \frac{V_2}{p} = \frac{2.047 \cdot 10^{-3}}{5000} = 4.094 \cdot 10^{-7} \text{ m}^3/\text{Pa}$$

$$C_v = C_{v1} + C_{v2} = 8.116 \cdot 10^{-7} + 4.094 \cdot 10^{-7} = 1.221 \cdot 10^{-6} \text{ m}^3/\text{Pa}$$

$$p_1 = \frac{C_v(p_p + \Delta p_{\text{met}} - c_2 \cdot \Delta H) - V_{01} + \sqrt{\left[ V_{01} - C_v(p_p + \Delta p_{\text{met}} - c_2 \cdot \Delta H) \right]^2 + 4C_v \frac{p_p V_{01} T_1}{T_p}}}{2C_v}$$

Recalculate the root from the previous formula:

$$\begin{aligned} & \sqrt{\left[ V_{01} - C_v(p_p + \Delta p_{\text{met}} - c_2 \cdot \Delta H) \right]^2 + 4C_v \frac{p_p V_{01} T_1}{T_p}} = \\ & = \sqrt{\left[ 0.018 - 1.221 \cdot 10^{-6} \cdot 95800 \right]^2 + 4 \cdot 1.221 \cdot 10^{-6} \frac{101000 \cdot 0.018 \cdot 298.15}{273.15}} = 0.1396 \text{ m}^3 \end{aligned}$$

The gas pressure is then equal to:

$$\begin{aligned} p_1 &= \frac{C_v(p_p + \Delta p_{\text{met}} - c_2 \cdot \Delta H) - V_{01} + \sqrt{\left[ V_{01} - C_v(p_p + \Delta p_{\text{met}} - c_2 \cdot \Delta H) \right]^2 + 4C_v \frac{p_p V_{01} T_1}{T_p}}}{2C_v} = \\ &= \frac{1.221 \cdot 10^{-6} \cdot 95800 - 0.018 + 0.1396}{2 \cdot 1.221 \cdot 10^{-6}} = 97694 \text{ Pa} \end{aligned}$$

**2. Iteration step**

For  $p_1 = 97694$  Pa, you obtain

$$p = p_1 - p_{\text{out}} = 97694 - 95800 = 1894 \text{ Pa}$$

With this loading of  $p = 1894$  Pa, RFEM determines the maximum deflections

$$w_1 = -3.497 \text{ mm and } w_2 = 1.323 \text{ mm.}$$

Redetermine the deformations of the points with RF-IMP. With  $V_1 = 2.253 \cdot 10^{-3} \text{ m}^3$  and  $V_2 = 0.840 \cdot 10^{-3} \text{ m}^3$ , you can determine the volumes of the deformations.

$$C_{v1}(p) = \frac{V_1}{p} = \frac{2.253 \cdot 10^{-3}}{1894} = 1.190 \cdot 10^{-6} \text{ m}^3/\text{Pa}$$

$$C_{v2}(p) = \frac{V_2}{p} = \frac{0.840 \cdot 10^{-3}}{1894} = 4.435 \cdot 10^{-7} \text{ m}^3/\text{Pa}$$

$$C_v = C_{v1} + C_{v2} = 1.190 \cdot 10^{-6} + 4.435 \cdot 10^{-7} = 1.633 \cdot 10^{-6} \text{ m}^3/\text{Pa}$$

$$p_1 = \frac{C_v(p_p + \Delta p_{\text{met}} - c_2 \cdot \Delta H) - V_{01} + \sqrt{\left[ V_{01} - C_v(p_p + \Delta p_{\text{met}} - c_2 \cdot \Delta H) \right]^2 + 4C_v \frac{p_p V_{01} T_1}{T_p}}}{2C_v}$$

Recalculate the root from the previous formula:

$$\begin{aligned} & \sqrt{\left[ V_{01} - C_v(p_p + \Delta p_{\text{met}} - c_2 \cdot \Delta H) \right]^2 + 4C_v \frac{p_p V_{01} T_1}{T_p}} = \\ & = \sqrt{\left[ 0.018 - 1.633 \cdot 10^{-6} \cdot 95800 \right]^2 + 4 \cdot 1.633 \cdot 10^{-6} \frac{101000 \cdot 0.018 \cdot 298.15}{273.15}} = 0.1792 \text{ m}^3 \end{aligned}$$

The gas pressure is then equal to:

$$\begin{aligned} p_1 &= \frac{C_v(p_p + \Delta p_{\text{met}} - c_2 \cdot \Delta H) - V_{01} + \sqrt{\left[ V_{01} - C_v(p_p + \Delta p_{\text{met}} - c_2 \cdot \Delta H) \right]^2 + 4C_v \frac{p_p V_{01} T_1}{T_p}}}{2C_v} = \\ &= \frac{1.633 \cdot 10^{-6} \cdot 95800 - 0.018 + 0.1792}{2 \cdot 1.633 \cdot 10^{-6}} = 97270 \text{ Pa} \end{aligned}$$

### 3. Iteration step

The procedure of the next steps is the same. Therefore, only the most important values are quoted.

$$p = p_1 - p_{\text{out}} = 97270 - 95800 = 1470 \text{ Pa}$$

$$w_1 = -2.920 \text{ mm}, w_2 = 1.034 \text{ mm}$$

$$V_1 = 1.873 \cdot 10^{-3} \text{ m}^3, V_2 = 0.656 \cdot 10^{-3} \text{ m}^3$$

$$C_v = C_{v1} + C_{v2} = 1.274 \cdot 10^{-6} + 4.464 \cdot 10^{-7} = 1.720 \cdot 10^{-6} \text{ m}^3/\text{Pa}$$

$$p_1 = 97204 \text{ Pa}$$

### 4. Iteration step

$$p = p_1 - p_{\text{out}} = 97204 - 95800 = 1404 \text{ Pa}$$

$$w_1 = -2.821 \text{ mm}, w_2 = 0.988 \text{ mm}$$

$$V_1 = 1.808 \cdot 10^{-3} \text{ m}^3, V_2 = 0.627 \cdot 10^{-3} \text{ m}^3$$

$$C_v = C_{v1} + C_{v2} = 1.288 \cdot 10^{-6} + 4.468 \cdot 10^{-7} = 1.735 \cdot 10^{-6} \text{ m}^3/\text{Pa}$$

$$p_1 = 97193 \text{ Pa}$$

**5. Iteration step**

$$p = p_1 - p_{\text{out}} = 97193 - 95800 = 1393 \text{ Pa}$$

$$w_1 = -2.805 \text{ mm}, w_2 = 0.981 \text{ mm}$$

$$V_1 = 1.800 \cdot 10^{-3} \text{ m}^3, V_2 = 0.623 \cdot 10^{-3} \text{ m}^3$$

$$C_v = C_{v1} + C_{v2} = 1.290 \cdot 10^{-6} + 4.469 \cdot 10^{-7} = 1.737 \cdot 10^{-6} \text{ m}^3/\text{Pa}$$

$$p_1 = 97192 \text{ Pa}$$

**6. Iteration step**

$$p = p_1 - p_{\text{out}} = 97192 - 95800 = 1392 \text{ Pa}$$

$$w_1 = -2.803 \text{ mm}, w_2 = 0.980 \text{ mm}$$

$$V_1 = 1.796 \cdot 10^{-3} \text{ m}^3, V_2 = 0.622 \cdot 10^{-3} \text{ m}^3$$

$$C_v = C_{v1} + C_{v2} = 1.290 \cdot 10^{-6} + 4.469 \cdot 10^{-7} = 1.737 \cdot 10^{-6} \text{ m}^3/\text{Pa}$$

$$p_1 = 97192 \text{ Pa}$$

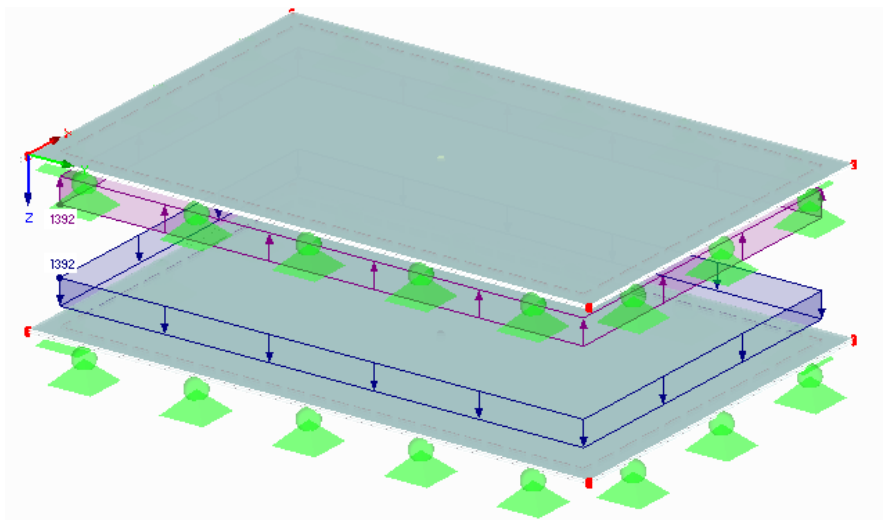

Figure 8.22: RFEM model

**7. Iteration step**

$$p = p_1 - p_{\text{out}} = 97192 - 95800 = 1392 \text{ Pa}$$

$$w_1 = -2.802 \text{ mm}, w_2 = 0.980 \text{ mm}$$

$$V_1 = 1.796 \cdot 10^{-3} \text{ m}^3, V_2 = 0.622 \cdot 10^{-3} \text{ m}^3$$

$$C_v = C_{v1} + C_{v2} = 1.290 \cdot 10^{-6} + 4.469 \cdot 10^{-7} = 1.737 \cdot 10^{-6} \text{ m}^3/\text{Pa}$$

$$p_1 = 97191 \text{ Pa}$$

**8. Iteration step**

$$p = p_1 - p_{\text{out}} = 97191 - 95800 = 1391 \text{ Pa}$$

$$w_1 = -2.802 \text{ mm}, w_2 = 0.980 \text{ mm}$$

$$V_1 = 1.796 \cdot 10^{-3} \text{ m}^3, V_2 = 0.622 \cdot 10^{-3} \text{ m}^3$$

$$C_v = C_{v1} + C_{v2} = 1.290 \cdot 10^{-6} + 4.469 \cdot 10^{-7} = 1.737 \cdot 10^{-6} \text{ m}^3/\text{Pa}$$

$$p_1 = 97191 \text{ Pa}$$

Because the results are identical in the seventh and eighth iteration steps, the iteration process terminates. Therefore, you obtain the maximum deflections

$$w_1 = -2.802 \text{ mm}, w_2 = 0.980 \text{ mm}.$$

The result values in RF-GLASS are  $w_1 = -2.803 \text{ mm}$  and  $w_2 = 0.980 \text{ mm}$ , thus confirming the results.



### 8.3 Insulating Glass According to TRLV, Annex A

Consider the example presented in Chapter 8.2 according to TRLV, Annex A (or DIN 18008-2: 2010-12, Annex A).

For this, the model has to satisfy the following conditions:

- Rectangular surface without opening
- Exactly one gas layer
- Line support of the type *Hinged - type 7* on all boundary lines
- -Loading only by surface load

The calculation is carried out according to Kirchhoff's bending theory and the linear static analysis ([1], [2], [5]).

Glass pane dimension in x-axis direction		$a = 1.0 \text{ m}$	
Glass pane dimension in y-axis direction		$b = 1.5 \text{ m}$	
Thickness of external glass layer		$t_1 = 8 \text{ mm}$	
Thickness of air layer		$t_2 = 12 \text{ mm}$	
Thickness of internal glass layer		$t_3 = 12 \text{ mm}$	
Glass parameters	modulus of elasticity	$E = 70000 \text{ MPa}$	
	shear modulus	$G = 28455 \text{ MPa}$	
	Poisson's ratio	$\nu = 0.23$	
Climatic load	manufac-turing	temperature	$T_p = 0^\circ\text{C}$
		atmospheric pressure	$p_{p,met} = 101 \text{ kPa}$
		sea level	$H_1 = 0 \text{ m}$
	mount	temperature (external = gas = internal)	$T = 25^\circ\text{C}$
		atmospheric pressure	$p_{out,met} = 97 \text{ kPa}$
		sea level	$H_2 = 100 \text{ m}$

Table 8.2: Insulating glass parameters

In contrast to the previous example, the external glass pane is additionally loaded by the external loading  $w_1 = 1 \text{ kN/m}^2$ , that is to be entered in RFEM.

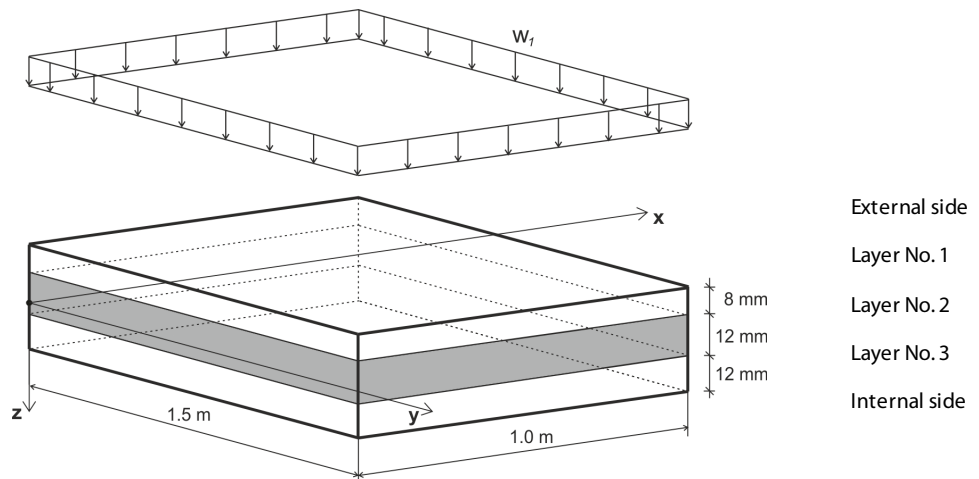

Figure 8.23: Loading scheme

The rate of the external glass pane in the total bending stiffness is:

$$\delta_1 = \frac{t_1^3}{t_1^3 + t_2^3} = \frac{8^3}{8^3 + 12^3} = 0.2286 \quad \text{TRLV, Annex A, Equation A1}$$

The rate of the internal glass pane in the total bending stiffness is:

$$\delta_2 = \frac{t_2^3}{t_1^3 + t_2^3} = \frac{12^3}{8^3 + 12^3} = 0.7714 \quad \text{TRLV, Annex A, Equation A2}$$

The characteristic edge length is then:

$$a^* = 28.9 \cdot \sqrt[4]{\frac{t_3 \cdot t_1^3 \cdot t_2^3}{(t_1^3 + t_2^3) B_v}} \quad \text{TRLV, Annex A, Equation A3}$$

where  $B_v$  is determined from the ratio  $a/b = 1000/1500 = 0.667$

$a/b$	1.0	0.9	0.8	0.7	0.6	0.5	0.4	0.3	0.2	0.1
$B_v$	0.0194	0.0237	0.0288	0.0350	0.0421	0.0501	0.0587	0.0676	0.0767	0.0857

TRLV, Annex A, Table A1

By linear interpolation, you obtain:

$$B_v = 0.0373$$

$$a^* = 28.9 \cdot \sqrt[4]{\frac{t_3 \cdot t_1^3 \cdot t_2^3}{(t_1^3 + t_2^3) B_v}} = 28.9 \cdot \sqrt[4]{\frac{12 \cdot 8^3 \cdot 12^3}{(8^3 + 12^3) 0.0373}} = 546 \text{ mm}$$

The factor  $\varphi$  is determined as:

$$\varphi = \frac{1}{1 + \left(\frac{a}{a^*}\right)^4} = \frac{1}{1 + \left(\frac{1000}{546}\right)^4} = 0.081 \quad \text{TRLV, Annex A, Equation A4}$$

The pressure inside the insulating glass due to climatic changes is:

$$p_0 = c_1 \Delta T - \Delta p_{\text{met}} + c_2 \Delta H = 340 \cdot 25 - (97000 - 101000) + 12 \cdot 100 = 13700 \text{ Pa} = 13.7 \text{ kN/m}^2$$

TRLV, Annex A, Equation A5

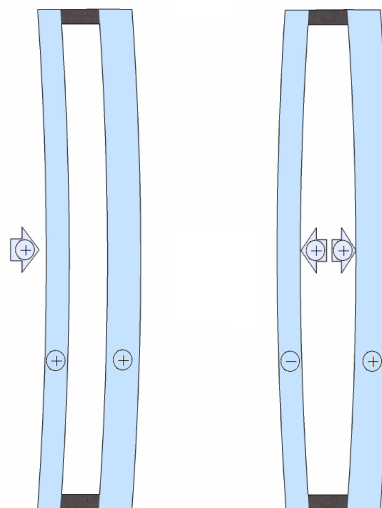

Figure 8.24: Wind load  $w_1$  (left) and load due to climatic changes  $p_0$  (right)

The following table shows the load distribution for the individual glass panes:

Loading on		Load part for	
		External pane	Internal pane
External pane	wind $w_1$	$(\delta_1 + \varphi\delta_2) \cdot w_1$	$(1 - \varphi)\delta_2 \cdot w_1$
	snow $s$	$(\delta_1 + \varphi\delta_2) \cdot s$	$(1 - \varphi)\delta_2 \cdot s$
Internal pane	wind $w_2$	$(1 - \varphi)\delta_1 \cdot w_2$	$(\varphi\delta_1 + \delta_2) \cdot w_2$
Both panes	internal pressure $p_0$	$-\varphi \cdot p_0$	$+\varphi \cdot p_0$

TRLV, Annex A, Table A2

For this example:

Loading on		Load part for	
		External pane	Internal pane
External pane	$w_1$	$(0.2286 + 0.081 \cdot 0.7714) \cdot 1.0 =$ $= 0.29 \text{ kN/m}^2$	$(1 - 0.081) \cdot 0.7714 \cdot 1.0 =$ $= 0.71 \text{ kN/m}^2$
Both panes	$p_0$	$-0.081 \cdot 13.7 = -1.11 \text{ kN/m}^2$	$0.081 \cdot 13.7 = 1.11 \text{ kN/m}^2$

Table 8.3: Load for glass panes

The total loading is therefore:

- External glass pane  $f_1 = 0.29 + (-1.11) = -0.82 \text{ kN/m}^2$
- Internal glass pane  $f_2 = 0.71 + 1.11 = 1.82 \text{ kN/m}^2$

The input in RF-GLASS is done as described in Chapter 8.2. In the 1.1 *General Data* window, select the TRLV standard. In the 1.6 *Climatic Load Parameters* window, select the option *Calculation according to Appendix A*.

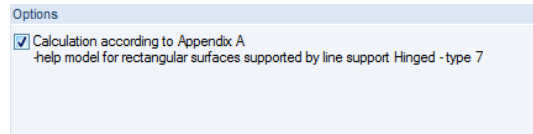

Figure 8.25: Calculation according to TRLV, Annex A

Check in the *Force Load Distribution* section of this window if 100 % of the load acts on the *External glass side*.

In the *Details of Composition* dialog box, select the *Linear static analysis* option and the *Save created temporary models* check box.

The [Calculation] gives maximum deflections of  $w_1 = -2.015 \text{ mm}$ ,  $w_2 = 1.323 \text{ mm}$ .

If we open the generated model in RFEM, we can display and check the loads of the glass surfaces.

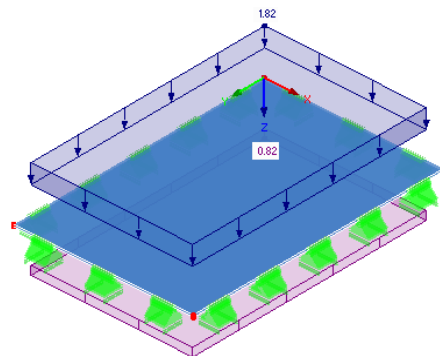

Figure 8.26: RFEM model with loading

## 8.4 Curved Insulating Glass

Consider a fixed curved insulating glass, with a composition displayed in Figure 8.27. The following parameters are used:

Glass pane dimension in x-axis direction $x$ $y$ $z$		$a = 1.0$ m	
Internal radius of curvature		$R = 3.0$ m	
Central angle		$\alpha = 30^\circ$	
Thickness of glass pane 1		$t_1 = 5$ mm	
Thickness of air layer		$t_{SZR} = 12$ mm	
Thickness of glass pane 2		$t_2 = 5$ mm	
Thickness of foil		$t_f = 0.76$ mm	
Thickness of glass pane 3		$t_3 = 5$ mm	
Glass parameters	modulus of elasticity	$E = 70000$ MPa	
	shear modulus	$G = 28455$ MPa	
	Poisson's ratio	$\nu = 0.23$	
Foil parameters	modulus of elasticity	$E = 3$ MPa	
	shear modulus	$G = 1$ MPa	
	Poisson's ratio	$\nu = 0.499$	
Climatic load	manufacturing	temperature	$T_p = 0^\circ\text{C}$
		atmospheric pressure	$p_{p,met} = 101$ kPa
		sea level	$H_1 = 0$ m
	mount	temperature (external = gas = internal)	$T_1 = 25^\circ\text{C}$
		atmospheric pressure	$p_{out,met} = 101$ kPa
		sea level	$H_2 = 0$ m

Table 8.4: Parameters of fixed curved insulating glass

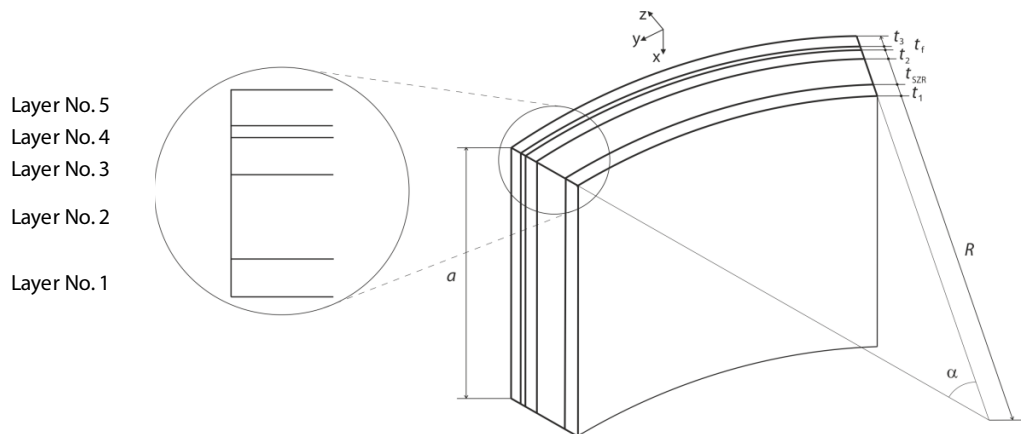

Figure 8.27: Curved glass

The length of the finite elements is 50 mm.

### 8.4.1 Calculation in RF-GLASS



First, we create a *New Model* in RFEM.

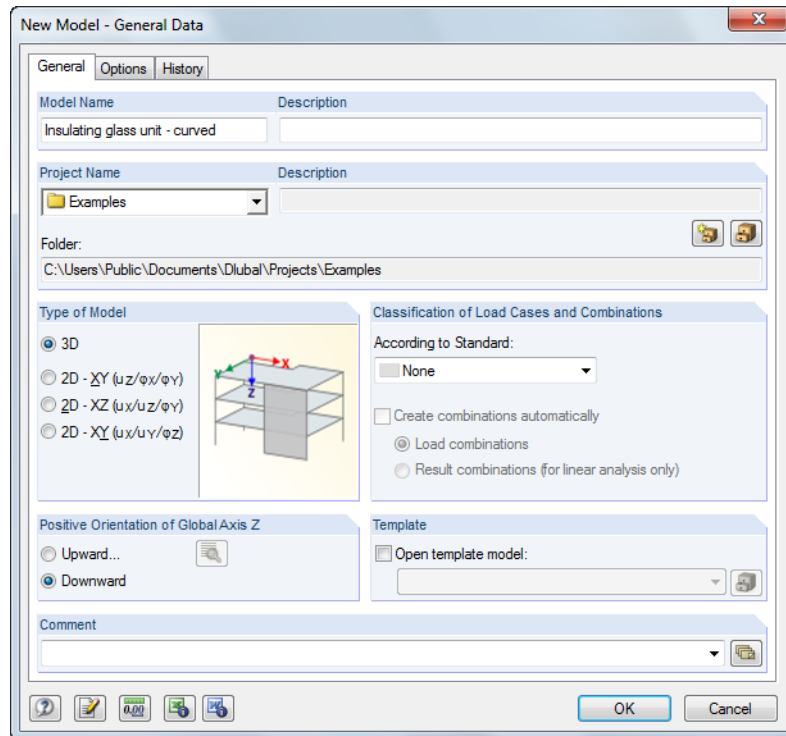

Figure 8.28: Dialog box *New Model - General Data*



After entering the general data, you define an *Arc via Center Node, Edge Node and Angle*. The distance between the center and edge node is 3 m, the included angle is 30°.



Then, open the *Extrude Line into Surface* dialog box. Define the height  $h = 1\text{ m}$  and the offset as  $e = 0\text{ m}$ . Next, check if the surface axis system is oriented as shown in the following figure. If this is not the case, rotate it.

Because you want to carry out the *Local* calculation type in RF-GLASS, the supports are defined directly in the module. Therefore, it is not necessary to define any supports in RFEM.

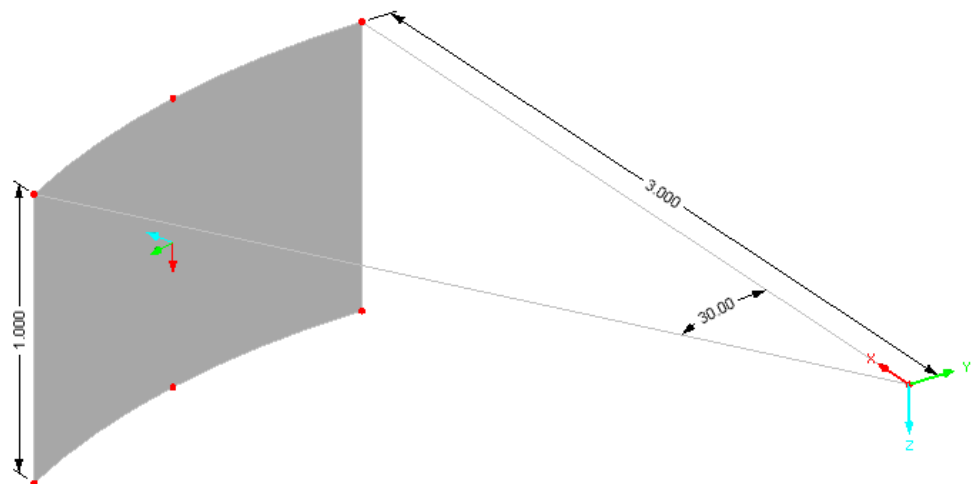

Figure 8.29: Defining arc and extruding line into surface



Although there is no external loading on the model, you have to create a load case to start the calculation in RF-GLASS. The self-weight should **not** be *Active*.

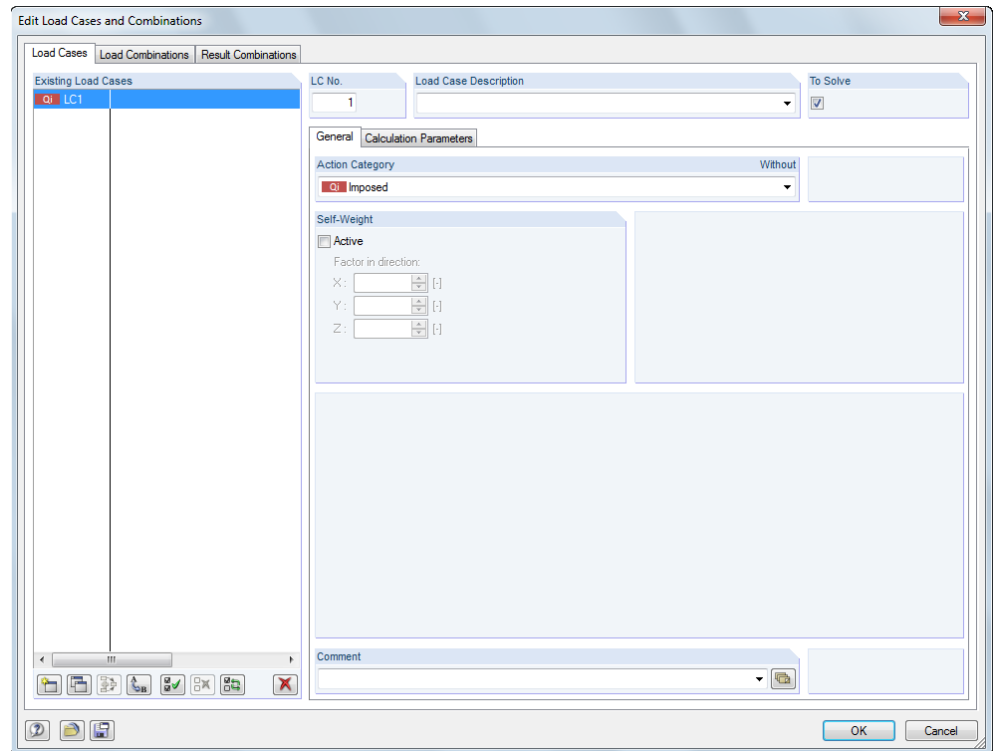

Figure 8.30: Dialog box *Edit Load Cases and Combinations*

In the *FE Mesh Settings* dialog box, you specify **0.05 m** as target length of finite elements.

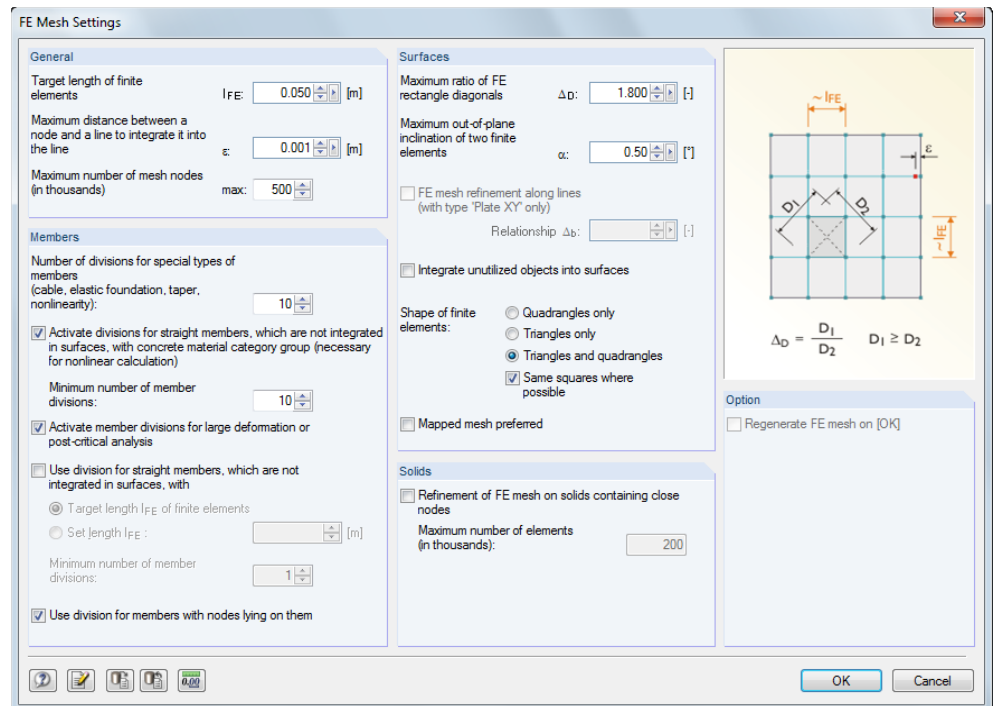

Figure 8.31: Dialog box *FE Mesh Settings*

Now, start the RF-GLASS module.

Because you want to create insulating glass, you should select the *Local – Individual glass surfaces* calculation type in Window 1.1 *General Data*. You cannot select a load case now, because LC1 does not contain any load data. This is indicated by an asterisk (\*) (see Chapter 3.1.1).

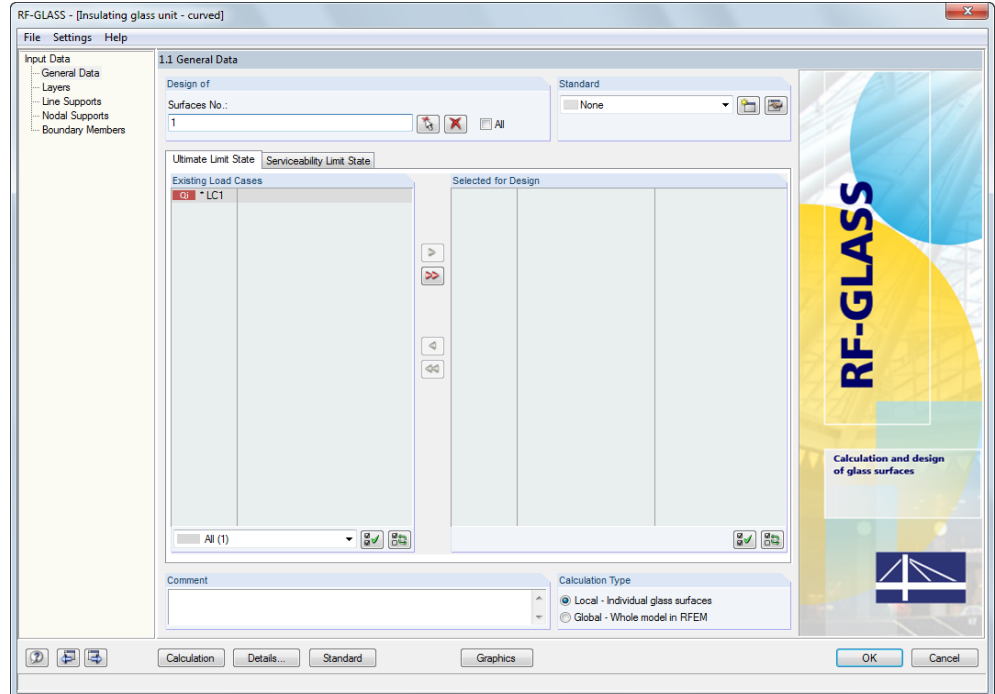

Figure 8.32: Window 1.1 *General Data*

Therefore, go to the 1.2 *Layers* window, where you select an insulating glass with gas layer. Now it is possible to select a load case in Window 1.1.

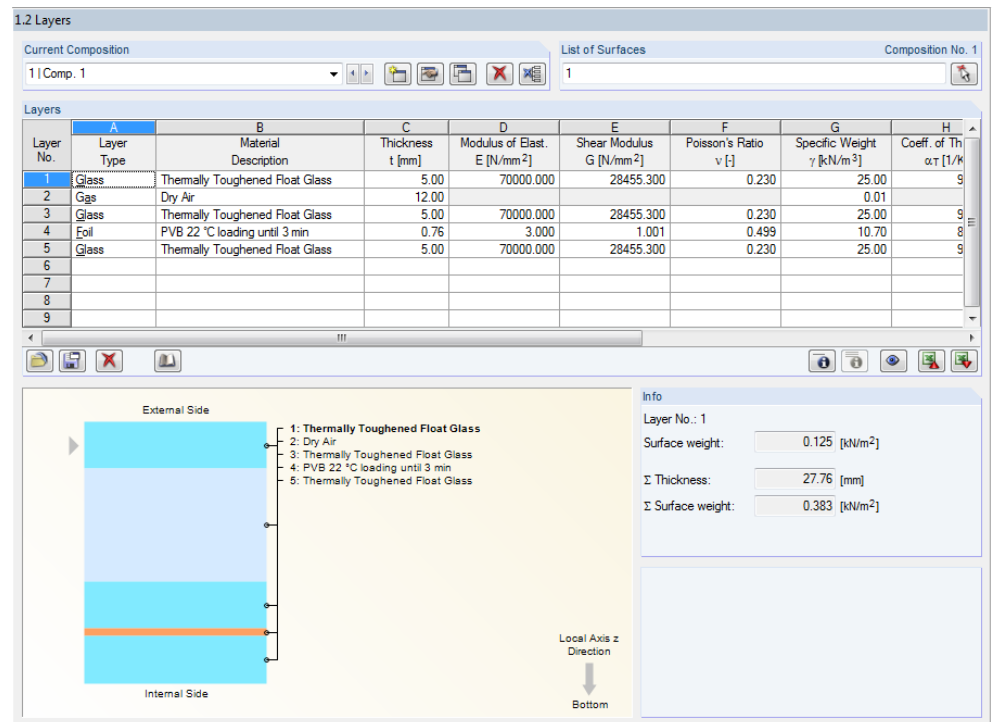

Figure 8.33: Window 1.2 *Layers*

Because you are currently only interested in the deformation of the model, select LC1 only in the *Serviceability Limit State* tab of the 1.1 *General Data* window.

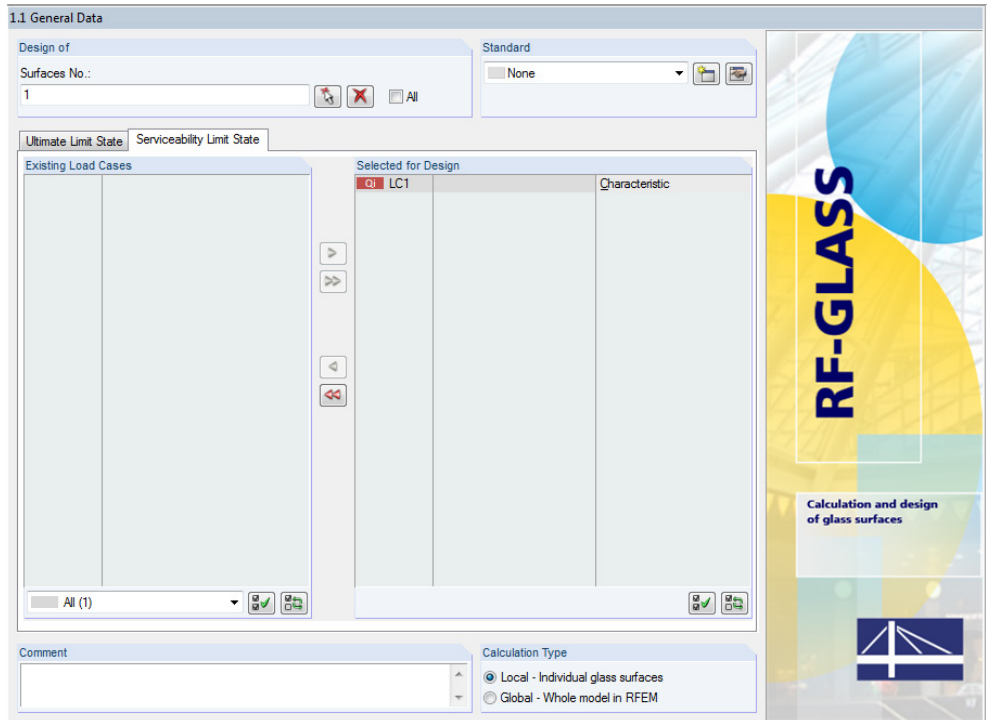

Figure 8.34: Window 1.1 *General Data*, tab *Serviceability Limit State*

In the 1.3 *Line Supports* window, you select the support type *Rigid* for the lines 1 to 4.

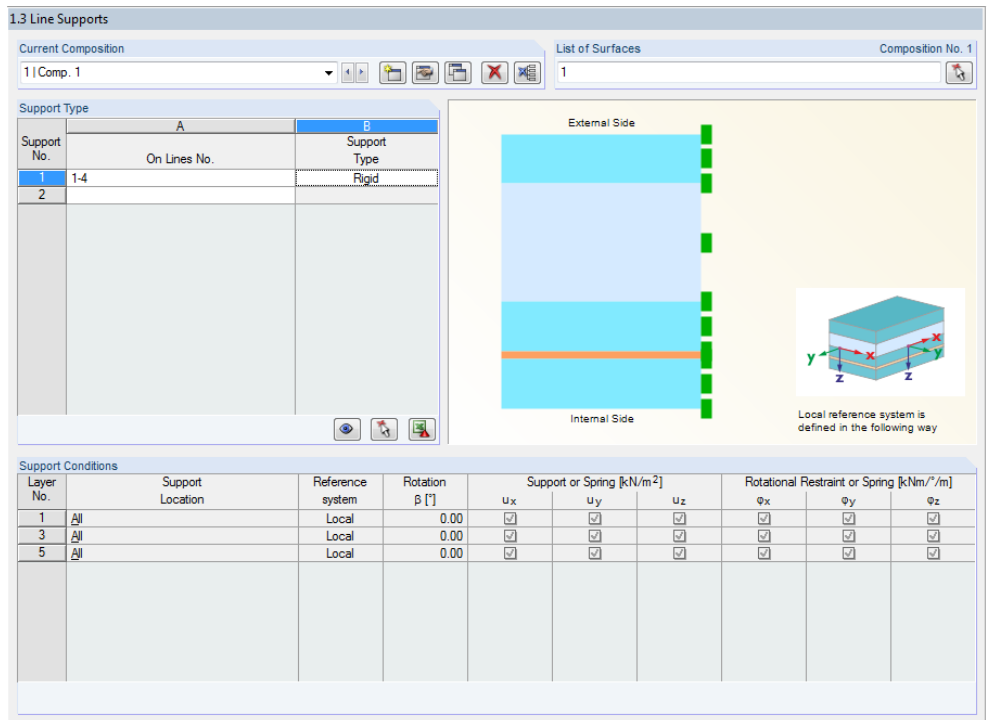
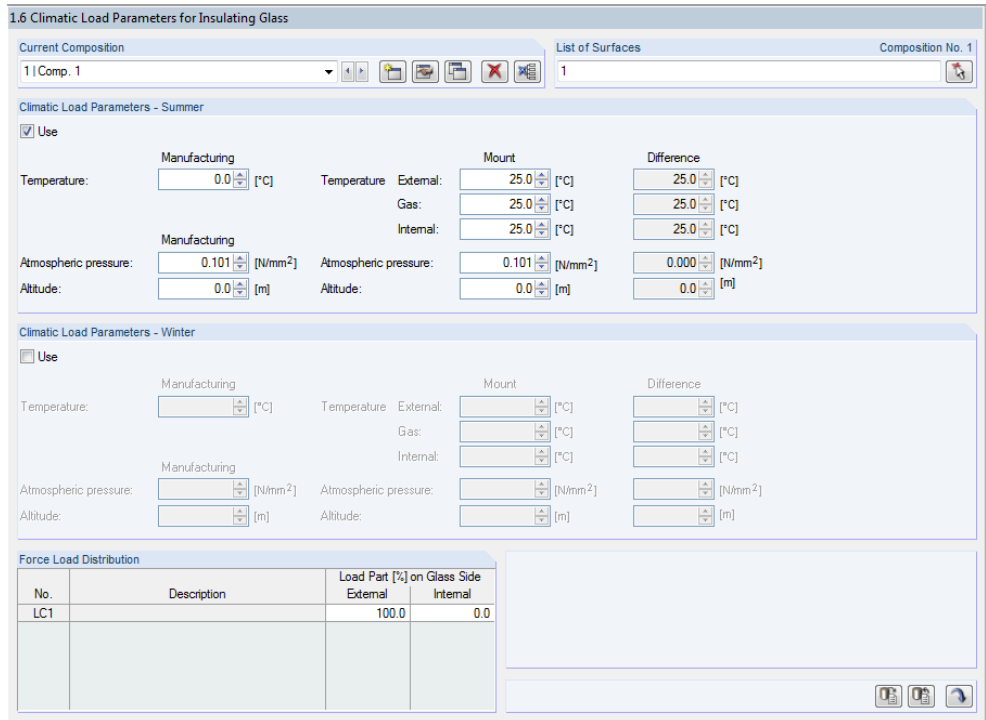

Figure 8.35: Window 1.3 *Line Supports*

Leave Windows 1.4 *Nodal Supports* and 1.5 *Boundary* empty.



Proceed to Window 1.6 *Climatic Load Parameters for Insulating Glass* to make the following entries:



The screenshot shows the '1.6 Climatic Load Parameters for Insulating Glass' window. It is divided into two main sections: 'Climatic Load Parameters - Summer' and 'Climatic Load Parameters - Winter'. The 'Summer' section is active, with a 'Use' checkbox checked. It contains input fields for Manufacturing, Mount, and Difference parameters for Temperature, Atmospheric pressure, and Altitude. The 'Winter' section is inactive, with its 'Use' checkbox unchecked. Below these sections is a 'Force Load Distribution' table.

No.	Description	Load Part [%] on Glass Side	
		External	Internal
LC1		100.0	0.0

Figure 8.36: Window 1.6 *Climatic Load Parameters for Insulating Glass*

In the 1.8 *Serviceability Data* window, you add surface No. 1 to the *List of Surfaces*. Because the *Maximum border line* reference length type is selected, the *Reference Length L* is automatically completed.

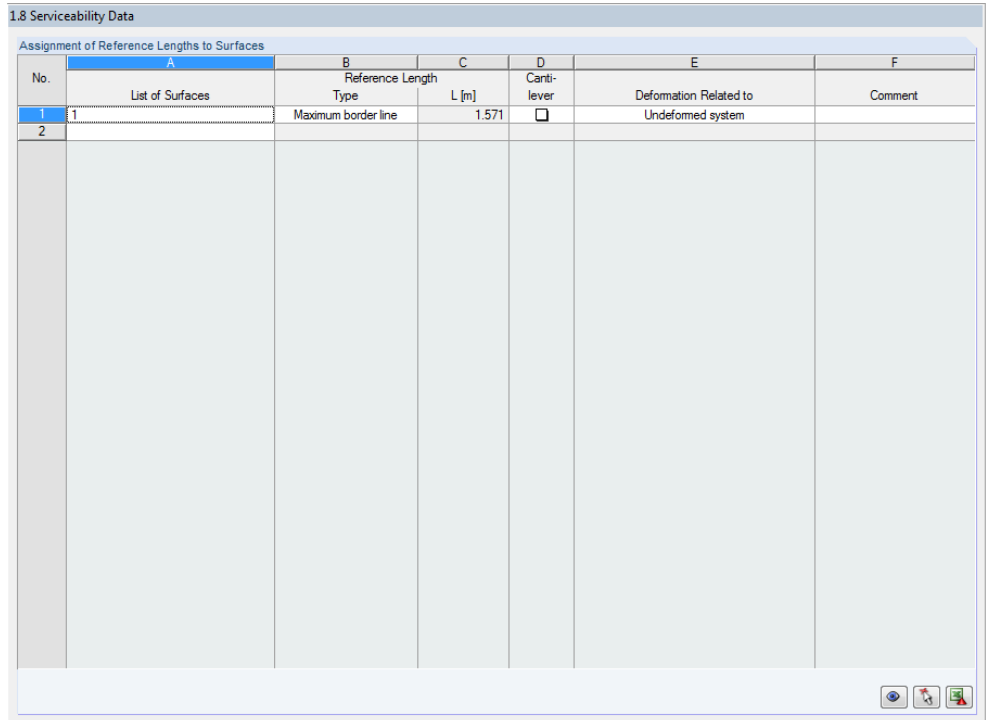

The screenshot shows the '1.8 Serviceability Data' window, titled 'Assignment of Reference Lengths to Surfaces'. It contains a table with columns A through F.

No.	A List of Surfaces	B Reference Length Type	C L [m]	D Cantilever	E Deformation Related to Undeformed system	F Comment
1	1	Maximum border line	1.571	<input type="checkbox"/>		
2						

Figure 8.37: Window 1.8 *Serviceability Data*

Finally, check the settings in the *Details of Composition* dialog box.

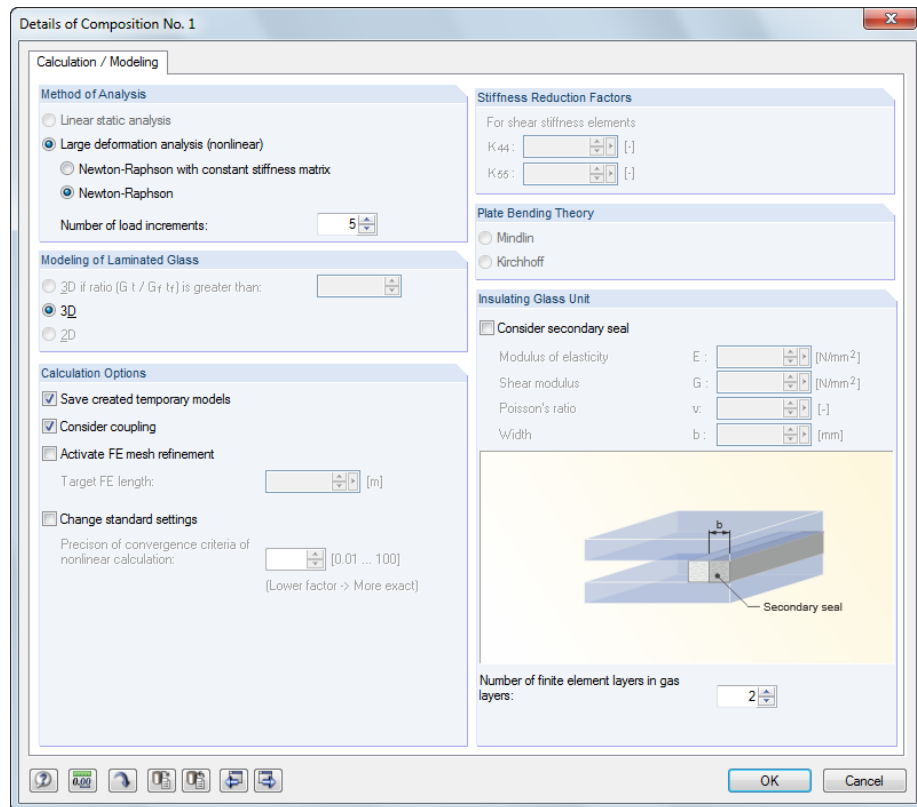

Figure 8.38: Dialog box *Details of Composition*

Calculation

Start the [Calculation]. Because of the insulating glass, the calculation runs in 3D in which all layers are analyzed as solids.

The 3.1 *Max Displacements* window shows the displacements of the glass panes.

3.1 Max Displacements

Surface No.	A		B		C		D		E	F	G	H		I	J
	Point No.	X	Y	Z	Load-ing	Type of Comb.	Packet No.	Displacements [mm]				Limit $u_z$	Ratio $u_z$ [-]		
1	421	2.772	-1.148	0.600	LC1; Summer	CH	1	-0.265	15.708	0.02					
	454	2.772	-1.148	0.650			2	0.123	15.708	0.01					
Maximum Displacement / Maximum Displacement Ratio															
1	421	2.772	-1.148	0.600	LC1; Summer	CH	1	-0.265	15.708	0.02					
	421	2.772	-1.148	0.600	LC1; Summer	CH	1	-0.265	15.708	0.02					

Max ratio: 0.02 ≤ 1

Figure 8.39: Window 3.1 *Max Displacements*

### 8.4.2 Check of Calculation

The check calculation of this example is carried out in RFEM. Because the calculation of insulating glass proceeds in 3D, you must adjust the RFEM model to the modifications in RF-GLASS. To this end, you selected the *Save created temporary models* check box in the *Details of Composition* dialog box (see Figure 8.38).

Open the generated model in RFEM (it can be found in the same project folder as the original file). Remove the gas solid in this model. Then, assign a surface load  $p$  to the solids of the glass panes. The surface load can be calculated from the thermal state equation for ideal gases as follows:

$$\frac{pV}{T} = \text{const.} \quad (8.12)$$

$$\frac{p_p V_{01}}{T_p} = \frac{p_1 V_1}{T_1} = \frac{p_1 [V_{01} + C_v (p_1 - p_{\text{out}})]}{T_1} \quad (8.13)$$

where  $C_v$ : is the ductility of the glass plates, defined as

$$C_v(p) = \frac{V(p)}{p} \quad \text{m}^3/\text{Pa} \quad (8.14)$$

where  $V(p)$ : is the volume between the undeformed and deformed position of a given glass layer due to the pressure  $p$ . The ductility value depends on the instantaneous pressure value.

The initial volume in this example is:

$$V_{01} = a \cdot b \cdot t_2 = 1.0 \cdot 1.5 \cdot 0.012 = 189.153 \cdot 10^{-4} \text{ m}^3$$

The external gas pressure at mount is determined as follows:

$$p_{\text{out}} = p_{\text{out,met}} - c_2 \cdot H_2 = p_{p,\text{met}} + \Delta p_{\text{met}} - c_2 \cdot H_2 = p_p + \Delta p_{\text{met}} - c_2 \Delta H \quad (8.15)$$

By substitution, you obtain:

$$\frac{p_p V_{01} T_1}{T_p} = p_1 [V_{01} + C_v (p_1 - p_p - \Delta p_{\text{met}} + c_2 \Delta H)]$$

$$C_v p_1^2 + [V_{01} - C_v (p_p + \Delta p_{\text{met}} - c_2 \Delta H)] p_1 - \frac{p_p V_{01} T_1}{T_p} = 0$$

The internal gas pressure at mount is then

$$p_1 = \frac{C_v (p_p + \Delta p_{\text{met}} - c_2 \cdot \Delta H) - V_{01} + \sqrt{[V_{01} - C_v (p_p + \Delta p_{\text{met}} - c_2 \cdot \Delta H)]^2 + 4 C_v \frac{p_p V_{01} T_1}{T_p}}}{2 C_v}$$

$$p_p = p_{p,\text{met}} - c_2 \cdot H_1 = 101000 - 12 \cdot 0 = 101000 \text{ Pa}$$

$$\Delta p_{\text{met}} = p_{\text{out,met}} - p_{p,\text{met}} = 101000 - 101000 = 0 \text{ Pa}$$

$$p_{\text{out}} = p_p + \Delta p_{\text{met}} - c_2 \cdot \Delta H = 101000 - 0 - 12 \cdot (100 - 0) = 101000 \text{ Pa}$$

The factor  $C_v$  depends on the support type, dimensions, and stiffness of the glass panes. You can calculate them by using the following formula:

$$C_v = C_{v1} + C_{v2} \quad (8.16)$$

$$C_{v1}(p) = \frac{V_1}{p} = \frac{1}{p} \int_0^a \int_0^b w_1(x, y) dx dy \quad (8.17)$$

$$C_{v2}(p) = \frac{V_2}{p} = \frac{1}{p} \int_0^a \int_0^b w_2(x, y) dx dy \quad (8.18)$$

where  $C_{v1}$ : is the ductility of layer 1

$C_{v2}$ : is the ductility of layer 3

Because this factor depends on the pressure  $p = p_1 - p_{out}$ , the calculation is iterative.

### 1. Iteration step

For  $p_1 = 106000$  Pa, you obtain

$$p = p_1 - p_{out} = 106000 - 10100 = 5000 \text{ Pa}$$

In a nonlinear analysis with an FE mesh element length of 50 mm and a loading of  $p = 5000$  Pa, RFEM determines the maximum deflections

$$w_1 = -0.178 \text{ mm and } w_2 = 0.084 \text{ mm.}$$

By using the RF-IMP module, you obtain the deformations of individual points in the model. Then, you can calculate the volume between the deformed surface and the surface before the deformation, that is,  $V_1 = 14.997 \cdot 10^{-5} \text{ m}^3$  and  $V_2 = 7.478 \cdot 10^{-5} \text{ m}^3$ .

$$C_{v1}(p) = \frac{V_1}{p} = \frac{14.997 \cdot 10^{-5}}{5000} = 2.999 \cdot 10^{-8} \text{ m}^3/\text{Pa}$$

$$C_{v2}(p) = \frac{V_2}{p} = \frac{7.478 \cdot 10^{-5}}{5000} = 1.496 \cdot 10^{-8} \text{ m}^3/\text{Pa}$$

$$C_v = C_{v1} + C_{v2} = 2.999 \cdot 10^{-8} + 1.496 \cdot 10^{-8} = 4.495 \cdot 10^{-8} \text{ m}^3/\text{Pa}$$

$$p_1 = \frac{C_v(p_p + \Delta p_{met} - c_2 \cdot \Delta H) - V_{01} + \sqrt{[V_{01} - C_v(p_p + \Delta p_{met} - c_2 \cdot \Delta H)]^2 + 4C_v \frac{p_p V_{01} T_1}{T_p}}}{2C_v}$$

Recalculate the root from the previous formula:

$$\begin{aligned} & \sqrt{[V_{01} - C_v(p_p + \Delta p_{met} - c_2 \cdot \Delta H)]^2 + 4C_v \frac{p_p V_{01} T_1}{T_p}} = \\ & = \sqrt{[189.153 \cdot 10^{-4} - 4.495 \cdot 10^{-8} \cdot 101000]^2 + 4 \cdot 4.495 \cdot 10^{-8} \frac{101000 \cdot 189.153 \cdot 10^{-4} \cdot 298.15}{273.15}} = \\ & = 0.02412 \text{ m}^3 \end{aligned}$$

The gas pressure is then equal to:

$$\begin{aligned} p_1 & = \frac{C_v(p_p + \Delta p_{met} - c_2 \cdot \Delta H) - V_{01} + \sqrt{[V_{01} - C_v(p_p + \Delta p_{met} - c_2 \cdot \Delta H)]^2 + 4C_v \frac{p_p V_{01} T_1}{T_p}}}{2C_v} = \\ & = \frac{4.495 \cdot 10^{-8} \cdot 101000 - 189.153 \cdot 10^{-4} + 0.02412}{2 \cdot 4.495 \cdot 10^{-8}} = 108351 \text{ Pa} \end{aligned}$$

### 2. Iteration step

For  $p_1 = 108351 \text{ Pa}$ , we obtain

$$p = p_1 - p_{\text{out}} = 108351 - 101000 = 7351 \text{ Pa}$$

With this loading of  $p = 7351 \text{ Pa}$ , RFEM determines the maximum deflections

$$w_1 = -0.265 \text{ mm} \text{ and } w_2 = 0.123 \text{ mm}.$$

The deformations of the points are recalculated with RF-IMP. Then, you can determine the volume of the deformations with  $V_1 = 2.212 \cdot 10^{-4} \text{ m}^3$  and  $V_2 = 1.099 \cdot 10^{-4} \text{ m}^3$ .

$$C_{v1}(p) = \frac{V_1}{p} = \frac{2.212 \cdot 10^{-4}}{7351} = 3.008 \cdot 10^{-8} \text{ m}^3/\text{Pa}$$

$$C_{v2}(p) = \frac{V_2}{p} = \frac{1.099 \cdot 10^{-4}}{7351} = 1.494 \cdot 10^{-8} \text{ m}^3/\text{Pa}$$

$$C_v = C_{v1} + C_{v2} = 3.008 \cdot 10^{-8} + 1.494 \cdot 10^{-8} = 4.503 \cdot 10^{-8} \text{ m}^3/\text{Pa}$$

$$p_1 = \frac{C_v(p_p + \Delta p_{\text{met}} - c_2 \cdot \Delta H) - V_{01} + \sqrt{[V_{01} - C_v(p_p + \Delta p_{\text{met}} - c_2 \cdot \Delta H)]^2 + 4C_v \frac{p_p V_{01} T_1}{T_p}}}{2C_v} = 108349 \text{ Pa}$$

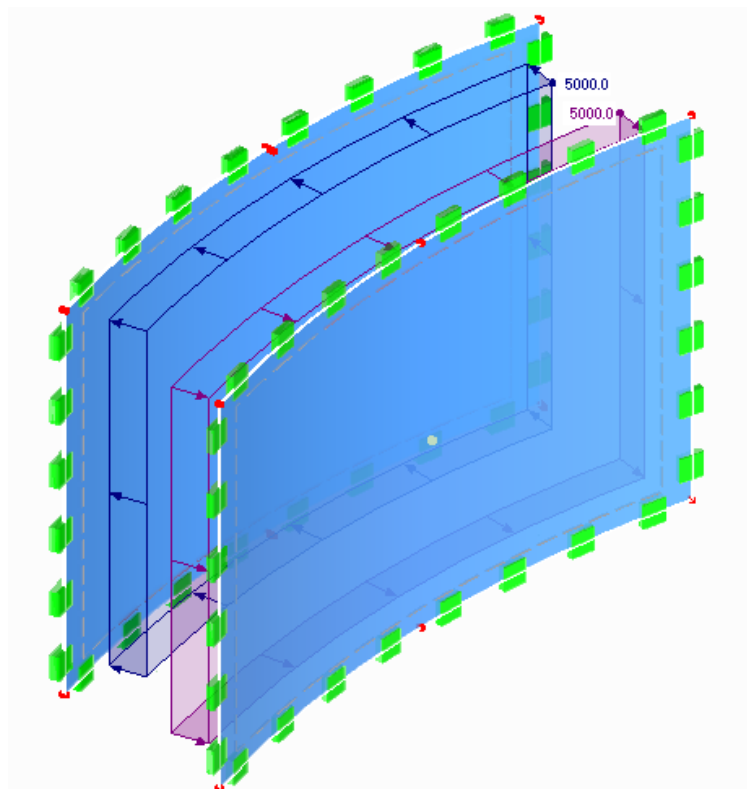

Figure 8.40: RFEM model

### 3. Iteration step

The procedure of the next steps is the same. Therefore, only the most important values are quoted.

$$p = p_1 - p_{\text{out}} = 108349 - 101000 = 7349 \text{ Pa}$$

$$w_1 = -0.265 \text{ mm}, w_2 = 0.123 \text{ mm}$$

$$V_1 = 2.210 \cdot 10^{-4} \text{ m}^3, V_2 = 1.098 \cdot 10^{-4} \text{ m}^3$$

$$C_v = C_{v1} + C_{v2} = 3.008 \cdot 10^{-8} + 1.494 \cdot 10^{-8} = 4.502 \cdot 10^{-8} \text{ m}^3/\text{Pa}$$

$$p_1 = 108349 \text{ Pa}$$

Because the results in the second and third iteration steps are identical, the iteration process is terminated. Thus, the maximum deflections are

$$w_1 = -0.265 \text{ mm}, w_2 = 0.123 \text{ mm}.$$

The result values in RF-GLASS are  $w_1 = -0.265 \text{ mm}$  and  $w_2 = 0.123 \text{ mm}$ , thus confirming the results.

## 9. Appendix A

### 9.1 Stiffness Matrix Check for Positive Definiteness

The stiffness matrix which is given in the form:

$$\mathbf{D}_{8 \times 8} = \begin{bmatrix}
 D_{11} & D_{12} & 0 & 0 & 0 & D_{16} & D_{17} & 0 \\
 & D_{22} & 0 & 0 & 0 & \text{sym.} & D_{27} & 0 \\
 & & D_{33} & 0 & 0 & \text{sym.} & \text{sym.} & D_{38} \\
 & & & D_{44} & 0 & 0 & 0 & 0 \\
 & & & & D_{55} & 0 & 0 & 0 \\
 & \text{sym.} & & & & D_{66} & D_{67} & 0 \\
 & & & & & & D_{77} & 0 \\
 & & & & & & & D_{88}
 \end{bmatrix}$$

is checked for the following conditions:

- Matrix  $\mathbf{D}$  is positive definite (i.e., all of the leading principal minors must be positive. As a consequence, there are positive values on the diagonal:  $D_{ij} > 0, i = 1, \dots, n$ .)
- Moreover, it is required that (positive definiteness in a more restrictive sense):

$$\det \begin{bmatrix} D_{11} & D_{12} \\ D_{12} & D_{22} \end{bmatrix} \geq c D_{11} D_{22}$$

$$\det \begin{bmatrix} D_{66} & D_{67} \\ D_{67} & D_{77} \end{bmatrix} \geq c D_{66} D_{77}$$

$$c = 1 - 0.999^2 = 0.001999$$

# A Literature

- [1] TRLV. *Technische Regeln für die Verwendung von linienförmig gelagerten Verglasungen*. August 2006. 9 p.
- [2] WELLER, Bernhard, et al. *Glasbau-Praxis : Konstruktion und Bemessung*. Berlin : Bauwerk, 2009. 263 p. ISBN 978-3-89932-190-6.
- [3] WELLER, Bernhard, et al. *Glasbau-Praxis in Beispielen : Konstruktion und Berechnung*. Berlin : Bauwerk, 2005. 150 p. ISBN 3-934369-47-2.
- [4] DIN 18008-1. *Glas im Bauwesen — Bemessungs- und Konstruktionsregeln — Teil 1: Begriffe und allgemeine Grundlagen*. Dezember 2010. 14 p.
- [5] DIN 18008-2. *Glas im Bauwesen — Bemessungs- und Konstruktionsregeln — Teil 2: Linienförmig gelagerte Verglasungen*. Dezember 2010. 13 p.
- [6] OFNER, Robert. *Leichtbau und Glasbau: Bemessung von Glaskonstruktionen*, Vorlesungsskript. Technische Universität Graz, Institut für Stahlbau, Holzbau und Flächentragwerke, Wintersemester 2003/2004.
- [7] David R. LIDE, ed. *CRC Handbook of Chemistry and Physics, 89th Edition (Internetversion 2009)*, CRC Press/Taylor and Francis, Boca Raton, FL.



# B Index

<b>A</b>			
Accidental.....	22		
Action combination.....	51, 52, 53		
Altitude.....	35		
Atmospheric pressure.....	35		
<b>B</b>			
Bach.....	44		
Boundary members.....	34		
Browsing through module windows.....	17, 55		
<b>C</b>			
Calculation.....	17, 39		
Calculation type.....	18		
Characteristic.....	23, 62		
Climatic load parameter.....	35, 81, 97		
Comment.....	21		
Construction factor.....	50		
Coordinates.....	56		
Curved insulating glass.....	92		
<b>D</b>			
Decimal places.....	68		
Deflection.....	23, 51, 52, 53		
Design of.....	18		
Design situation.....	22, 50, 52, 62		
Details.....	17, 39		
Details of composition.....	24, 46, 82		
Diagram.....	57, 67		
DIN 18008.....	49		
DIN 18008-2, Annex A.....	36, 89		
Displacements.....	62		
<b>E</b>			
Equivalent stress.....	44		
Exit RF-GLASS.....	17, 55		
Export.....	26, 30		
Export results.....	69		
<b>F</b>			
FE mesh points.....	45, 47, 56, 59		
Filter.....	24, 59, 61		
Foil.....	9		
Frequent.....	23, 62		
<b>G</b>			
Gas pressure.....	63		
General data.....	17		
Global calculation.....	18, 20		
Graphic printout.....	65		
Graphics.....	17, 18, 26, 30		
Grid points.....	45, 56, 59		
<b>H</b>			
Horizontal glazing.....	24		
<b>I</b>			
Import.....	26		
Installation.....	6		
Insulating glass.....	10, 25, 35, 48, 51, 76		
<b>K</b>			
Kirchhoff.....	47		
<b>L</b>			
Laminated glass.....	9, 46		
Layer.....	23, 56		
Limit stress.....	49, 51, 52, 57		
Limit values.....	23		
Line support reactions.....	60		
Line supports.....	27, 80, 96		
Load case.....	17, 21, 22, 37		
Load distribution.....	36		
Load duration.....	37		
Local calculation.....	10, 18, 19, 27, 79, 95		
<b>M</b>			
Manufacturing.....	35		
Material library.....	24, 25		
Max stress/ratio by loading.....	56		
Max stress/ratio by surface.....	58		
Method of analysis.....	46		
Mindlin.....	47		
Mises, von.....	44		
Modification factor.....	37, 50		
Module windows.....	17		
Mount.....	35		
<b>N</b>			
Navigator.....	17, 55		
NEWTON-RAPHSON.....	46		
Nodal support.....	31		
Nodal support reactions.....	61		

<b>P</b>			
Panel.....	7		
Partial safety factor.....	22, 50, 52		
Parts list.....	63		
Persistent and transient.....	22		
Plate bending theory.....	47		
Positive definiteness.....	103		
Printout report.....	57, 65, 66, 67		
<b>Q</b>			
Quasi-permanent.....	23, 62		
<b>R</b>			
Rankine.....	44		
Ratio.....	57, 62		
Reference length.....	62		
Relation scale.....	55		
Results.....	45, 55		
<b>S</b>			
Save temporary model.....	47		
Secondary seal.....	10		
Serviceability.....	51, 52, 53		
Serviceability data.....	38		
Shear coupling between layers.....	9, 12, 14, 47		
Standard.....	18, 49		
Start calculation.....	54		
Start RF-GLASS.....	6		
Stiffness matrix.....	12		
Stiffness matrix elements.....	13, 71		
Stiffness reduction.....	47		
Stress distribution.....	67		
Stresses.....	40, 57		
Stresses in all points.....	59		
Symbols.....	8		
<b>T</b>			
Temperature.....	35		
Tresca.....	44		
TRLV.....	51		
TRLV, Annex A.....	24, 36, 89		
<b>U</b>			
Units.....	68		
User profile.....	68		
<b>V</b>			
Vertical glazing.....	24		
View mode.....	55		